

**General Safety Instructions:**

READ SAFETY INSTRUCTIONS

**Servicing:**

These products are not customer serviceable TDK-Lambda UK LTD and their authorised agents only are permitted to carry out repairs.

**Critical Components:**

These products are not authorised for use as critical components in nuclear control systems, life support systems or equipment for use in hazardous environments without the express written approval of the Managing Director of TDK-Lambda EMEA.

**Product Usage:**

These products are designed for use within a host equipment which restricts access to authorised competent personnel.

This product is a component power supply and is only to be installed by qualified persons within other equipment and must be not operated as a stand alone product.

This product is for sale to business to business customers and can be obtained via distribution channels.

It is not intended for sale to end users.

This product is a component power supply and does not fall within the scope of the EMC directive. Compliance with the EMC directive must be considered in the final installation. Please contact your local TDK-Lambda office.

**Environmental:**

These products are IPX0, and therefore chemicals/solvents, cleaning agents and other liquids must not be used.

**Environment:**

This power supply is a switch mode power supply for use in applications within a Pollution Degree 2, overvoltage category II environment. Material Group IIIb PCB's are used within it.

**Output Loading:**

The output power taken from the power supply must not exceed the rating stated on the power supply label, except as stated in the product limitations in this handbook.

**Input Parameters:**

This product must be operated within the input parameters stated in the product limitations in this handbook.

**End of Life Disposal:**

The unit contains components that require special disposal. Make sure that the unit is properly disposed of at the end of its service life and in accordance with local regulations.



RISK OF ELECTRIC SHOCK

**High Voltage Warning:**

Dangerous voltages are present within the power supply. The professional installer must protect service personnel from inadvertent contact with these dangerous voltages in the end equipment.

**WARNING:** When installed in a Class 1 end equipment, this product must be reliably earthed and professionally installed.

The (+) or (-) output(s) can be earthed or left floating.

The unit cover(s)/chassis (where applicable) must not be made user accessible.

The mains input connector is not acceptable for use as field wiring terminals.

For encased products, do not use mounting screws, which penetrate the unit more than; See drawings.

Internal fuses protect the unit and must not be replaced by the user. In case of internal defect, the unit must be returned to TDK-Lambda UK LTD or one of their authorised agents.

A suitable mechanical, electrical and fire enclosure must be provided by the end use equipment for mechanical, electric shock and fire hazard protection.

**Energy Hazards:**

The main output of this product is capable of providing hazardous energy (240VA). Final equipment manufacturers must provide protection to service personnel against inadvertent contact with the output terminals.

The unit cover/chassis, where applicable, is designed to protect skilled personnel from hazards. They must not be used as part of the external covers of any equipment where they may be accessible to operators, since under full load conditions, part or parts of the unit chassis may reach temperatures in excess of those considered safe for operator access.

**Allgemeine Sicherheitsvorschriften:**

LESEN SIE DIE SICHERHEITSVORSCHRIFTEN

**Wartung:**

Diese Produkte können nicht durch den Kunden gewartet werden. Nur TDK-Lambda UK LTD. und deren zugelassene Vertriebshändler sind zur Durchführung von Reparaturen berechtigt.

**Kritische Komponenten:**

Diese Produkte sind nicht für die Verwendung als kritische Komponenten in nuklearen Kontrollsystemen, Lebenserhaltungssystemen oder Geräten in gefährlichen Umgebungen geeignet, sofern dies nicht ausdrücklich und in Schriftform durch den Geschäftsführer von TDK-Lambda EMEA genehmigt wurde.

**Produktverwendung:**

Diese Produkte sind zur Verwendung innerhalb von Host-Anlagen gedacht, die einen auf das Fachpersonal beschränkten Zugang haben.

Dieses Produkt ist eine Stromversorgungs-Komponente und sie darf nur von qualifiziertem Personal in andere Geräte eingebaut werden und sie darf NICHT als eigenständiges ("Stand-Alone") Gerät betrieben werden. Dieses Produkt ist für den Verkauf an Geschäftskunden entwickelt worden und es kann über Distributionskanäle bezogen werden.

Es ist NICHT für den Verkauf an Endkunden gedacht und konzipiert.

Dieses Produkt ist eine Stromversorgungsbaugruppe und sie fällt NICHT in den Bereich der EMV Direktive. Die Konformität mit der EMV Richtlinie muss in der finalen Gesamtinstallation betrachtet werden. Bitte kontaktieren Sie Ihr regionales TDK-Lambda Vertriebsbüro im Falle von Rückfragen.

**Umwelt:**

Diese Produkte sind IPX0, aus diesem Grund dürfen keine Chemikalien/Lösungsmittel, Reinigungsmittel und andere Flüssigkeiten verwendet werden.

**Umgebung:**

Dieses Netzteil ist ein Schaltnetzteil zur Verwendung in einer Umgebung mit einem Verschmutzungsgrad 2, Überspannungskategorie II. Materialgruppe IIIb mit darin verwendeten PCBs.

**Ausgangsstrom:**

Der Ausgangsstrom des Netzteiles darf die Leistung, die auf dem Label des Netzteiles vermerkt ist, nur dann überschreiten, wenn dies in den Produktgrenzen dieses Handbuches ausgezeichnet ist.

**Eingangsparameter:**

Dieses Produkt muss innerhalb der Eingangsparameter, die in den Produktgrenzen dieses Handbuches angegeben sind, betrieben werden.

**Entsorgung am Ende der Betriebszeit:**

Das Gerät enthält Komponenten die unter Sondermüll fallen. Das Gerät muss am Ende der Betriebszeit ordnungsgemäß und in Übereinstimmung mit den regionalen Bestimmungen entsorgt werden.

**GEFAHR DURCH ELEKTRISCHEN SCHLAG****Hochspannungswarnung:**

Innerhalb des Netzteiles gibt es gefährliche Spannungen. Der Elektroinstallateur muss das Wartungspersonal vor versehentlichem Kontakt mit den gefährlichen Spannungen im Endgerät schützen.

**WARNUNG!** Falls Sie unser Netzgerät in eine Anwendung mit Schutzklasse 1 eingebaut haben, stellen Sie sicher, dass es fachgerecht installiert und zuverlässig geerdet ist.

Die (+) oder (-) Ausgänge können geerdet werden oder unangeschlossen bleiben.

Die Abdeckung des Gerätes/das Gehäuse darf für den Benutzer nicht zugänglich sein.

Der Haupteingangsanschluss ist nicht für die Verwendung als Feldverdrahtungsanschluss geeignet.

Für ummantelt Produkte, verwenden Sie keine Schrauben, die das Gerät mehr als durchdringen; siehe Zeichnung. Eine interne Sicherung schützt das Gerät und darf durch den Benutzer nicht ausgetauscht werden. Im Fall von internen Defekten muss das Gerät an TDK-Lambda UK LTD oder einen der autorisierten Vertriebs Händler zurückgeschickt werden.

Ein geeignetes mechanisches, elektrisches und brandgeschütztes Gehäuse muss als Schutz vor der Gefahr von mechanischen Risiken, Stromschlägen und Brandschutz in dem Endgerät vorgesehen werden.

Gefahren durch elektrische Energie:

Von bestimmten Modulen kann je nach Einstellung der Ausgangsspannung gefährliche elektrische Energie ausgehen (240 VA). Die Endgerätehersteller müssen einen Schutz für Servicepersonal vor unbeabsichtigtem Kontakt mit den Ausgangsanschlüssen dieser Module vorsehen. Kann aufgrund der Einstellung gefährliche elektrische Energie auftreten, dürfen die Modulanschlüsse für den Benutzer nicht zugänglich sein.

Die Geräteabdeckung/das Gehäuse ist so entworfen, dass das Fachpersonal vor Gefahren geschützt wird. Sie dürfen nicht als Teil der externen Abdeckung für Geräte verwendet werden, die für den Betreiber zugänglich sein müssen, da Teile oder das gesamte Gerätegehäuse unter voller Auslastung übermäßige Temperaturen erreichen kann, die für den Zugang des Betreibers nicht mehr als sicher betrachtet werden.

**Consignes générales de sécurité:**

LIRE LES CONSIGNES DE SECURITE

**Entretien:**

Ces produits ne peuvent pas être réparés par l'utilisateur. Seuls, TDK-Lambda UK LTD et ses agents agréés sont autorisés à effectuer des réparations.

**Composants critiques:**

Ces produits ne doivent pas être utilisés en tant que composants critiques dans des systèmes de commande nucléaire, dans des systèmes de sauvetage ou dans des équipements utilisés dans des environnements dangereux, sans l'autorisation écrite expresse du directeur général de TDK-Lambda EMEA.

**Utilisation du produit:**

Ces produits sont conçus pour être utilisés dans un équipement hôte dont l'accès n'est autorisé qu'aux personnes compétentes.

Ce produit est une alimentation considérée comme un composant devant être installé par des personnes qualifiées, dans un autre équipement. Il ne doit pas être utilisé en tant que produit fini.

Ce produit est destiné à la vente entre entreprises et peut être obtenu via des canaux de distribution.

Il n'est pas prévu à la vente pour les particuliers.

Ce produit est une alimentation considérée comme un composant, il ne relève pas du champ d'application de la directive CEM. Le respect de la directive CEM doit être pris en compte dans l'installation finale. Veuillez contacter votre bureau TDK-Lambda le plus proche.

**Environnement:**

Ces produits sont IPX0, et donc on ne doit pas utiliser des produits chimiques/solvants, des produits de nettoyage et d'autres liquides.

**Environnement fonctionnel :**

Cette alimentation fonctionne en mode commutation pour utilisation dans des applications fonctionnant dans un environnement avec Degré de Pollution 2 et catégorie de surtension II. Elle utilise des cartes des circuits imprimés (PCB) de Groupe IIIb.

**Intensité soutirée:**

L'intensité soutirée de l'alimentation ne doit pas dépasser l'intensité nominale marquée sur la plaque signalétique, sauf indications contraires dans les limitations du produit décrit dans ce manuel.

**Paramètres d'entrée:**

Ce produit doit être utilisé à l'intérieur des paramètres d'entrée indiqués dans les limitations du produit dans ce manuel.

**Elimination en fin de vie:**

L'alimentation contient des composants nécessitant des dispositions spéciales pour leur élimination. Vérifiez que cette alimentation est mise au rebut correctement en fin de vie utile et conformément aux réglementations locales en vigueur.

RISQUE DE CHOC ELECTRIQUE

**Attention-Danger haute tension:**

Des tensions dangereuses sont présentes dans l'alimentation. L'installateur doit protéger le personnel d'entretien contre un contact involontaire avec ces tensions dangereuses dans l'équipement final.

**AVERTISSEMENT:** Si ce produit est installé dans un équipement final de classe I, il doit être mis à la terre de manière fiable et installé par un professionnel averti.

Les sorties (+) ou (-) peuvent être raccordées à la terre ou laissées flottantes.

Le couvercle/châssis de l'alimentation ne doit pas être accessible à l'utilisateur. Le connecteur d'entrée d'alimentation principale ne doit pas être utilisé comme borne de raccordement.

N'utilisez pas de vis pénétrant dans le module sur une profondeur supérieure à : Voir dessins.

Un fusible interne protège le module et ne doit pas être remplacé par l'utilisateur. En cas de défaut interne, le module doit être renvoyé à TDK-Lambda UK LTD ou l'un de ses agents agréés.

Une enceinte appropriée doit être prévue par l'utilisateur final pour assurer la protection contre les chocs mécaniques, les chocs électriques et l'incendie.

Energies dangereuses :

Certains modules peuvent générer une énergie dangereuse (240 VA) selon le réglage de tension de sortie. Le fabricant de l'équipement final doit assurer la protection des techniciens d'entretien contre un contact involontaire avec les bornes de sortie de ces modules. Si une telle tension dangereuse risque de se produire, les bornes ou les connexions du module ne doivent pas être accessibles par l'utilisateur.

Le couvercle et le châssis du module sont conçus pour protéger des personnels expérimentés. Ils ne doivent pas être utilisés comme couvercles extérieurs d'un équipement, accessible aux opérateurs car en condition de puissance maximum, des parties du châssis peuvent atteindre des températures considérées comme dangereuses pour l'opérateur.

**Norme generali di sicurezza:**

SI PREGA DI LEGGERE LE NORME DI SICUREZZA

**Manutenzione:**

Il cliente non può eseguire alcuna manutenzione su questi prodotti. L'esecuzione delle eventuali riparazioni è consentita solo a TDK-Lambda UK LTD e ai suoi agenti autorizzati.

**Componenti critici:**

Non si autorizza l'uso di questi prodotti come componenti critici all'interno di sistemi di controllo nucleari, sistemi necessari alla sopravvivenza o apparecchiature destinate all'impiego in ambienti pericolosi, senza l'esplicita approvazione scritta dell'Amministratore Delegato di TDK-Lambda EMEA.

**Uso dei prodotti:**

Questi prodotti sono progettati per l'uso all'interno di un'apparecchiatura ospite che limiti l'accesso al solo personale competente e autorizzato.

Questo prodotto è da considerarsi come un alimentatore professionale componente e come tale deve essere installato da personale qualificato all'interno di altre apparecchiature e non può essere utilizzato come prodotto indipendente.

Questo prodotto non è inteso per la vendita al dettaglio o agli utilizzatori finali.

Questo alimentatore è da considerarsi come un componente e come tale non è assoggettato dagli scopi della direttiva EMC. Conformità alla direttiva EMC deve essere considerata nell'installazione finale di utilizzo. Gli uffici di TDK-Lambda Sas Succursale Italiana sono a vostra disposizione per ulteriori raggugli.

**Condizioni ambientali:**

Questi prodotti sono classificati come IPX0, dunque non devono essere utilizzati sostanze chimiche/solventi, prodotti per la pulizia o liquidi di altra natura.

**Ambiente:**

Questo prodotto è un alimentatore a commutazione, destinato all'uso in applicazioni rientranti in ambienti con le seguenti caratteristiche: Livello inquinamento 2, Categoria sovratensione II. Questo prodotto contiene schede di circuiti stampati in materiali di Gruppo IIIb.

**Carico in uscita:**

La potenza in uscita ottenuta dall'alimentatore non deve superare la potenza nominale indicata sulla targhetta dell'alimentatore, fatto salvo dove indicato nei limiti per il prodotto specificati in questo manuale.

**Parametri di alimentazione:**

Questo prodotto deve essere utilizzato entro i parametri di alimentazione indicati nei limiti per il prodotto, specificati in questo manuale.

**Smaltimento:**

L'unità contiene componenti che richiedono procedure speciali di smaltimento. Accertarsi che l'unità venga smaltita in modo corretto al termine della vita utile e nel rispetto delle normative locali.

**RISCHIO DI SCOSSA ELETTRICA****Avvertimento di alta tensione:**

All'interno dell'alimentatore sono presenti tensioni pericolose. Gli installatori professionali devono proteggere il personale di manutenzione dal rischio di contatto accidentale con queste tensioni pericolose all'interno dell'apparecchiatura finale.

**ATTENZIONE:** Se installato in un'attrezzatura di classe I, questo prodotto deve essere collegato a terra in modo affidabile ed installato in modo professionale.

Le uscite (+) o (-) possono essere messa a terra o lasciate isolate.

I coperchi/il telaio dell'unità non devono essere accessibili da parte dell'utente.

Il connettore dell'alimentazione principale non può essere utilizzato come terminale di collegamento di campo.

Non utilizzare viti che penetrano nell'unità per più di : Vedi disegni

Un fusibile interno protegge l'unità e non deve essere sostituito dall'utente. Nell'eventualità di un difetto interno, restituire l'unità a TDK-Lambda UK LTD o a uno dei suoi agenti autorizzati.

L'apparecchiatura finale deve includere una recinzione meccanica, elettrica e antincendio per proteggere dai pericoli di natura meccanica, dalle scosse elettriche e dai pericoli di incendio.

Pericoli energetici:

Alcuni moduli sono in grado di erogare energia pericolosa (240 VA) a seconda della tensione in uscita impostata. I produttori delle apparecchiature finali sono tenuti a proteggere il personale di manutenzione dal rischio di contatto accidentale con questi terminali dei moduli di uscita. Se impostati su livelli che non escludono l'erogazione di energia pericolosa, questi terminali o collegamenti non devono risultare accessibili da parte dell'utente.

Il coperchio/telaio dell'unità è realizzato per proteggere il personale esperto dai pericoli. Non deve essere usato come parte degli involucri esterni di qualsiasi apparecchiatura, se risulta accessibile da parte degli addetti, poiché è possibile che in condizioni di pieno carico una o più parti del telaio dell'unità giunga/ giungano a temperature superiori ai limiti considerati sicuri per l'accesso da parte degli addetti.



**Instrucciones generales de seguridad:**

LEA LAS INSTRUCCIONES DE SEGURIDAD

**Servicio:**

Estos productos no pueden ser reparados por los clientes. TDK-Lambda UK LTD. y sus agentes autorizados son los únicos que pueden llevar a cabo las reparaciones.

**Componentes fundamentales:**

Estos productos no pueden ser utilizados como componentes fundamentales en sistemas de control nuclear, sistemas de soporte vital o equipos a utilizar en entornos peligrosos sin el consentimiento expreso por escrito del Director General de TDK-Lambda EMEA.

**Uso de los productos:**

Estos productos han sido diseñados para ser utilizados en un equipo central que restrinja el acceso al personal cualificado autorizado.

Este producto es una fuente de alimentación y sólo puede ser instalado por personal cualificado dentro de otros equipos y no debe ser tratado como un producto independiente. Este producto debe ser vendido entre empresas profesionales y solo puede obtenerse a través de los canales de distribución. No está destinado para la venta a usuarios finales

Este producto es una fuente de alimentación y no se ve afectada por la directiva EMC. El cumplimiento de la directiva EMC se debe considerar en la instalación final. Por favor, póngase en contacto con su oficina local de TDK – Lambda.

**Medioambiental:**

Estos productos son IPX0 y, por tanto, no pueden utilizarse sustancias químicas/disolventes, agentes de limpieza ni otros líquidos.

**Medio ambiente:**

Esta fuente de alimentación es una fuente de alimentación de modo conmutado a utilizar en aplicaciones dentro de un entorno con un Grado de contaminación 2 y una Categoría de sobretensión II. En él se utilizan policloruros de bifenilo del Grupo de materiales IIIb.

**Carga de salida:**

La potencia de salida tomada de la fuente de alimentación no puede sobrepasar el valor nominal indicado en la etiqueta de la fuente de alimentación, excepto en los casos indicados en las limitaciones del producto en este manual.

**Parámetros de entrada:**

Este producto debe ser utilizado dentro de los parámetros de entrada indicados en las limitaciones del producto en este manual.

**Desecho de la unidad:**

La unidad contiene componentes que deben ser desechados de una manera especial. Asegúrese de desechar correctamente la unidad al final de su vida útil y conforme a las normas locales vigentes.

**PELIGRO DE DESCARGAS ELÉCTRICAS****Advertencia de alta tensión:**

En esta fuente de alimentación hay tensiones peligrosas. El instalador profesional debe proteger al personal de servicio contra cualquier contacto accidental con estas tensiones peligrosas en el equipo final.

**ADVERTENCIA:** La instalación de este producto en un equipo de clase I la deben llevar a cabo profesionales y el producto debe estar conectado a tierra.

La salida o salidas (+) o (-) pueden conectarse a tierra o se las puede dejar flotando.

Debe impedirse el acceso de los usuarios a la cubierta o cubiertas y al chasis de la unidad.

El conector de entrada de la red no es apto para ser utilizado a modo de bornes de cableado de campo.

No utilice tornillos de montaje susceptibles de penetrar en la unidad más de: Ver dibujos.

Un fusible interno protege la unidad y este no debe ser nunca reemplazado por el usuario. En caso de existir algún defecto interno, la unidad debe ser enviada a TDK-Lambda UK LTD o a uno de sus agentes autorizados.

El equipo de uso final debe constituir un recinto de protección mecánica, eléctrica y contra incendios de protección mecánica, contra descargas eléctricas y contra el peligro de incendios.

Peligros de energía:

Algunos módulos pueden generar energía peligrosa (240VA) dependiendo de la configuración de la tensión de salida. Los fabricantes de equipos finales deben proteger al personal de servicio contra un contacto accidental con estos bornes de salida de los módulos. Si se configura de modo que pueda generarse energía peligrosa, hay que evitar que el usuario pueda acceder a los bornes o conexiones del módulo.

La cubierta/chasis de la unidad ha sido diseñada para que proteja a las personas cualificadas de los peligros. No deben ser utilizadas como parte de las cubiertas externas de cualquier equipo al que pueden acceder los operarios, ya que bajo unas condiciones de carga completa, la pieza o piezas del chasis de la unidad pueden alcanzar temperaturas superiores a las consideradas seguras para el acceso de los operarios.

**Instruções gerais de segurança:**

LEIA AS INSTRUÇÕES DE SEGURANÇA

**Manutenção:**

Estes produtos não são podem ser submetidos a manutenção por parte do cliente. Apenas a TDK-Lambda UK LTD e os seus agentes autorizados têm permissão para realizar reparações.

**Componentes essenciais:**

Não é autorizada a utilização destes produtos como componentes essenciais de sistemas de controlo nuclear, sistemas de suporte de vida ou equipamento para utilização em ambientes perigosos sem a expressa autorização por escrito do Director-Geral da TDK-Lambda EMEA.

**Utilização do produto:**

Estes produtos foram concebidos para utilização dentro de um equipamento de alojamento que apenas permita o acesso a pessoal qualificado autorizado.

Este produto é uma alimentação considerado com um componente para ser instalado por pessoas qualificadas, em outros equipamentos. Não deve ser usado como um produto acabado.

Este produto é destinado para venda entre as empresas e pode ser obtido através de canais de distribuição. Não se destina à venda aos particulares.

Este produto é uma alimentação considerado com um componente, não é dentro do application âmbito da directiva CEM.

Conformidade com a directiva CEM devem ser considerados na instalação final.

Entre em contacto com seu escritório TDK-Lambda mais próximo.

**Ambiental:**

Estes produtos são IPX0 e, como tal, não se devem utilizar químicos/solventes, agentes de limpeza e outros líquidos.

**Ambiente:**

Esta fonte de alimentação é uma fonte de alimentação do modo de comutação para utilização em aplicações com um Nível de Poluição 2 e ambientes da categoria de sobretensão II. São utilizadas placas de circuitos impressos do grupo de materiais IIIb.

**Carga de saída:**

A potência de saída extraída da fonte de alimentação não deve exceder a classificação assinalada na etiqueta da fonte de alimentação, excepto quando indicado nas limitações do produto neste guia.

**Parâmetros de entrada:**

Este produto deve ser utilizado dentro dos parâmetros de entrada indicados nas limitações do produto neste guia.

**Eliminação no fim de vida:**

A unidade contém componentes que necessitam de procedimentos especiais de eliminação. Certifique-se de que a unidade é devidamente eliminada no fim da sua vida útil e que tal é feito em conformidade com os regulamentos locais.

**RISCO DE CHOQUE ELÉCTRICO****Aviso de alta tensão:**

Estão presentes tensões perigosas dentro da fonte de alimentação. O profissional que realizar a instalação deve proteger o pessoal de assistência contra contactos inadvertidos com estas tensões perigosas do equipamento final.

**AVISO:** Quando instalado num equipamento de Classe I, este produto deve ser ligado à terra de forma fiável e instalado por um profissional.

As saídas (+) e (-) podem ser ligadas à terra ou deixadas soltas.

O chassis/cobertura(s) da unidade não deve estar acessível ao utilizador.

O conector de entrada de alimentação não deve ser utilizado como terminal de cablagens no local.

Não utilize parafusos de montagem, uma vez que estes penetrarão na unidade em mais do que: Veja os desenhos

Existe um fusível interno que protege a unidade e que não deve ser substituído pelo utilizador. Em caso de defeito interno, a unidade deve ser devolvida à TDK-Lambda UK LTD ou a um dos seus agentes autorizados.

O equipamento de utilização final deve fornecer um bastidor com protecção mecânica, eléctrica e contra incêndios adequada.

Perigos de energia:

Alguns módulos tem a capacidade de fornecer energia perigosa (240 VA), de acordo com a configuração da tensão de saída. O equipamento final do fabricante deve garantir que o pessoal de assistência está protegido contra contactos inadvertidos com estes terminais de saída do módulo. Se essa energia perigosa for produzida, as ligações e os terminais do módulo não devem ser acessíveis pelos utilizadores.

O chassis/cobertura da unidade está concebido de forma a proteger o pessoal especializado de perigos. Não devem ser utilizados como parte das coberturas externas de qualquer equipamento em que possam estar acessíveis aos operadores, uma vez que em condições de carga máxima, algumas peças do chassis da unidade podem atingir temperaturas superiores às consideradas seguras para o acesso do operador.

## **TDK-Lambda**

TDK-Lambda UK Ltd

Kingsley Avenue, Ilfracombe

Devon, EX34 8ES

Telephone - Sales and Service +44 (0)1271 856666

Head Office and Works +44 (0)1271 856600

Facsimile +44 (0)1271 864894

WEBSITE: [www.uk.tdk-lambda.com](http://www.uk.tdk-lambda.com)

# CUS350M Series

## Instruction Manual

### BEFORE USING THE POWER SUPPLY UNIT

Be sure to read this instruction manual thoroughly before using this product. Pay attention to all cautions and warnings before using this product. Incorrect usage could lead to an electrical shock, damage to the unit or a fire hazard.

#### DANGER

Never use this product in locations where flammable gas or ignitable substances are present. There are risks of igniting these substances and exploding by an arcing.

#### WARNING

- Do not touch this product or its internal components while circuit is live, or shortly after shut down. There may be high voltage or high temperature present and you may receive an electric shock or burn.
- When this product is operating, keep your hands and face away from it as you may be injured by an unexpected situation.
- Do not make unauthorized changes to this product, otherwise you may receive an electric shock and void your warranty.
- Do not drop or insert anything into this product. It might cause a failure, fire and electric shock.
- Do not use this product under unusual condition such as emission of smoke or abnormal smell and sound etc. It might lead to fire and electric shock. In such cases, please contact us. Do not attempt repair by yourself, as it is dangerous for the user.
- Do not operate these products in the presence of condensation. It might lead fire or electric shock.

#### CAUTION

- This power supply is designed and manufactured for use within an end product such that it is accessible to SERVICE ENGINEERS only.
- Confirm connections to input/output terminals are correct as indicated in the instruction manual before switching on.
- Input voltage, Output current, Output power, ambient temperature and ambient humidity should be kept within specifications, otherwise the product will be damaged.
- Do not operate and store this product in an environment where condensation might occur. In such case, waterproof treatment is necessary.
- Do not use this product in environment with a strong electromagnetic field, corrosive gas or conductive substances.
- For applications, which require very high reliability (Nuclear related equipment, traffic control equipment, etc.), it is necessary to provide a fail-safe mechanism in the end equipment.
- Do not inject abnormal voltages into the output of this product. The injection of reverse voltage or over voltage exceeding nominal output voltage into the output terminal might cause damage to internal components.
- Never operate the product under over current or short-circuit conditions for more than 30 seconds, or outside its specified Input Voltage Range. Insulation failure, smoking, burning or other damage may occur.
- The power supply has possibility that hazardous voltage may occur in output terminal depending on failure mode. The output of these products must be protected in the end use equipment to maintain SELV.
- This product has used Power Thermistor to protect the circuit from Inrush Current. Frequent repetition of input on/off might cause damage to internal components because of generating surge current.
- Breaking of internal fuse is considered internal failure. In such cases, please contact us.
- The information in this document is subject to change without prior notice. Please refer to the latest version of the data sheet, etc., for the most up-to date specifications of the product.
- No part of this document may be copied or reproduced in any form without prior written consent of TDK-Lambda.

#### Note: CE MARKING

CE marking, when applied to a product covered by this handbook, indicates compliance with the low voltage directive.

## 1. Model name identification method

CUS 350 M-12 □

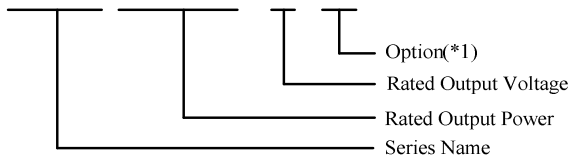

(\*1)  
 Blank : Standard Model  
 /F: Full Function  
 /FN : with Fan Supply Model  
 /PG : with Power Good Model  
 /Others: Denotes for market purpose,  
 no construction difference and  
 no safety impact,  
 such as /0-/9, /a-/z etc.

## 2. Terminal Explanation

### 2-1. Terminal Explanation

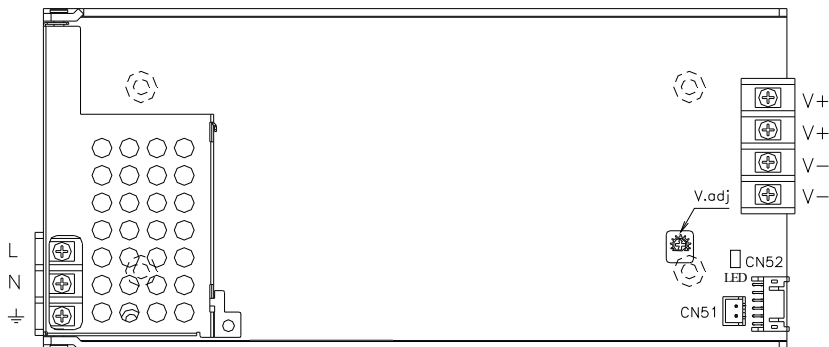

- ① L : Input terminal Live line (fuse in line.), M3 screw.
- ② N : Input terminal Neutral line (fuse in line.), M3 screw.
- ③  $\text{⏏}$  : Earth terminal M3 screw.
- ④ V.adj: Output voltage adjustment trimmer. The output voltage rises when the trimmer is turned clockwise.
- ⑤ V+ : + Output Terminal, (20A max./terminal, M3 screw.)
- ⑥ V- : - Output Terminal, (20A max./terminal, M3 screw.)
- ⑦ LED : Output monitoring indicator (SMD type, Green color).

### 2-2. CN51 Connector pin Configuration and Function

CN51	Pin No.	Configuration	Function
	1	Fan Supply +	+ 12V, 0.3A max. for fan supply etc.
	2	Fan Supply -	Return of fan supply

### 2-3. CN52 Connector pin Configuration and Function

CN52	Pin No.	Configuration	Function
	1	STBY +	+5V, 0.5A max. for standby mode power
	2	STBY -	Return of standby mode power
	3	NC	NO CONNECTION
	4	NC	NO CONNECTION
	5	R-	Remote ON/OFF control terminal -
	6	R+	Remote ON/OFF control terminal +
	7	PG-	Return of power good terminal
	8	PG+	Power good terminal
	9	NC	NO CONNECTION
	10	TOVP	OVP test terminal(only for internal test)
	11	S-	Remote sensing terminal for -output terminal
	12	S+	Remote sensing terminal for +output terminal

\*CN51, CN52 Connector & Housing & Terminal Pin

Connector build in PSU	Mated Housing	Mated Terminal Pin	Manufacturer
B2B-XH-A (CN51)	XHP-2 (CN51)	SXH-002T-P0.6 (CN51)	JST
S12B-PHDSS (CN52)	PHDR-12VS (CN52)	SPHD-002T-P0.5 (CN52)	JST

Hand Crimping Tool: YRS-480(SXH-002T-P0.6) (CN51) (JST) and YRS-620(SPHD-002T-P0.5) (CN52)(JST)  
 Use maker recommended crimping tool.

### 3. Connection Method

Please pay attention to the input wiring. If it is connected to wrong terminal, the power supply will be damaged.

- Input must be off when making connections.
- Connect  $\perp$  terminal to earth (frame ground of the equipment etc.) by thick wire for safety and improvement of noise sensitivity.
- The output load line and input line shall be separated to improve noise sensitivity.
- Remote sensing lines shall be twisted or used shielded wires.
- Remote ON/OFF control lines shall be twisted or used shielded wires.
- Output current of each terminal pin of CUS350M Series must be less than 20A.



Recommended torque: M3 screw 0.49N • m (5.0kgf • cm)

### 4. Explanation of Function and Precautions

#### 4-1. Input Voltage Range

Input voltage range is single phase 85-265VAC (47-63Hz). Input voltage, which is out of specification, might lead unit damage. For cases where conformance to various safety requirements, described as 100-240VAC (50-60Hz). If input voltage is less than 115VAC under convection cooling condition or 100VAC under forced air cooling condition, output power need to be derated.

**Derating curve of the input voltage**

**OUTPUT DERATING VERSUS INPUT VOLTAGE**

INPUT VOLTAGE (VAC)	LOAD (%)	
	Convection cooling	Forced air cooling
85	80	90
115~265	100	100

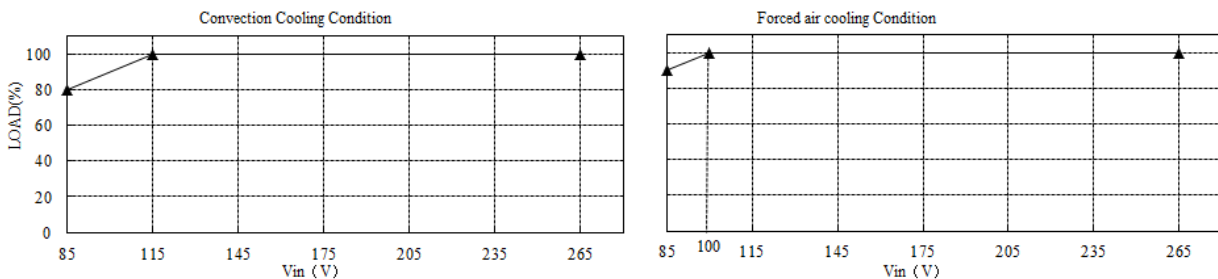

#### 4-2. Output Voltage Range

Output voltage is set at nominal value at shipment. V.adj trimmer (V.adj) can adjust the output voltage within the range. Output voltage range

is within  $\pm 5\%$  of nominal output voltage. Turn the trimmer clockwise, the output voltage will be increased. Take note when the output voltage is increased excessively, over voltage protection (OVP) function may trigger and output will be shut down. Furthermore, when increasing the output voltage reduce the output current so as not to exceed the maximum output power.

### 4-3. Inrush Current

These products equipped Power Thermistor to limit the inrush current. Higher inrush current will flow at higher ambient temperature or re-input condition. Please select input switch and fuse carefully with the high temperature and re-input the power condition. The Inrush Current value is under cold start at 25°C in the specification.

### 4-4. Over Voltage Protection (OVP)

The OVP function (PSU shut down method, manual reset type) is provided. Please refer to its specification for OVP operating range. When OVP trigger, the output will be shut down. To reset OVP, remove the input of power supply for few minutes, and then re-input. In addition, the setting value of OVP is fixed and not adjustable. Pay attention not to apply higher voltage externally to the output terminal to avoid unit failure. In case of inductive load, put protective diode in series to the output power line.

Two methods to recovery from OVP:

- Turn off the input of power supply for a few minutes, and then turn on.
- Remote OFF, and then remote ON again.(Refer to 4-8)

### 4-5. Over Current Protection (OCP)

CUS350M Series provide the hiccup mode with automatic recovery. OCP function operates when the output current exceeds 105% of maximum DC output current of specification. The output will be automatically recovered when the overload condition is removed. Never operate the unit under over current or shorted conditions for more than 30seconds, which may lead damage or failure. OCP setting is fixed and not to be adjusted externally.

### 4-6. Over Temperature Protection (OTP)

The OTP function (manual reset type) is provided. When ambient or internal temperature rises abnormally, OTP function operates and output will be shut down. After shut down, remove the input and cool it down to reset OTP, and then re-input.

### 4-7. Power Good (ALM)

Power Good is an opto coupler providing a minimum 5ms warning before loss of output voltage since AC fail (available only with /F, /PG models). The signal is fully isolated and the maximum sink current 2mA, maximum voltage 20V.

Examples of connecting Power Good are shown as below.

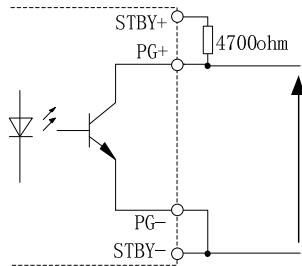

Standard Logic 0

Transistor On (<0.8V) : Power good (DC output is good)  
 Transistor Off (>4.5V): Power not good (AC or DC is not good)

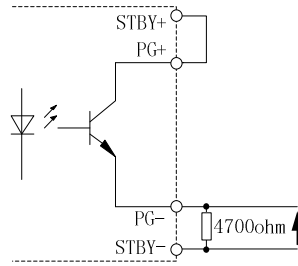

Standard Logic 1

Transistor On (>4.5V) : Power good (DC output is good)  
 Transistor Off (<0.8V): Power not good (AC or DC is not good)

Actual Test Waveform:

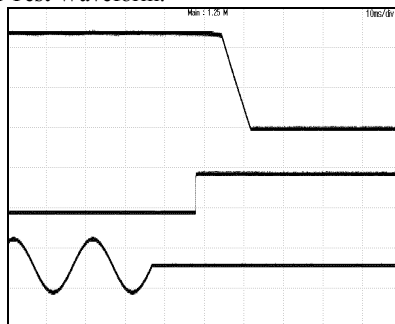

← Vo →  
 ← V<sub>PG+</sub> →  
 ← Vin →

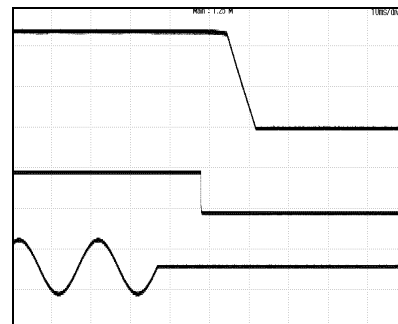

### 4-8. Remote ON/OFF Control

Remote ON/OFF control is an isolated control signal input which turns the power supply off by supplying 5mA to 10mA into the pin. Remote ON/OFF control enable option available, see the below configuration.

- 1) The current limit resistor need be available when the supply voltage is higher than 5V.
- 2) A switch, relay or a transistor, can be used as ON/OFF switch.



Examples of connecting remote ON/OFF control application:.



Actual Test Waveform (limit resistor is 0ohm) :

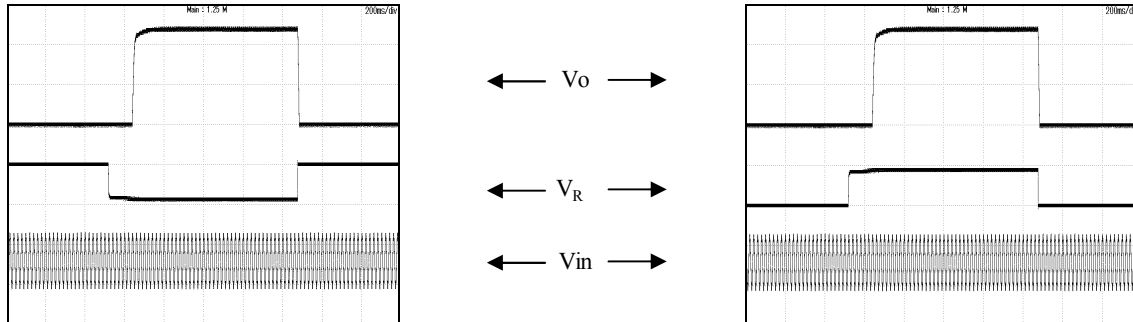

#### 4-9. Remote Sensing (S+, S- terminal)

This function compensates voltage drop of wiring from output terminals to load terminals. Connect “S+” terminal to “+” terminal of load and “S-” to “-” terminal of load with sensing wires. The total line voltage drop (+ side line and – side line) shall be less than 0.5V. Otherwise the output voltage will decrease as the line voltage drop increased. In case that sensing lines are too long, it is necessary to put an electrolytic capacitor in following places.

- 1) Across the load terminal;
- 2) Between “S+” terminal and “V+” terminal;
- 3) Between “S-” terminal and “V-” terminal.

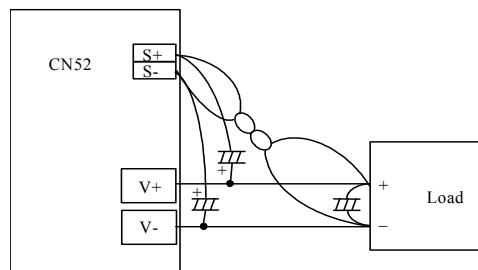

#### 4-10. Output Ripple and Noise

Ripple and noise are measured at 100MHz by using a 150mm twisted pair terminated with a 0.1uF & 100uF capacitor. When load cables are longer, ripple will becomes larger. In this case, electrolytic capacitor, film capacitor, etc. might be necessary to use across the load terminal. The output ripple cannot be measured accurately if the probe ground lead of oscilloscope is too long. For start up at low ambient temperature, output ripple noise might not meet specification. However, output ripple noise specification can be met after few seconds.

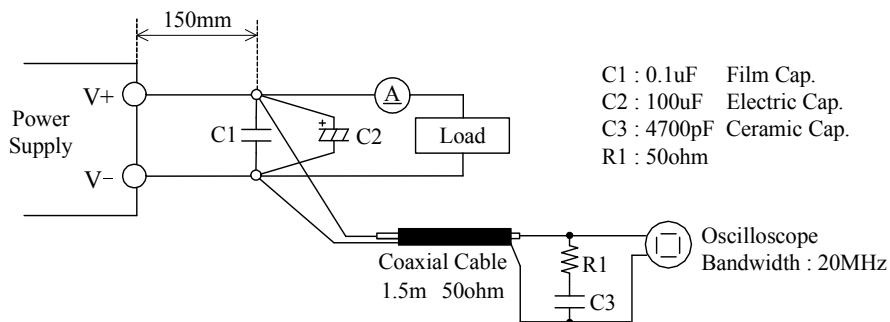

#### 4-7. Series Operation

For series operation, either method (A) or (B) is possible.

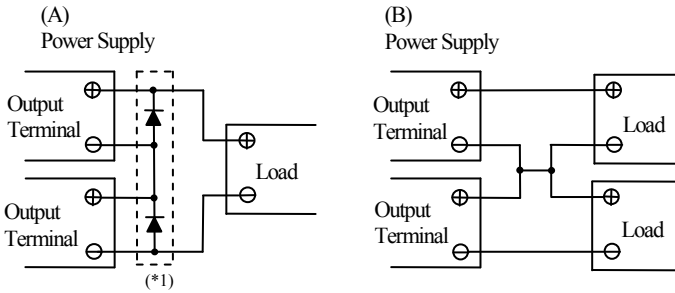

(\*1) Please select a bypass diode with maximum forward current rating more than output load current. And maximum reverse voltage must withstand each power supply output voltage.

#### 4-8. Parallel Operation

No current balance function, not recommend.

#### 4-9. Isolation Test

Isolation resistance between Output – FG is more than 100MΩ at 500VDC. For safety operation, voltage setting of DC isolation tester must be done before the test. Ensure that the unit is fully discharged after the test.

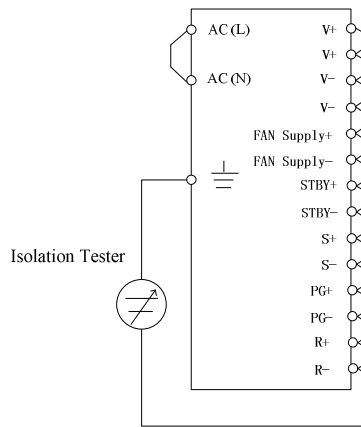

#### 4-10. Withstand Voltage

This series is designed to withstand 4.0kVAC between input and output, 1.5kVAC between input and  $\text{FG}$  and 1.5kVAC between output and  $\text{FG}$  each for 1 minute. When testing withstands voltage, set current limit of the withstand voltage test equipment to 20mA. The applied voltage must be gradually increased from zero to the testing value and then gradually decreased for shut down. When timer is used, the power supply may be damaged by high impulse voltage at timer switch on and off. Connect input and output as follows.

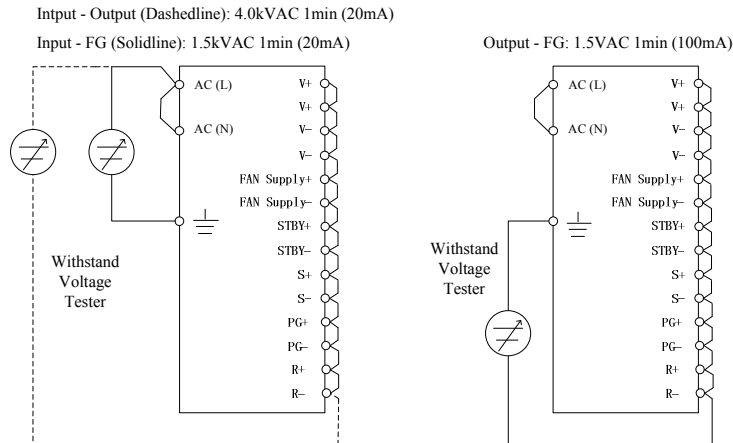

#### 4-11. Auxiliary Supply

Auxiliary supplies - FAN Supply (available only with option models) : 12V/0.3A, Standby Mode Power: 5V/0.5A, are provided to ease customer application. FAN Supply 12V can be used to drive customer system fan. Standby Mode Power 5V can be used as customer system

power supply. Standby Mode Power is always available as long as input power is present. The Fan supply (optional) is controlled by Remote ON/OFF control.

## 5. Mounting Directions

### 5-1. Output Derating according to the Mounting Directions

Recommended standard mounting method is (A), Method (B, C, D, E) are also possible. Refer to the output derating below.

Load (%) of derating curve indicates output power. The E-cap life under Method D and Method E maybe be shorter than 3years, the detail please see the official data.

(A) Standard mounting

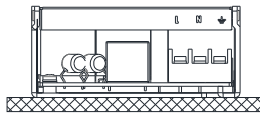

(B)

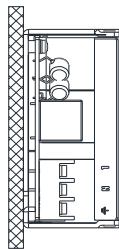

(C)

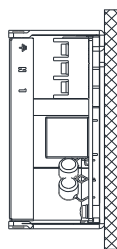

(D)

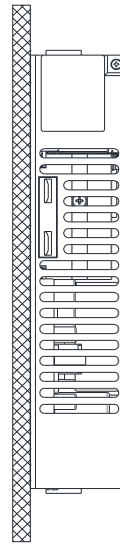

(E)

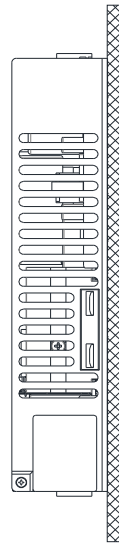

Inhibit

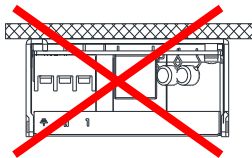

### 5-2. Output Derating vs. Ambient temperature

Make sure that the specified temperature range is maintained.

Ta (°C)	LOAD (%) Convection cooling	LOAD (%) Forced air cooling
-20 - +40	100	100
50	83	100
60	67	75
70	50	50

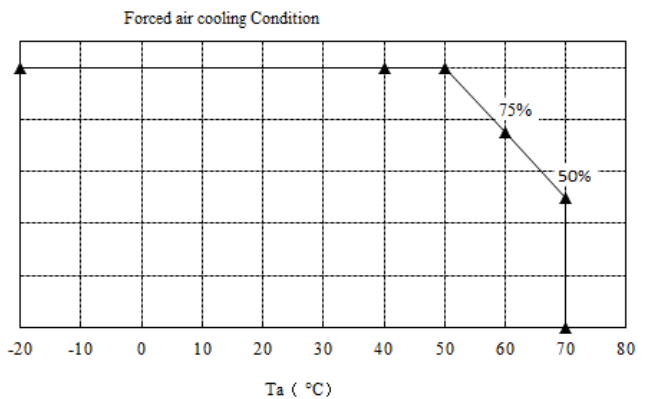
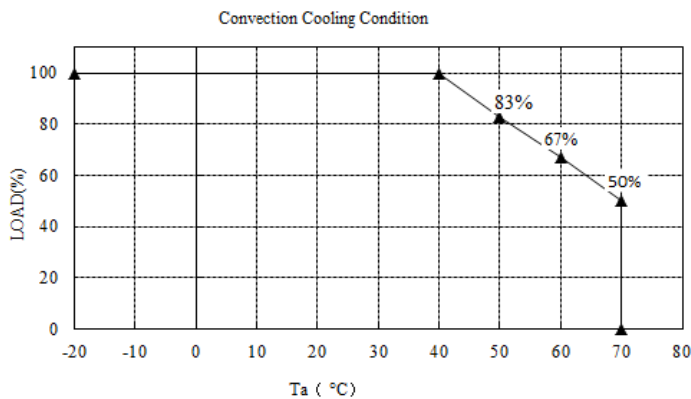

**Forced air cooling condition:**

Minimum air velocity: 1.5m/s (Measured at components side of PCB, air must flow through component side)

**5-4. Mounting Method**

- (1) The maximum allowable penetration for screw into chassis is 4mm.
- (2) Recommended torque for mounting screw: M4 screw, 1.27N·m (13kgf·cm).
- (3) Metal plate with minimum 1.5mm thickness is recommended as mounting plate.
- (4) Keep enough space in the power supply surroundings and the upper area of component for convection cooling, as a reference for reliable thermal design, keep the temperature of Heat Sink lower than 110 °C at Test Point below. the safety space requirement please refer to the related standard..

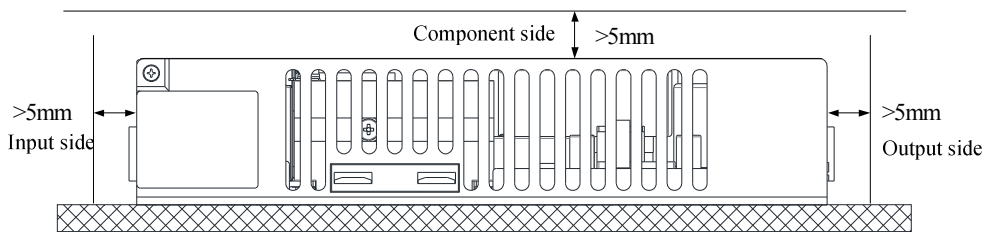

- (5) Rear mounting from bottom side with 4\*M4 screws is recommended to comply the vibration and shock specification. Recommended torque for the Mounting screw: M4 screws, 1.27N·m (13.0kgf·cm).
- (6) Recommend to connect mounting hole to protective ground of system

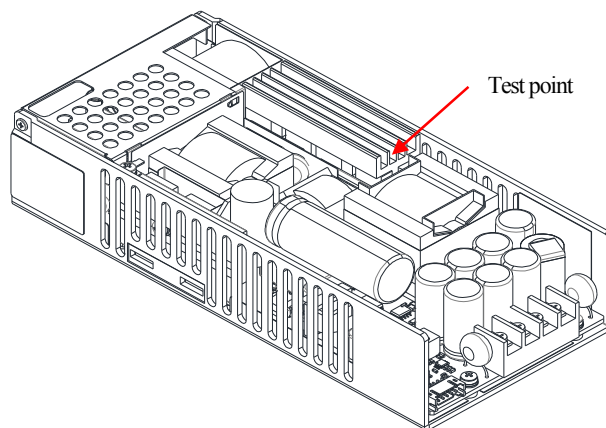

**6. Wiring Method**

- (1) The output and input cables shall be separated each other and twisted individually to improve noise sensitivity.
- (2) Use all cables as thick and short as possible to made lower impedance.
- (3) Noise can be reduced by attaching a capacitor to the load terminals.
- (4) For safety and EMI considerations, connect between  $\varnothing$  terminal of input connector and Protective Earth terminal of equipment firmly.
- (5) Recommended torque for the terminal: M3 screw, 0.49N·m (5.0kgf·cm).

**7. External Fuse Rating**

Refer to the following fuse rating when selecting the external fuses that are to be used on input line. Surge current flows when line turns on. Have to use slow-blow or time-lag type fuse, not fast-blow fuse. Fuse rating is considered by in-rush current value at line turn-on. Do not select the fuse according to input current (RMS.) values under the actual load condition.

CUS350M Series: 6.3A

## **8. Before concluding that the unit is at fault**

- (1) Check if the rated input voltage is connected.
- (2) Check if the wiring of input and output is correct.
- (3) Check if the wire thickness is enough.
- (4) Check if the output current and output wattage dose not over specification.
- (5) Check if the output voltage control ( $V_{adj}$ ) is properly adjusted. OVP might be triggered and output is shut down.
- (6) Check if the Remote ON/OFF control circuit is connected correctly.
- (7) Check if OTP is triggered. Please re-input to cool down the unit sufficiently.
- (8) Audible noise can be heard when input voltage waveform is not sinusoidal wave.
- (9) Audible noise can be heard during Dynamic-Load operation.

## **9. Altitude**

CUS350M is safety approved for operation at below altitude.

-Up to 5000m by IEC60950-1 clearance requirement.

-Up to 4000m by IEC60601-1 clearance requirement.

Thermal evaluation should be considered for products operating at elevated altitudes above 2000m.