

EFE300 / EFE400
EFE300M / EFE400M

AC/DC Power Supply Series

APPLICATION NOTE

1. INPUT	3
AC INPUT LINE REQUIREMENTS	3
2. DC OUTPUT	3
OUTPUT VOLTAGES	3
REMOTE SENSE	3
EFFICIENCY	3
NO LOAD OPERATION	3
CAPACITIVE LOAD OPERATION	4
SERIES/PARALLEL CONNECTION	4
OUTPUT CHARACTERISTICS	4
Ripple/Noise	4
POWER SUPPLY TIMING	5
SIGNALS – EFE300M and EFE400M only	6
POWER GOOD SIGNAL	6
REMOTE ON/OFF – GLOBAL ON/OFF	6
OVERSHOOT AT TURN ON/OFF	7
OUTPUT PROTECTION	7
COOLING REQUIREMENTS	7
TEMPERATURE DERATING	8
RELIABILITY	8
ELECTROMAGNETIC COMPATIBILITY	9
Installation for optimum EMC performance	9
ESD Protection	9
3. CONNECTION	11
AC Input Connector (J1)	11
AC Input Connector (J1) Pin Definition (All units)	11
Output (J2)	11
Output Connector (J2) Pin Definition EFE300	11
Output Connector (J2) Pin Definition EFE300M	11
Output Connector (J2) Definition EFE400	12
Output Connector (J2) Definition EFE400M	12
Fan supply	12
4. MOUNTING	12
5. WEIGHTS	13
6. TEST RESULTS	13

1. INPUT

AC INPUT LINE REQUIREMENTS

See datasheet for specification of input line requirements (including Input voltage range, Input frequency, Input harmonics, Input current and leakage current)

The power supply will automatically recover from AC power loss and shall be capable of start-up under peak loading at 90VAC.

Repetitive ON/OFF cycling of the AC input voltage shall not damage the power supply or cause the input fuse to blow.

- Input Fuse
Not user serviceable. Fast Acting, high breaking capacity, ceramic fuse.
- Input Undervoltage
The power supply is protected against the application of an input voltage below the minimum specified so that it shall not cause damage to the power supply.

2. DC OUTPUT

OUTPUT VOLTAGES

All output channels except the fan supply are isolated from each other. The fan supply shares a common 0V with channel 1. The outputs cannot be adjusted once the product has left the factory. This ensures that the unit remains set as required and prevents field failures of connected equipment caused by users adjusting the output voltage outside the required range. See the datasheet for full specifications of the output, including setting range, output current, regulation, ripple & noise and setting accuracy.

REMOTE SENSE

Remote sensing is not provided as this is not normally necessary on output voltages of 12V and above.

EFFICIENCY

Note that the following charts show the efficiency of the main output channel. The efficiency chart will be slightly different if the Standby and fan supplies are used.

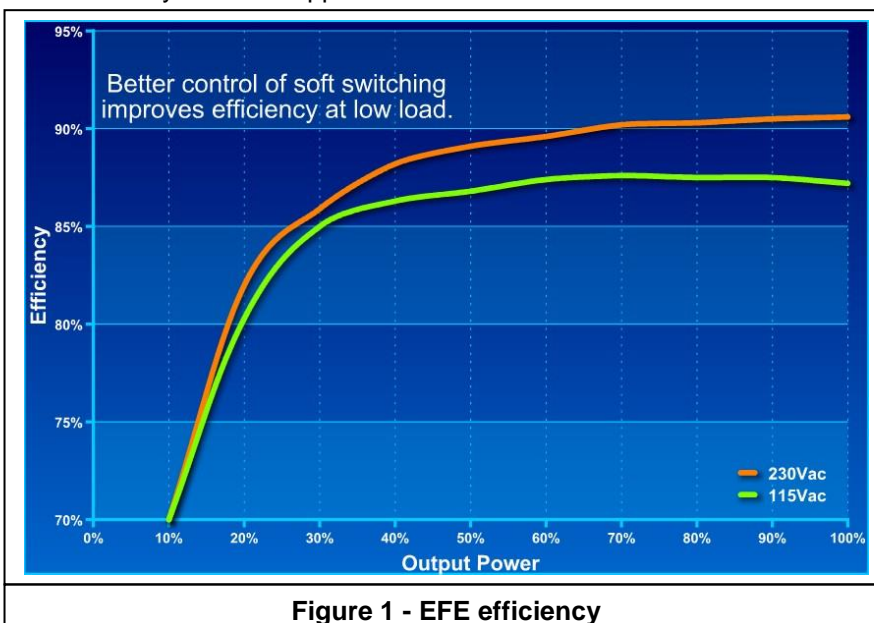

NO LOAD OPERATION

No minimum load is required for the power supply to operate within specification.

CAPACITIVE LOAD OPERATION

Maximum capacitance is 1000 μ F/A for 12 and 24V models, 500 μ F/A for 28V, and 250 μ F/A for higher voltages. For example EFE400-12 will supply 33.3A continuously so will operate correctly with up to 33300 μ F of capacitance connected to the output.

SERIES CONNECTION

Please contact Technical sales for guidance

PARALLEL CONNECTION

For EFE300/EFE400

Outputs must not be connected in parallel unless ORing diodes are used. This configuration can then be used to provide redundant operation. Do not connect more than 2 power supplies in parallel.

For EFE300M/EFE400M

Internal to the unit, there is an ORing FET which enables parallel connection without the need for additional, external ORing diodes. An ORing diode has a typical volt drop of 0.4-0.5 volts, for the EFE300M-12 this would result in a power loss in excess of 10 watts (at 25A) being dissipated into a heatsink fixed to the diode. The ORing FET scheme has a RDS on of typically 4-5mOhms, this results in a power dissipation of 2.5 watts.

It is possible to request units with current sharing provided by droop method. This relaxes the load regulation specification to provide improved sharing between parallel connected power supplies. Please contact technical sales for details.

OUTPUT CHARACTERISTICS

Ripple/Noise

Ripple and noise is defined as periodic or random signals over a frequency range of 10Hz to 20MHz. Measurements are to be made with an 20MHz bandwidth oscilloscope. Measurements are taken at the end of a 150mm length of a twisted pair of cables, terminated with a 100nF ceramic capacitor and a 120 μ F electrolytic capacitor. The earth wire of the oscilloscope probe should be as short as possible, winding a link wire around the earth collar of the probe is the preferred method.

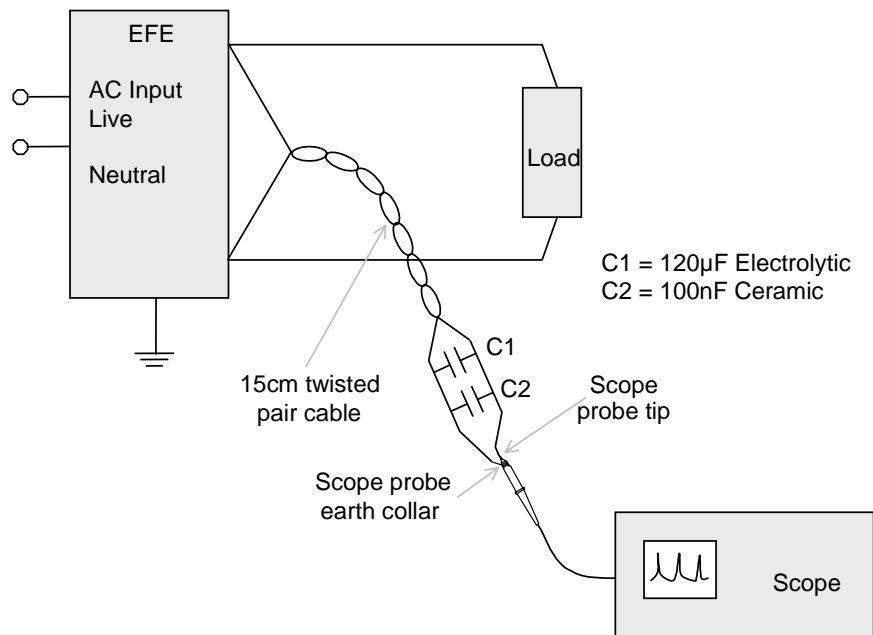

Figure 2 – Ripple and Noise measurement method

POWER SUPPLY TIMING

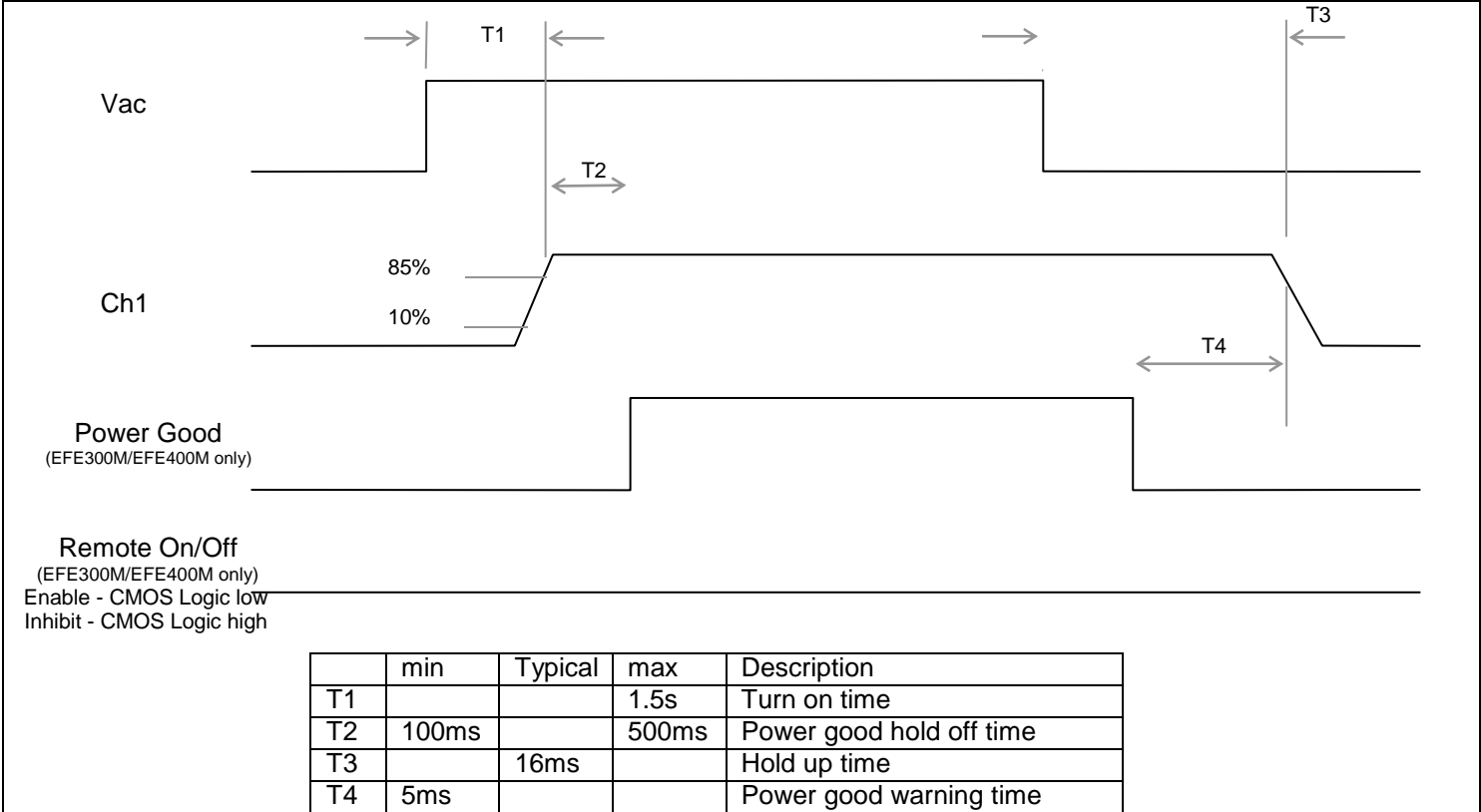

Figure 3 - Output timing diagram

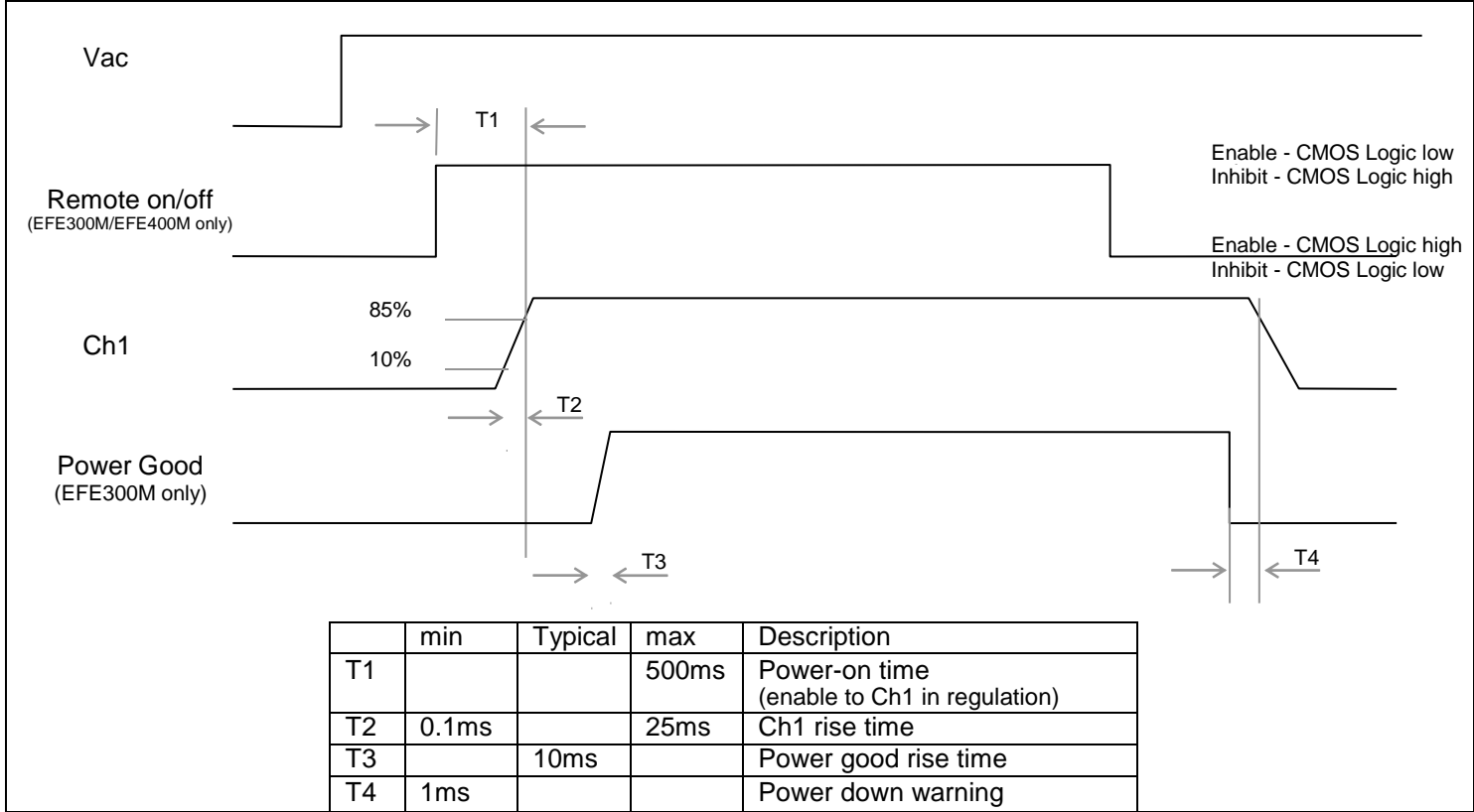

Figure 4 - Output timing diagram (EFE300M and EFE400M only)

SIGNALS – EFE300M and EFE400M only

STANDBY SUPPLY

An output that is isolated from the other output channels. It is not affected by the remote on/off. 5V / 2A and 12V / 1A versions are available (selectable at time of ordering)

POWER GOOD SIGNAL

The Power Good signal is a TTL level signal. Logic high indicates ac supply is good and Channel 1 is within regulation. It is delayed after start-up to ensure that sufficient primary side energy is stored by the power supply for continuous power operation within the specified hold-up time. When the AC power is removed the Power Good Signal will go to a logic low. The specifications for the Power Good Signal are contained below

Signal Type	TTL referenced to 0V of standby supply
Source Current	1mA
Sink Current	5mA

REMOTE ON/OFF – GLOBAL ON/OFF

Do not connect if Remote On/Off type 'N' (none) is fitted.

Control is fitted with an internal pull up resistor to 5V so no connection = logic high.

Maximum input voltage – 5V

Maximum current required for Logic High – 1mA

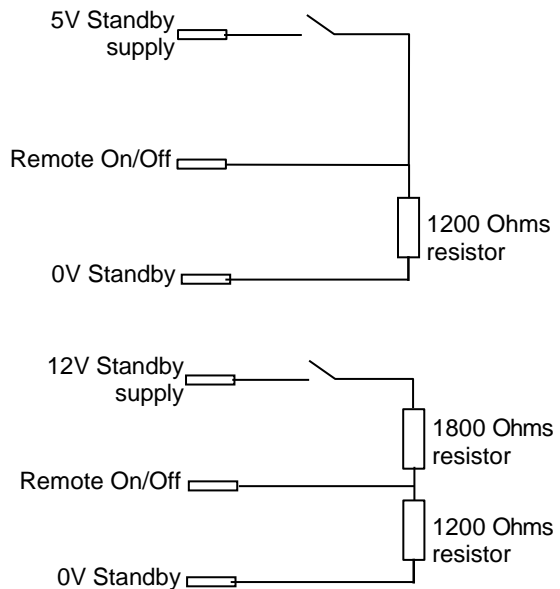

Switch State	Remote on/off type	
	Enable (E)	Inhibit (T)
Open	On	Off
Closed	Off	On

'On' indicates power supply operating.
'Off' indicates channel 1 and fan supply not operating. Standby continues to operate

Figure 5: Example uses of 'Remote On/Off'

OVERSHOOT AT TURN ON/OFF

The output voltage overshoot upon the application or removal of the input mains voltage shall be less than 10% above the nominal voltage. No voltage of opposite polarity shall be present on any output during turn on or turn off.

OUTPUT PROTECTION

No Load Operation

The power supply will operate with no load on all outputs with no damage, hazardous condition or reduction in performance.

Overload Protection

The power supply will operate for up to 10 seconds at the peak output power specified on the datasheet. After this time, the power supply will shut down for approximately 60 seconds before resuming output. To prevent this shut down, remove the overload condition

Over current protection

If a load is applied which takes the power supply into over current then the power supply will enter a hiccup state. This will turn the output on for approximately 50ms then off for approximately 1 second. This state will continue until the over current is removed.

Short-Circuit Protection

A short circuit is defined as an impedance of <0.1 Ohms placed between the DC return and any output. A short circuit will cause no damage to the power supply and will cause it to shutdown. The power supply will attempt to restart until the short-circuit is removed. After removal of the short circuit, the power supply will maintain normal operation.

Over temperature protection

If the EFE is operated without adequate cooling, it will cause an over temperature condition and the power supply will either shut down or enter a thermal hiccup mode of operation. To correct this, improve the cooling of the power supply, remove the ac supply for 10 seconds and then reapply.

Over voltage protection

An overvoltage on CH1 will cause the whole power supply to shutdown. To restart the PSU, remove the ac supply for 10 seconds and then reapply.

COOLING REQUIREMENTS

Forced Air Cooling

The maximum continuous rating of the main channel (Ch1) of the EFE300/EFE300M is 300W and for the EFE400/EFE400M is 400W with a minimum of 2m/s (approximately 10CFM) of forced-air cooling across the power supply. The fan supply (all EFE range) and standby supply (EFE300M/400M only) are in addition to this power. The recommended air flow direction is from input to output.

Fan Noise

These charts show the sound pressure levels of typical units at different temperatures. The sound measurements were taken 1metre away from and directly in line with the fan. Results are 'A' weighted.

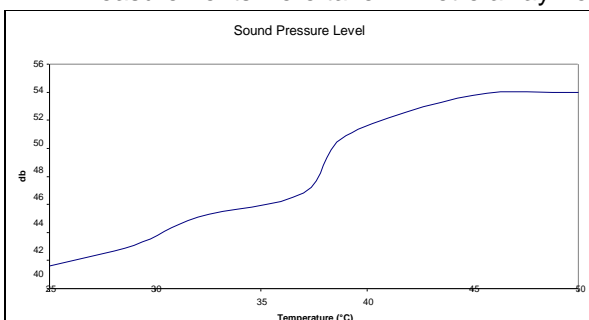

Figure 6 - EFE-300 fan noise

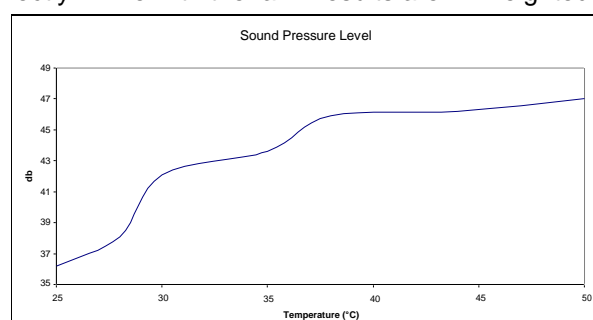

Figure 6 - EFE-300M fan noise

TEMPERATURE DERATING

EFE achieves full power output up to 50°C. Above this temperature, the total output power (and individual output currents) must be derated by 2.5%/°C up to 70°C. See diagram.

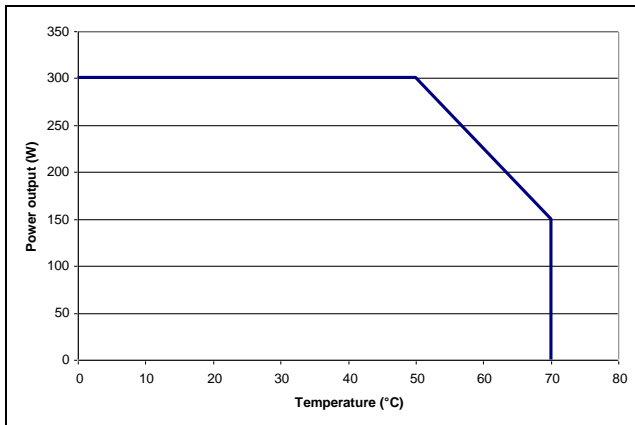

Figure 8 - EFE300 / EFE300M Thermal derating curve

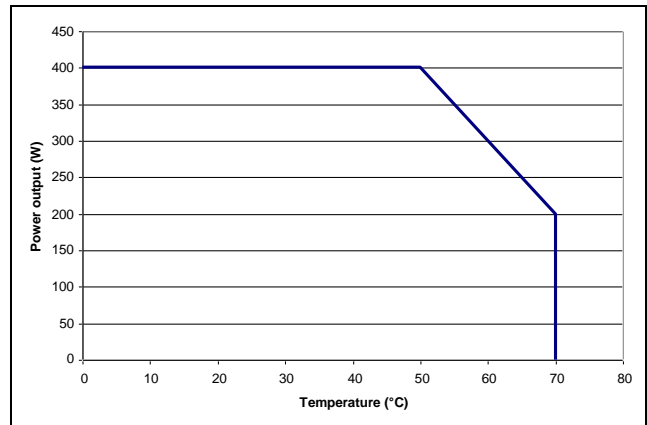

Figure 9 - EFE400 / EFE400M Thermal derating curve

RELIABILITY

Calculated using Telcordia Issue 1, Case 3

FPMH (Failures per million hours)

Temperature	0°C	10°C	20°C	30°C	40°C	50°C	60°C	70°C
EFE300	0.437	0.570	0.750	0.998	1.344	1.834	2.537	3.558
EFE300M	0.636	0.836	1.114	1.509	2.083	2.936	4.227	6.206
EFE400	0.448	0.588	0.777	1.039	1.410	1.956	2.780	4.059
EFE400M	0.847	1.088	1.421	1.895	2.594	5.073	5.289	7.850
Fan	1.199	1.311	1.422	1.534	2.427	3.846	6.054	9.560

To calculate MTBF, sum the FPMH for the component parts at the required temperature. This gives total failures per million hours (FPMH). Convert this to MTBF by dividing 1000000 by the FPMH.

For example: -

Require the MTBF for EFE300 with fan at 20°C

EFE300 0.750 FPMH

Fan 1.422 FPMH

Total FPMH 2.172

Therefore MTBF = 1000000 / 2.172 = 460405 hours (460k hours)

ELECTROMAGNETIC COMPATIBILITY

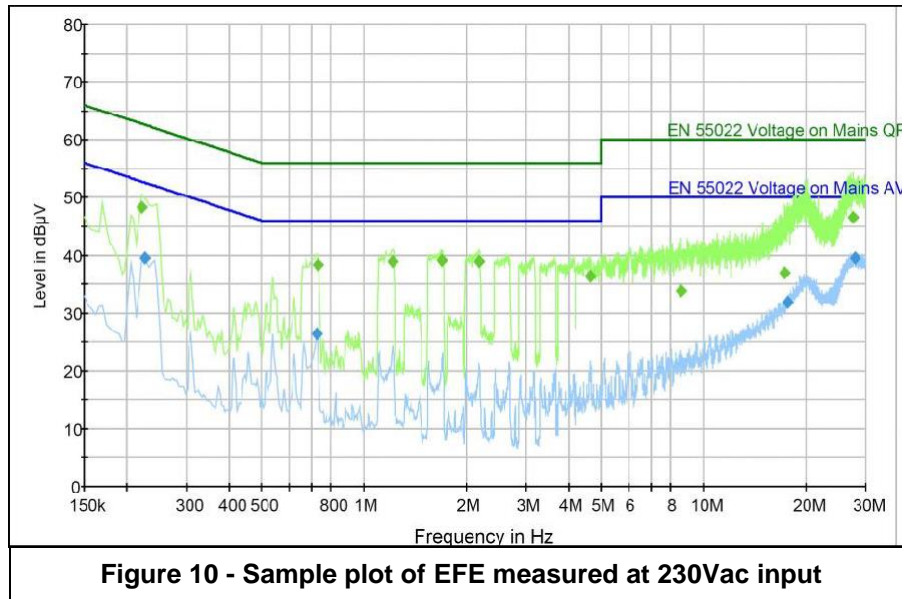

Installation for optimum EMC performance

Mounting

All equipment should be mounted inside an earthed metal box.
 If this is not possible then use an earthed metal plane to mount the power supply and load.
 All 4 corners (of the uncased unit) should be connected to earth.

Cables

All cables (both ac input and dc output) should be run as close as possible to the earthed metal box/plane.
 AC input cable should be a twisted group laid as flat to the earthed metal box/plane as possible.

All output cables should be routed as far away from input cables as possible.
 If the input and output cables must be run close to each other then screen one or other (or ideally both).

The positive and negative supply cables should be twisted together.
 All cable run loops should be kept as small as possible (this should be implemented in PCB design also).

Connecting between boxes

If cables must be connected between equipment boxes then at the closest possible point to the port where the cables exit the 1st enclosure connect 100nF decoupling Y caps (between the output and earth). Note that these capacitors must be rated at the working voltage. Ideally these capacitors should be between all signal cables which have to connect between boxes although this may not be practical if fast switching [digital] signals are involved (if this is the case then smaller value Y capacitors should be used).

Earth star point

Where the ac supply enters the equipment, this should be taken to a 'star point' chassis mounted earth point (Note compliance with EN60950-1 practices which require the main protective earth to have its own dedicated spring washer and nut) as close as possible to the IEC inlet. All other earth points should be taken back to this point only.

ESD Protection

Where signal or control ports are connected to a user accessible panel (for example PSU inhibit to a switch, module good to an indicator circuit, etc), these ports must be protected from electrostatic discharges. This can be done by selecting suitable panel controls or by fitting ESD suppression devices to the connections on the panel.

EFE300M & EFE400M Conducted Emissions with Output Earthed

If the power supply output is connected to earth the conducted emissions measurements can show a peak between 2-15MHz:

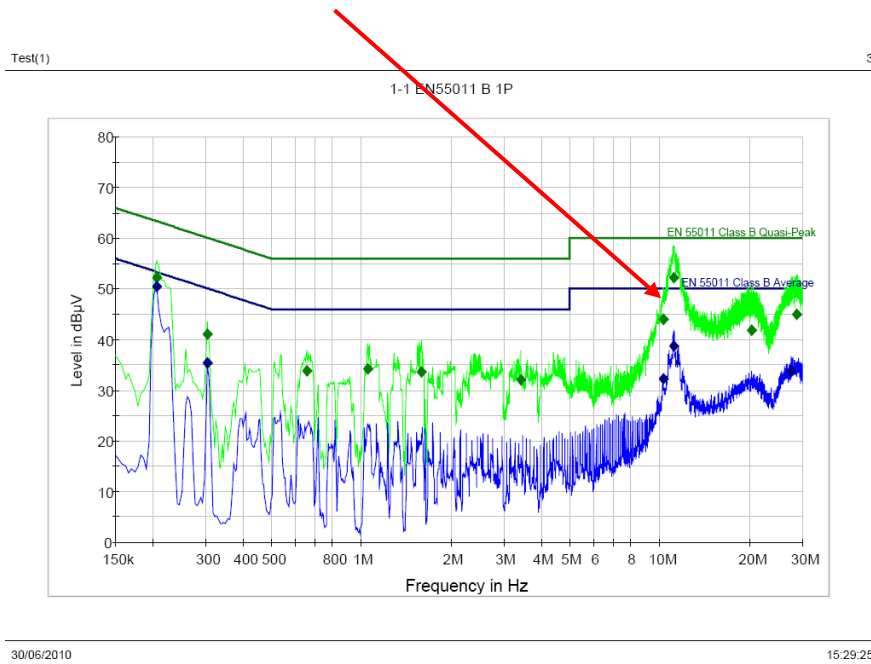

To remove this peak, put a high-perm ferrite core in the lead which connects the output of the power supply to earth. This greatly reduces the resonant frequency and the Q:

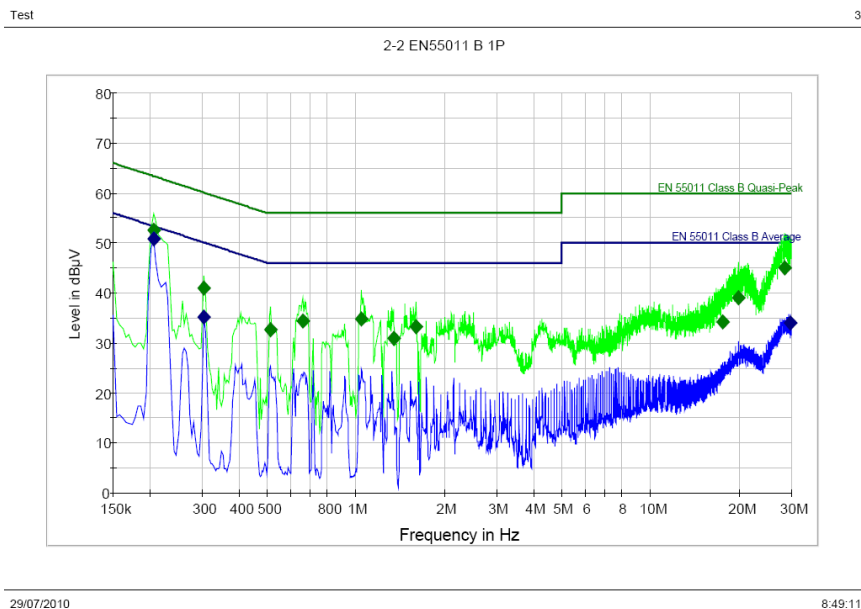

3. CONNECTION

AC Input Connector (J1)

Molex sabre (EFE300M/EFE400M option only)	Molex kk (all units)	
44441-2003	09-50-8051	Molex housing part number
43375-0001	08-52-0113	Molex crimp part number
	94910	TDK-Lambda part number for 1 housing + 3 crimps

AC Input Connector (J1) Pin Definition (All units)

Pin	Pin	Function
J1-3	J1-1	Earth – chassis/safety ground
	J1-2	Do not connect
J1-2	J1-3	Live
	J1-4	Do not connect
J1-1	J1-5	Neutral

Output (J2)

Product	Molex part numbers		Crimps required	TDK-Lambda Kit Part Number (kit includes 1 housing and sufficient crimps for the connector)
	Housing	Crimp		
EFE300	39-01-2105	44476-3112	10	94750
EFE400	39-01-2145	44476-3112	14	94751
EFE300M	39-01-2185	44476-3112	17	94752
EFE400M	39-01-2200	44476-3112	20	94912

Output Connector (J2) Pin Definition EFE300

See datasheet for drawing of output connector.

Standard [right angled/horizontal] connector				Vertical connector			
Bottom row		Top row		Bottom row		Top row	
Pin	Connection	Pin	Connection	Pin	Connection	Pin	Connection
J2-1	+V Ch1	J2-6	0V Ch1	J2-1	0V Ch1	J2-6	+V Ch1
J2-2	+V Ch1	J2-7	0V Ch1	J2-2	0V Ch1	J2-7	+V Ch1
J2-3	+V Ch1	J2-8	0V Ch1	J2-3	0V Ch1	J2-8	+V Ch1
J2-4	+V Ch1	J2-9	0V Ch1	J2-4	0V Ch1	J2-9	+V Ch1
J2-5	+V Ch1	J2-10	0V Ch1	J2-5	0V Ch1	J2-10	+V Ch1

Output Connector (J2) Pin Definition EFE300M

See datasheet for drawing of output connector.

Standard [right angled/horizontal] connector				Vertical connector			
Bottom row		Top row		Bottom row		Top row	
Pin	Connection	Pin	Connection	Pin	Connection	Pin	Connection
J2-1	+V Standby	J2-10	0V standby	J2-1	+12V Fan	J2-10	Do not connect
J2-2	Remote on/off	J2-11	Power Good	J2-2	0V Ch1	J2-11	+V Ch1
J2-3	+V Ch1	J2-12	0V Ch1	J2-3	0V Ch1	J2-12	+V Ch1
J2-4	+V Ch1	J2-13	0V Ch1	J2-4	0V Ch1	J2-13	+V Ch1
J2-5	+V Ch1	J2-14	0V Ch1	J2-5	0V Ch1	J2-14	+V Ch1
J2-6	+V Ch1	J2-15	0V Ch1	J2-6	0V Ch1	J2-15	+V Ch1
J2-7	+V Ch1	J2-16	0V Ch1	J2-7	0V Ch1	J2-16	+V Ch1
J2-8	+V Ch1	J2-17	0V Ch1	J2-8	Power Good	J2-17	Remote on/off
J2-9	Do not connect	J2-18	+12V Fan	J2-9	0V standby	J2-18	+V Standby

Output Connector (J2) Definition EFE400

See datasheet for drawing of output connector.

<i>Standard [right angled/horizontal] connector</i>				<i>Vertical connector</i>			
Bottom row		Top row		Bottom row		Top row	
Pin	Connection	Pin	Connection	Pin	Connection	Pin	Connection
J2-1	+V Ch1	J2-8	0V Ch1	J2-1	0V Ch1	J2-8	+V Ch1
J2-2	+V Ch1	J2-9	0V Ch1	J2-2	0V Ch1	J2-9	+V Ch1
J2-3	+V Ch1	J2-10	0V Ch1	J2-3	0V Ch1	J2-10	+V Ch1
J2-4	+V Ch1	J2-11	0V Ch1	J2-4	0V Ch1	J2-11	+V Ch1
J2-5	+V Ch1	J2-12	0V Ch1	J2-5	0V Ch1	J2-12	+V Ch1
J2-6	+V Ch1	J2-13	0V Ch1	J2-6	0V Ch1	J2-13	+V Ch1
J2-7	+V Ch1	J2-14	0V Ch1	J2-7	0V Ch1	J2-14	+V Ch1

Output Connector (J2) Definition EFE400M

See datasheet for drawing of output connector.

<i>Standard [right angled/horizontal] connector</i>				<i>Vertical connector</i>			
Bottom row		Top row		Bottom row		Top row	
Pin	Connection	Pin	Connection	Pin	Connection	Pin	Connection
J2-1	+V Standby	J2-11	0V standby	J2-1	+12V Fan	J2-11	+V Ch1
J2-2	Remote on/off	J2-12	Power Good	J2-2	0V Ch1	J2-12	+V Ch1
J2-3	+V Ch1	J2-13	0V Ch1	J2-3	0V Ch1	J2-13	+V Ch1
J2-4	+V Ch1	J2-14	0V Ch1	J2-4	0V Ch1	J2-14	+V Ch1
J2-5	+V Ch1	J2-15	0V Ch1	J2-5	0V Ch1	J2-15	+V Ch1
J2-6	+V Ch1	J2-16	0V Ch1	J2-6	0V Ch1	J2-16	+V Ch1
J2-7	+V Ch1	J2-17	0V Ch1	J2-7	0V Ch1	J2-17	+V Ch1
J2-8	+V Ch1	J2-18	0V Ch1	J2-8	0V Ch1	J2-18	+V Ch1
J2-9	+V Ch1	J2-19	0V Ch1	J2-9	Power Good	J2-19	Remote on/off
J2-10	+V Ch1	J2-20	+12V Fan	J2-10	0V standby	J2-20	+V Standby

Fan supply

The type of fan supply available is determined by the Case/Fan Option.

EFE300 and EFE400 (J3)

-CC and -EC have no customer accessible fan supply.

-CN and -CU are supplied with 12V / 250mA fan supply. The fan supply is available on J3.

the Fan Supply housing is part number 02201-3037 (or equivalent part from alternative manufacturer), the Molex part number for the crimps is 08-50-0032 (or equivalent part from alternative manufacturer).

Pin 3 should not be connected (it is only used if the factory fitted variable speed fan is fitted)

Pin	Function
J3-1	Fan supply 0V
J3-2	Fan supply 12V
J3-3	Do not connect

EFE300M and EFE400M (J2)

-HN, -HU and -HC are supplied with 12V / 1A fan supply. Fan supply available on output connector (J2).

-CN, -CU and -CC are supplied with 12V / 250mA fan supply. Fan supply available on output connector (J2).

-EC, -NC, -NU and -NN have no customer accessible fan supply.

4. MOUNTING

EFE-300, EFE-400, EFE300M and EFE400M must be mounted on all four corners. Please refer to handbook for allowable orientations.

'-CU' or '-HU' (U chassis, no fan), '-CC' or '-HC' (cover + chassis, no fan) and '-EC' (cover + chassis, end fan) versions to be mounted using all four fixings on the bottom of the unit or the fixing holes on the side of the unit. Uncovered versions should be mounted on stand-offs that are at least 6.4mm tall. Note, the stand-off requirement may be reduced if an insulator is installed between the bottom of the unit and the chassis.

5. WEIGHTS

Unit	Unit	Weight (g) typ
EFE-300	open frame	310
EFE-300	U Chassis	400
EFE-300	cover + Chassis + end fan	550
EFE-400	open frame	430
EFE-400	U Chassis	540
EFE-400	cover + Chassis + end fan	650
EFE-300M	open frame	350
EFE-300M	U Chassis	450
EFE-300M	cover + Chassis + end fan	600
EFE-400M	Open frame	450
EFE-400M	U Chassis	575
EFE-400M	cover + Chassis	640
EFE-400M	cover + Chassis + end fan	700

6. TEST RESULTS

Detailed test results are available online from: -

<http://testcert.emea.tdk-lambda.com/>

You will need the serial number and product code of the unit to retrieve the test results for the unit. Test results are not packaged with the unit. This ensures that the test results will be available for the EFE unit for the whole life of the power supply (not just when the unit is unpacked as with the more traditional printed test results).