

1000W to 1500W Single Output Medical Power Supplies

<https://product.tdk.com/en/power/rws-b>
www.emea.lambda.tdk.com/rws-b



Medical



The RWS1000/1500-B/ME are 1000W and 1500W rated AC-DC medical power supplies, designed to provide solid performance at an economical price. The series accepts a wide range 85 to 265Vac input with output voltages from 12V to 48V. These 7-year warranty products are certified to the IEC60601-1 safety and IEC60601-1-2 Ed.4 immunity standards. The output to ground isolation (1x MOPP) is 1,500Vac, making the power supplies suitable for B and BF rated equipment.

Features	Benefits
• Seven Year Warranty	• Low Cost of Ownership
• Conservative Electrolytic Capacitor Ratings	• Long Service Life
• Class A Conducted and Radiated EMI	• Easier System EMC Compliance
• Configurable Output Screw Terminal Block Orientation	• Simplified Cable Connections
• Medical Certifications (2 x MOPP)	• Suitable for B & BF Rated Equipment

Model Selector								
Model	Voltage (V)	Adjustable Range (V)	Max Current (A)	Max Output Power (W)	Load Reg (mV)	Line Reg (mV)	Ripple Noise (mV)	Efficiency (typ) % 115/230 Vac
RWS1000B-12/ME	12V	10.2-13.8V	84	1008	96	48	150	82 / 85
RWS1500B-12/ME	12V	10.2-14.4V	125	1500	96	48	150	81 / 85
RWS1000B-15/ME	15V	12.8-17.2V	67	1005	120	60	150	82 / 85
RWS1500B-15/ME	15V	12.8-18.0V	100	1500	120	60	150	82 / 85
RWS1000B-24/ME	24V	20.4-28.8V	42	1008	144	96	180	85 / 88
RWS1500B-24/ME	24V	20.4-28.8V	63	1512	144	96	180	85 / 88
RWS1000B-36/ME	36V	30.6-41.4V	28	1008	216	144	250	85 / 88
RWS1500B-36/ME	36V	30.6-43.2V	42	1512	216	144	250	85 / 88
RWS1000B-48/ME	48V	40.8-52.8V	21	1008	288	192	300	85 / 88
RWS1500B-48/ME	48V	40.8-52.8V	32	1536	288	192	300	85 / 88

RWS1000B-	12	/	ME
	Output voltage 12, 15, 24, 36, 48		Medical

Option combinations are available, please contact your local sales office.

Specifications		
Model		RWS1000/1500-B/ME
Input		
AC Input Voltage Range (1)	Vac	85 - 265
DC Input Voltage range*	Vdc	120 - 340*
AC Input Frequency	Hz	47 - 63
Input Current (110/230Vac)	A	RWS1000B: 13 / 7, RWS1500B: 19 / 10
Inrush Current at 100/200Vac (Cold Start)	A	60 / 60
Leakage Current	mA	< 1.2
Power Factor (10/200Vac)	-	0.98 / 0.95
Harmonic Compliance	-	Meets IEC61000-3-2
Hold Up Time	ms	20
Efficiency	-	See model selector table
Conducted & Radiated EMI	-	EN55011/EN55032-A, FCC Class A, VCCI-A
Immunity	-	See immunity table
Safety Certifications and Markings	-	IEC/ES/CSA/EN60601-1, CE Mark and UKCA Mark

Immunity				
Test	Standard	Test Level	Criteria	Notes: See IEC61000 immunity test report on website for further details
ESD	EN61000-4-2	Air ± 8kV and contact ± 4kV	B	
Radiated Susceptibility	EN61000-4-3	80M -1GHz: 10V/m 1.4 - 2.0GHz: 3V/m 2.0 - 2.7GHz: 1V/m	A	
Electrical Fast Transient Burst	EN61000-4-4	± 2kV	B	
Surge	EN61000-4-5	Normal ± 2kV Common ± 4kV	B	
Conducted Susceptibility	EN61000-4-6	10Vrms	A	
Magnetic Fields	EN61000-4-8	30A/m	A	
Voltage Dips	EN61000-4-11	30% 500ms	B	
		60% 10ms	B	
		100% 20ms	A	
		100% 5000ms	B	
Voltage Dips	EN60601-1-2 Ed.4	30% 500ms	B	
		100% 10ms	A	
		100% 20ms	A	
SEMI F47 Line Dip	SEMI F47	100% 5000ms	B	At input voltages > 200Vac

Specifications		
Model		RWS1000/1500-B/ME
Output		
Switching Frequency	kHz	RWS1000B; 95, RWS1500B; 85, PFC converter 65
Line Regulation	-	See model selector table
Load Regulation	-	See model selector table
External Load Capacitance	uF	100,000
Ripple & Noise	mV	See model selector table
Temperature Coefficient	%/°C	0.02
Minimum Load	-	No minimum load required
Overcurrent Protection	%	≥105. Constant current mode with automatic recovery. A prolonged overload of more than 5s will cause unit to shutdown
Overvoltage Protection	-	Latching (unit shutdown), cycle AC input to reset
Overtemperature Protection	-	Latching (unit shutdown), cycle AC input to reset
Remote Sense	-	Yes
Remote On/Off	-	Contact sales. ON when the external voltage is applied, OFF when open
DC Good / Fan Alarm	-	Contact sales for availability
Standby Voltage	-	Contact sales for availability
Indicators	-	Green LED indicates DC is OK
Parallel Operation	-	Contact sales for availability

Specifications		
Model		RWS1000/1500-B/ME
Environmental		
Operating Temperature	°C	-20 to +60, derate linearly to 60% load from 50 to 60
Operating Humidity	%RH	20 - 90%RH (No Condensing)
Storage Temperature	°C	-30 to +75
Humidity (non condensing)	%RH	10 - 90 (Operating & Storage)
Cooling	-	Forced air
Altitude	m	3000
Withstand Voltage (For 1 minute)	VAC	Input to ground 2,000 (1xMOPPs), Input to output 4,000 (2xMOPPs), Output to ground 1,500 (1xMOPP) for 1 minute
Vibration (Non operating)	-	10-55Hz (Sweep for 1min.) 19.6m/s ² Constant X,Y,Z 1 hour each
Shock (Non operating)	-	Less than 196m/s ² , 11ms, ±X, ±Y, ±Z 3 times each
Other		
Weight (Typ)	g	RWS1000B: 2000, RWS1500B: 3000
Size (WxHxD)	mm	RWS1000B; 127 x 63 x 198, RWS1500B; 127 x 63 x 261
Size (WxHxD)	Inches	RWS1000B; 5 x 2.48 x 7.8, RWS1500B; 5 x 2.48 x 10.28
Connectors	-	Screw terminal input and output. Signal connectors JST S12B-PHDSS
MTBF - Telcordia SR-332 issue 3*	Hours	1,222,361
Warranty	yrs	7

Notes

See website for detailed specifications, test methods and installation manual

(1) Derate linearly to 80% load from 90 to 85Vac input

*Safety certified for AC input only

**RWS1500B-24 model, 25°C ambient, full load, 24Vdc input

Outline Drawing RWS1000B/ME

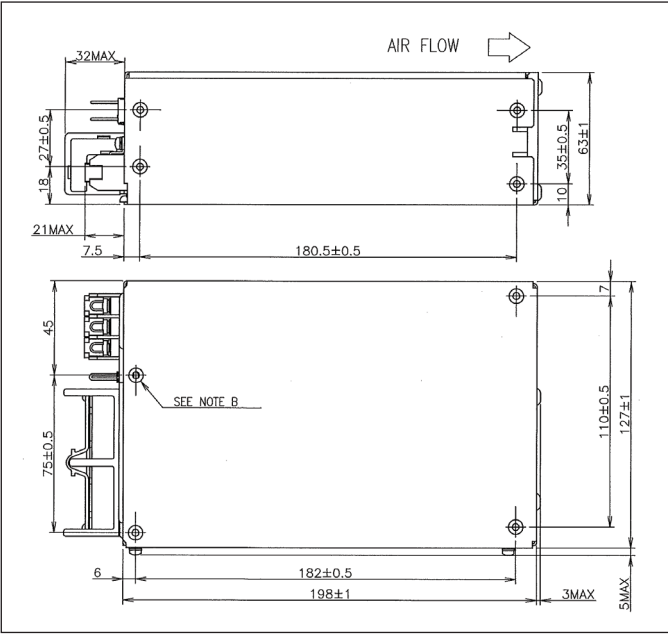

Outline Drawing RWS1500B/ME

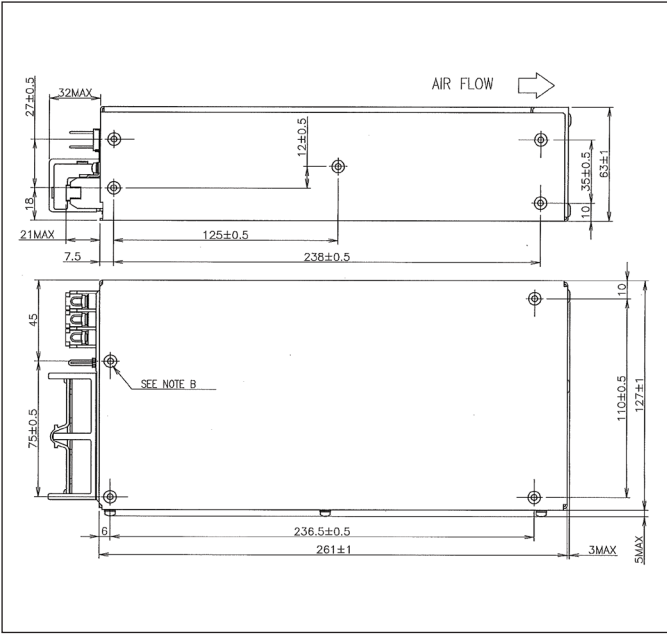



TDK-Lambda France SAS

Tel: +33 1 60 12 71 65
france@fr.tdk-lambda.com
www.emea.lambda.tdk.com/fr



Italy Sales Office

Tel: +39 02 61 29 38 63
info.italia@it.tdk-lambda.com
www.emea.lambda.tdk.com/it



Netherlands

info@nl.tdk-lambda.com
www.emea.lambda.tdk.com/nl



TDK-Lambda Germany GmbH

Tel: +49 7841 666 0
info@de.tdk-lambda.com
www.emea.lambda.tdk.com/de



Austria Sales Office

Tel: +43 2256 655 84
info@at.tdk-lambda.com
www.emea.lambda.tdk.com/at



Switzerland Sales Office

Tel: +41 44 850 53 53
info@ch.tdk-lambda.com
www.emea.lambda.tdk.com/ch



Nordic Sales Office

Tel: +45 8853 8086
info@dk.tdk-lambda.com
www.emea.lambda.tdk.com/dk



TDK-Lambda UK Ltd.

Tel: +44 (0) 12 71 85 66 66
info@uk.tdk-lambda.com
www.emea.lambda.tdk.com/uk



TDK-Lambda Ltd.

Tel: +9 723 902 4333
info@tdk-lambda.co.il
www.emea.lambda.tdk.com/il



C.I.S.

Commercial Support:

Tel: +7 (495) 665 2627

Technical Support:

Tel: +7 (812) 658 0463
info@tdk-lambda.ru
www.emea.lambda.tdk.com/ru



TDK-Lambda Americas

Tel: +1 800-LAMBDA-4 or 1-800-526-2324
powersolutions@us.tdk-lambda.com
www.us.lambda.tdk.com



TDK Electronics do Brasil Ltda

Tel: +55 11 3289-9599
sales.br@tdk-electronics.tdk.com
www.tdk-electronics.tdk.com/en



TDK-Lambda Corporation

Tel: +81-3-6778-1113
www.jp.lambda.tdk.com



TDK-Lambda (China) Electronics Co. Ltd.

Tel: +86 21 6485-0777
powersolutions@cn.tdk-lambda.com
www.lambda.tdk.com.cn



TDK-Lambda Singapore Pte Ltd.

Tel: +65 6251 7211
tts.mkt@sg.tdk-lambda.com
www.sg.lambda.tdk.com



TDK India Private Limited, Power Supply Division

Tel: +91 80 4039-0660
mathew.philip@in.tdk-lambda.com
www.sg.lambda.tdk.com

