

CUS600M

IMMUNITY DATA

INDEX

	PAGE
1. Summary of Immunity Test Result	2~3
----- IEC61000 Series Test Data-----	
2. Electrostatic Discharge Immunity Test (IEC61000-4-2)	4
3. Radiated Radio-Frequency Electromagnetic Field Immunity Test (IEC61000-4-3)	5
4. Electrical Fast Transient / Burst Immunity Test (IEC61000-4-4)	6
5. Surge Immunity Test (IEC61000-4-5)	7
6. Conducted Disturbances Induced by Radio-Frequency Field Immunity Test (IEC61000-4-6)	8
7. Power Frequency Magnetic Field Immunity Test (IEC61000-4-8)	9
8. Voltage Dips, Short Interruptions Immunity Test (IEC61000-4-11)	10
----- IEC60601-1-2 Series Test Data-----	
9. Electrostatic Discharge Immunity Test (IEC60601-1-2 Ed.4)	11
10. Radiated Radio-Frequency Electromagnetic Field Immunity Test (IEC60601-1-2 Ed.4)	12
11. Electrical Fast Transient / Burst Immunity Test (IEC60601-1-2 Ed.4)	13
12. Surge Immunity Test (IEC60601-1-2 Ed.4)	14
13. Conducted Disturbances Induced by Radio-Frequency Field Immunity Test (IEC60601-1-2 Ed.4)	15
14. Power Frequency Magnetic Field Immunity Test (IEC60601-1-2 Ed.4)	16
15. Voltage Dips, Voltage Interruptions Immunity Test (IEC60601-1-2 Ed.4)	17

Terminology Used

FG	Frame GND
\perp	Earth (\perp) terminal
L	Live line
N	Neutral line
\perp	Earth
+V	+ Output
-V	- Output

※ Test results are reference data based on our standard measurement condition.

1. Summary of Immunity Test Result

MODEL: CUS600M

(1) IEC61000 Series Test Result:

Item	Standard	Test level	Criteria	Result	Notes & Conditions
Electrostatic Discharge Immunity Test	IEC61000-4-2	1,2,3,4	A	PASS	
Radiated Radio-Frequency Electromagnetic Field Immunity Test	IEC61000-4-3	1,2,3	A	PASS	
Electrical Fast Transient / Burst Immunity Test	IEC61000-4-4	1,2,3,4	A	PASS	
Surge Immunity Test	IEC61000-4-5	1,2,3,(4)	A	PASS	Level 4 : Common mode only
Conducted Disturbances Induced by Radio-Frequency Field Immunity Test	IEC61000-4-6	1,2,3	A	PASS	
Power Frequency Magnetic Field Immunity Test	IEC61000-4-8	1,2,3,4	A	PASS	
Voltage Dips Immunity Test, Short Interruptions Immunity Test	IEC61000-4-11 (100~120VAC) CLASS 3 Industrial	Dip: 20% 5000ms	A/B	PASS	A : ≤ 570W, B : > 570W
		Dip: 30% 500ms	A/B	PASS	A : ≤ 500W, B : > 500W
		Dip: 60% 200ms	A/B	PASS	A : ≤ 210W, B : > 210W
		Dip: 100% 20ms	A/B	PASS	A : ≤ 330W, B : > 330W
		Dip: 100% 10ms	A	PASS	
		Dip: 100% 5000ms	B	PASS	
	IEC61000-4-11 (200~240VAC) CLASS 3 Industrial	Dip: 20% 5000ms	A	PASS	
		Dip: 30% 500ms	A	PASS	
		Dip: 60% 200ms	A/B	PASS	A : ≤ 570W, B : > 570W
		Dip: 100% 20ms	A/B	PASS	A : ≤ 330W, B : > 330W
		Dip: 100% 10ms	A	PASS	
		Dip: 100% 5000ms	B	PASS	

Detail of test condition refer to each test page.

Criteria A

1. The regulation of output voltage must not exceed 5% of initial value during test.
2. The output voltage must be within the regulation of specification after the test.
3. Smoke and fire are not allowed.

Criteria B

1. Must not have temporary function degradation that requires input restart.
2. The output voltage must be within the regulation of specification after the test.
3. Smoke and fire are not allowed.

1. Summary of Immunity Test Result

MODEL: CUS600M

(2) IEC60601-1-2 Series Test Result:

Item	Standard	Test level	Criteria	Result	Notes & Conditions
Electrostatic Discharge Immunity Test	IEC60601-1-2 Ed.4	1,2,3,4	A	PASS	ENCLOSURE PORT
Radiated Radio-Frequency Electromagnetic Field Immunity Test	IEC60601-1-2 Ed.4	1,2,3	A	PASS	ENCLOSURE PORT
Electrical Fast Transient / Burst Immunity Test	IEC60601-1-2 Ed.4	1,2,3	A	PASS	Input a.c. power PORT
Surge Immunity Test	IEC60601-1-2 Ed.4	1,2,3	A	PASS	Input a.c. power PORT
Conducted Disturbances Induced by Radio-Frequency Field Immunity Test	IEC60601-1-2 Ed.4	1,2	A	PASS	Input a.c. power PORT
Power Frequency Magnetic Field Immunity Test	IEC60601-1-2 Ed.4	1,2,3,4	A	PASS	ENCLOSURE PORT
Voltage Dips Immunity Test, Short Interruptions Immunity Test	IEC60601-1-2. Ed4 (100~120VAC)	Dip: 30% 500ms	A/B	PASS	A : $\leq 500W$, B : $> 500W$
		Dip: 100% 10ms	A	PASS	
		Dip: 100% 20ms	A/B	PASS	A : $\leq 330W$, B : $> 330W$
		Dip: 100% 5000ms	B	PASS	
Voltage Dips Immunity Test, Short Interruptions Immunity Test	IEC60601-1-2. Ed4 (200~240VAC)	Dip: 30% 500ms	A	PASS	
		Dip: 100% 10ms	A	PASS	
		Dip: 100% 20ms	A/B	PASS	A : $\leq 330W$, B : $> 330W$
		Dip: 100% 5000ms	B	PASS	

Detail of test condition refer to each test page.

Criteria A

1. The regulation of output voltage must not exceed 5% of initial value during test.
2. The output voltage must be within the regulation of specification after the test.
3. Smoke and fire are not allowed.

Criteria B

1. Must not have temporary function degradation that requires input restart.
2. The output voltage must be within the regulation of specification after the test.
3. Smoke and fire are not allowed.

2. Electrostatic Discharge Immunity Test (IEC61000-4-2)

MODEL : CUS600M

(1) Equipment Used

Electro Static Discharge Simulator : ZSS-S3011A (NOISEKEN)

Discharge Resistance : 330Ω Capacity : 150pF

(2) Test Conditions

- Input Voltage : 115, 230VAC
- Output Voltage : Rated
- Output Current : 0%, 100%
- Polarity : +, -
- Test Times : 10 times
- Discharge Interval : > 1 second
- Ambient Temperature : 25°C

(3) Test Method and Device Test Point

Contact Discharge : ⚡, Mounting screw

Air Discharge : ⚡, Mounting screw, Input and output terminal

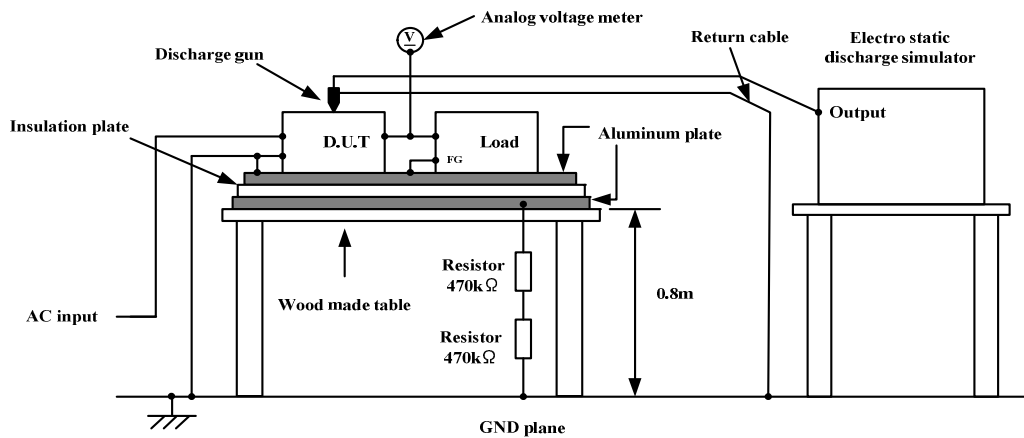

(4) Acceptable Conditions

1. The regulation of output voltage must not exceed 5% of initial value during test.
2. The output voltage must be within the regulation of specification after the test.
3. Smoke and fire are not allowed.

(5) Test Result

Contact Discharge (kV)	CUS600M-12/19/24/28/32/36/48	Air Discharge(kV)	CUS600M-12/19/24/28/32/36/48
2	PASS	2	PASS
4	PASS	4	PASS
6	PASS	8	PASS
8	PASS	15	PASS

3. Radiated Radio-Frequency Electromagnetic Field Immunity Test (IEC61000-4-3)

MODEL : CUS600M

(1) Equipment Used

SML 03(RS CORPORATION)
 HL 046(RS CORPORATION)
 AR500W 1000A(AR CORPORATION)
 FM5004(AR CORPORATION)
 FP6001(AR CORPORATION)

(2) Test Conditions

- Input Voltage : 115, 230VAC
- Output Voltage : Rated
- Output Current : 0%, 100%
- Amplitude Modulated : 80%, 1kHz
- Wave Angle : Horizontal and Vertical
- Ambient Temperature : 25°C
- Sweep Condition : 1.0% Step Up, 0.5 Seconds Hold
- Distance : 3.0m
- Test Angle : Top/Bottom, Both Sides, Front/Back
- Electromagnetic Frequency : 80~1000MHz , 1.4~2.0GHz, 2.0~2.7GHz

(3) Test Method

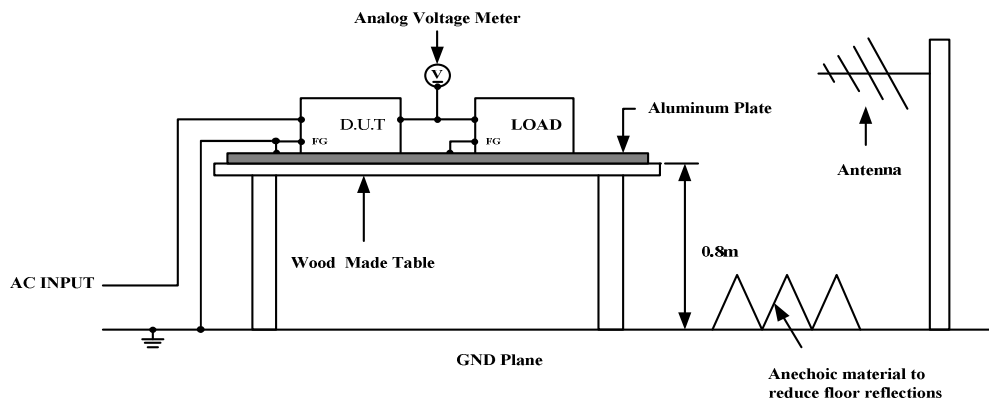

(4) Acceptable Conditions

1. The regulation of output voltage must not exceed 5% of initial value during test.
2. The output voltage must be within the regulation of specification after the test.
3. Smoke and fire are not allowed.

(5) Test Result

Radiation Field Strength (V/m)	Electromagnetic Frequency	CUS600M-12/19/24/28/32/36/48
1	2.0~2.7GHz	PASS
3	1.4~2.0GHz	PASS
10	80~1000MHz	PASS

4. Electrical Fast Transient / Burst Immunity Test (IEC61000-4-4)

MODEL : CUS600M

(1) Equipment Used

EFT/B Generator : FNS-AX3 (NOISEKEN)

(2) Test Conditions

- Input Voltage : 115, 230VAC
- Output Voltage : Rated
- Output Current : 0%, 100%
- Test Time : 1 minute
- Polarity : +, -
- Ambient Temperature : 25°C
- Number of Tests : 1 time
- Pulse Frequency : 5kHz / 100kHz
- Burst Time : 15msec / 0.75msec
- Number of Pulse : 75pcs
- Burst Cycle : 300msec

(3) Test Method and Device Test Point

Apply to (N, L, $\frac{\perp}{\perp}$), (N, L), (N), (L), ($\frac{\perp}{\perp}$)

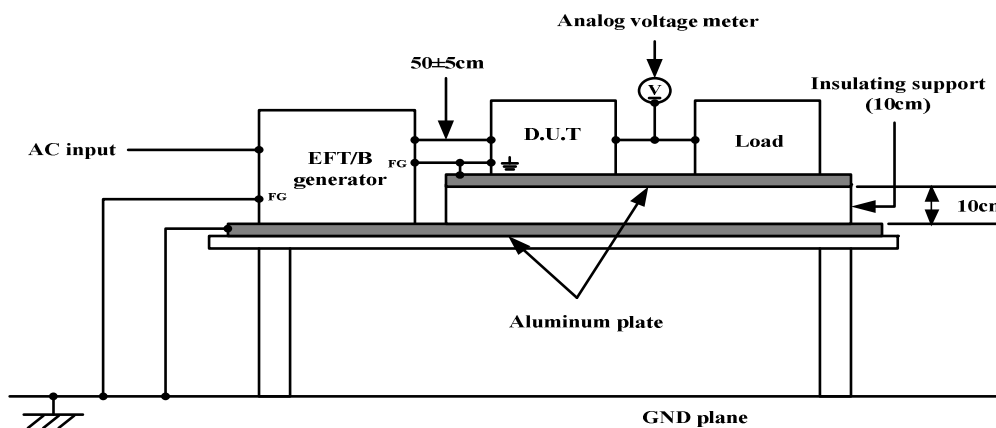

(4) Acceptable Conditions

1. The regulation of output voltage must not exceed 5% of initial value during test.
2. The output voltage must be within the regulation of specification after the test.
3. Smoke and fire are not allowed.

(5) Test Result

Test Voltage (kV)	Repetition Rate (kHz)	CUS600M-12/19/24/28/32/36/48
0.5	5 / 100	PASS
1	5 / 100	PASS
2	5 / 100	PASS
4	5 / 100	PASS

6. Conducted Disturbances Induced by Radio-Frequency Field Immunity Test (IEC61000-4-6)

MODEL : CUS600M

(1) Equipment Used

Compact RF Simulator : NSG 4070-30 (TESEQ)
 Coupling-Decoupling Network : CDN L-801 M2/M3 (Liithi)

(2) Test Conditions

• Input Voltage : 115, 230VAC • Output Voltage : Rated
 • Output Current : 100% • Electromagnetic Frequency : 150kHz~80MHz
 • Ambient Temperature : 25°C
 • Sweep Condition : 1.0% Step Up, 0.5 Seconds Hold

(3) Test Method

Apply to (N, L, ϕ)

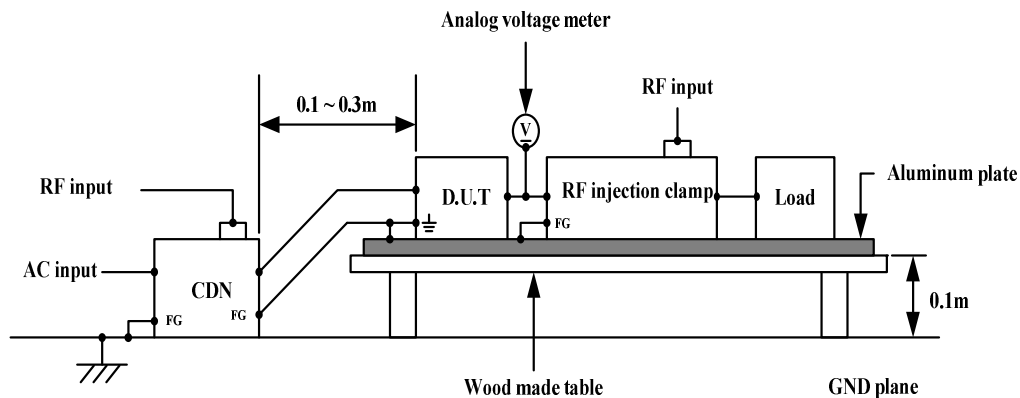

(4) Acceptable Conditions

1. The regulation of output voltage must not exceed 5% of initial value during test.
2. The output voltage must be within the regulation of specification after the test.
3. Smoke and fire are not allowed.

(5) Test Result

Voltage Level (V)	CUS600M- 12/19/24/28/32/36/48
1	PASS
3	PASS
10	PASS

7. Power Frequency Magnetic Field Immunity Test (IEC61000-4-8)

MODEL : CUS600M

(1) Equipment Used

AC Power Source : NSG 1007(SCHAFFNER)
 Helmholtz Coil : R-1000-4-8/9-L-1M (TESEQ)

(2) Test Conditions

- Input Voltage : 115, 230VAC
- Output Voltage : Rated
- Output Current : 100%
- Magnetic Frequency : 50Hz
- Ambient Temperature : 25°C
- Direction : X, Y, Z
- Test Time : More than 10 seconds (each direction)

(3) Test Method and Device Test Point

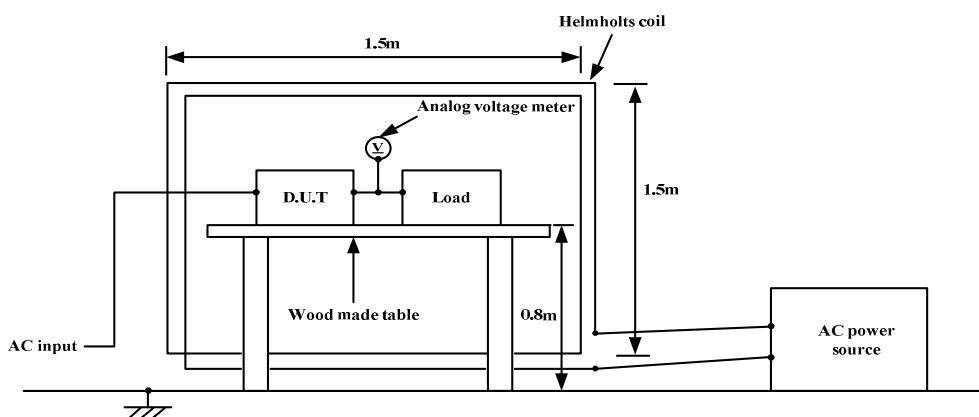

(4) Acceptable Conditions

1. The regulation of output voltage must not exceed 5% of initial value during test.
2. The output voltage must be within the regulation of specification after the test.
3. Smoke and fire are not allowed.

(5) Test Result

Magnetic Field Strength (A/m)	CUS600M-12/19/24/28/32/36/48
1	PASS
3	PASS
10	PASS
30	PASS

8. Voltage Dips, Short Interruptions Immunity Test (IEC61000-4-11)

MODEL : CUS600M

(1) Equipment Used

Test Generator : PCR2000LA (KIKUSUI)

(2) Test Conditions

- Input Voltage : 100 ~ 120VAC, 200~ 240VAC
- Output Voltage : Rated
- Output Current : 100%
- Ambient Temperature : 25°C
- Number of Tests : 3 times
- Test interval : More than 10 seconds

(3) Test Method and Device Test Point

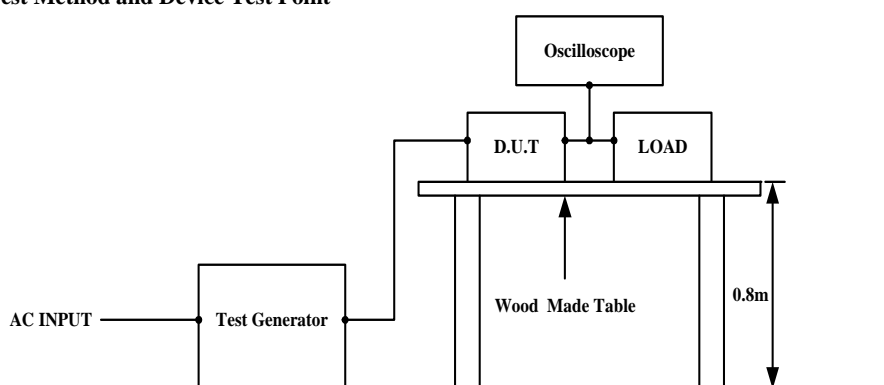

(4) Acceptable Conditions

Criteria A

1. The regulation of output voltage must not exceed 5% of initial value during test.
2. The output voltage must be within the regulation of specification after the test.
3. Smoke and fire are not allowed.

Criteria B

1. Must not have temporary function degradation that requires input restart.
2. The output voltage must be within the regulation of specification after the test.
3. Smoke and fire are not allowed.

(5) Test Result

Phenomenon	Test Level	Dip rate	Continue Time	Input Voltage Range	Criteria	CUS600M-12/19/24/28/32/36/48
Voltage dips	80%	20%	5000ms	100 ~ 120VAC	A : ≤ 570W, B : > 570W	PASS
				200 ~ 240VAC	A	PASS
	70%	30%	500ms	100 ~ 120VAC	A : ≤ 500W, B : > 500W	PASS
				200 ~ 240VAC	A	PASS
	40%	60%	200ms	100 ~ 120VAC	A : ≤ 210W, B : > 210W	PASS
				200 ~ 240VAC	A : ≤ 570W, B : > 570W	PASS
0%	100%	20ms	100 ~ 120VAC	A : ≤ 330W, B : > 330W	PASS	
			200 ~ 240VAC	A : ≤ 330W, B : > 330W	PASS	
Short Interruptions	0%	100%	10ms	100 ~ 120VAC	A	PASS
				200 ~ 240VAC	A	PASS
Short Interruptions	0%	100%	5000ms	100 ~ 120VAC	B	PASS
				200 ~ 240VAC	B	PASS

9. Electrostatic Discharge Immunity Test (IEC60601-1-2 Ed.4)

MODEL: CUS600M

(1) Equipment Used

Electro Static Discharge Simulator : ZSS-S3011A (NOISEKEN)

Discharge Resistance : 330Ω Capacity : 150pF

(2) Test Conditions

- Input Voltage : 100, 240VAC • Output Voltage : Rated
- Output Current : 0%, 100% • Polarity : +, -
- Number of Tests : 10 times • Discharge Interval : >1 second
- Ambient Temperature : 25°C

(3) Test Method and Device Test Point (IEC61000-4-2, ENCLOSURE PORT)

Contact Discharge : ⚡, Mounting screw

Air Discharge : ⚡, Mounting screw, Input and output terminal

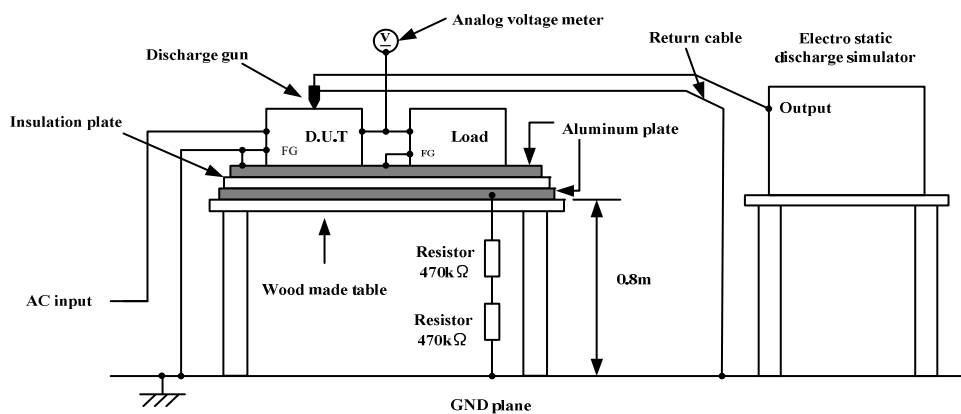

(4) Acceptable Conditions

1. The regulation of output voltage must not exceed 5% of initial value during test.
2. The output voltage must be within the regulation of specification after the test.
3. Smoke and fire are not allowed.

(5) Test Result

Contact Discharge (kV)	CUS600M-12/19/24/28/32/36/48	Air Discharge(kV)	CUS600M-12/19/24/28/32/36/48
2	PASS	2	PASS
4	PASS	4	PASS
6	PASS	8	PASS
8	PASS	15	PASS

10. Radiated Radio-Frequency Electromagnetic Field Immunity Test (IEC60601-1-2 Ed.4)

MODEL: CUS600M

(1) Equipment Used

Signal generator	: MG3692B (Anritsu)
Power amplifier system	: AP32 SW210 (PRANA)
	: AP32 MT255 (PRANA)
Electric field sensor	: HI-6105 (ETS-Lindgren)
Bilog antenna	: AT4510 (AR)
	: VULP9118E(SCHWARZBECK)

(2) Test Conditions

- Input Voltage : 100, 240VAC
- Output Voltage : Rated
- Output Current : 0%, 100%
- Distance(AM) : 3.0m
- Wave Angle : Horizontal and Vertical
- Distance(FM,PM) : 0.3m
- Test Angle : Top/Bottom, Both Sides, Front/Back
- Ambient Temperature : 25°C
- Amplitude Modulated(AM) : 80%, 1kHz, 1.0% step up, 0.5 seconds hold.
- Pulse Modulated(PM) : 18Hz, 217Hz, 0.5 seconds hold
- Frequency Modulated(FM) : 5kHz deviation, 1kHz sine, 0.5 seconds hold.

(3) Test Method (IEC61000-4-3, ENCLOSURE PORT)

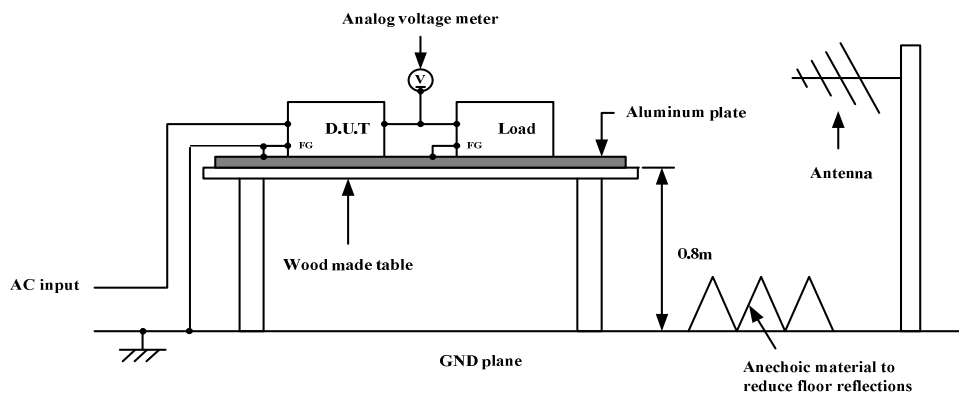

(4) Acceptable Conditions

1. The regulation of output voltage must not exceed 5% of initial value during test.
2. The output voltage must be within the regulation of specification after the test.
3. Smoke and fire are not allowed.

(5) Test Result

Modulation	Radiation Field Strength (V/m) (Level 3)	Electromagnetic Frequency	CUS600M- 12/19/24/28/32/36/48
AM	10	80MHz ~2.7GHz	PASS
PM (18Hz)	27	385MHz	PASS
	28	810,870,930MHz	PASS
PM (217Hz)	9	710,745,780,5240,5500,5785MHz	PASS
	28	1720,1845,1970,2450MHz	PASS
FM	28	450MHz	PASS

11. Electrical Fast Transient / Burst Immunity Test (IEC60601-1-2 Ed.4)

MODEL: CUS600M

(1) Equipment Used

EFT/B Generator : FNS-AX3 (NOISEKEN)

(2) Test Conditions

- Input Voltage : 100, 240VAC
- Output Voltage : Rated
- Output Current : 0%, 100%
- Test Time : 1 minute
- Polarity : +, -
- Ambient Temperature : 25°C
- Number of Tests : 1 time
- Pulse Frequency : 100kHz
- Burst Time : 0.75msec
- Number of Pulse : 75pcs
- Burst Cycle : 300msec

(3) Test Method and Device Test Point (IEC61000-4-4, Input a.c. power PORT)

Apply to (N, L, $\frac{\perp}{\perp}$), (N, L), (N), (L), ($\frac{\perp}{\perp}$)

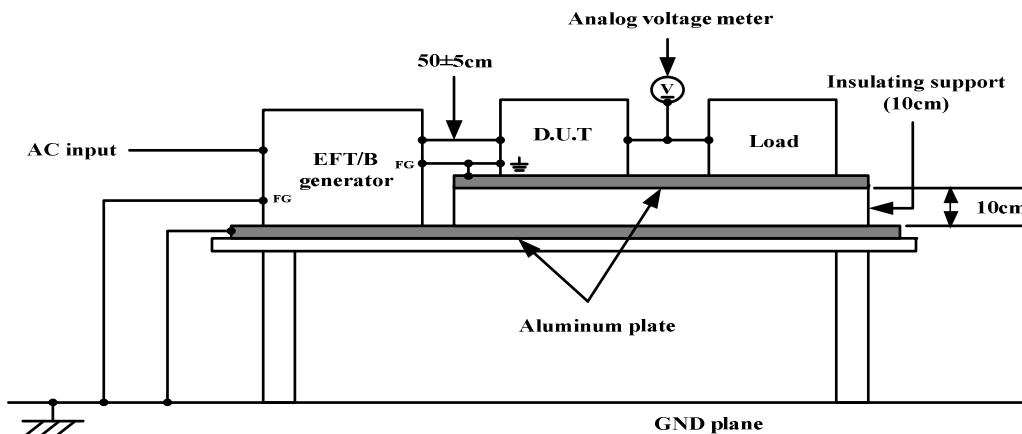

(4) Acceptable Conditions

1. The regulation of output voltage must not exceed 5% of initial value during test.
2. The output voltage must be within the regulation of specification after the test.
3. Smoke and fire are not allowed.

(5) Test Result

Test Voltage (kV) (Level 3)	CUS600M- 12/19/24/28/32/36/48
0.5	PASS
1	PASS
2	PASS

12. Surge Immunity Test (IEC60601-1-2 Ed.4)

MODEL: CUS600M

(1) Equipment Used

Surge Generator : LSS-F03 (NOISEKEN)

Coupling Impedance	: Common	12Ω	Coupling Capacitance	: Common	9μF
	Normal	2Ω		Normal	18μF

(2) Test Conditions

- Input Voltage : 100, 240VAC
- Output Voltage : Rated
- Output Current : 0%, 100%
- Number of Tests : 5 times
- Polarity : +, -
- Mode : Common , Normal
- Phase : 0, 90deg
- Ambient Temperature : 25°C

(3) Test Method and Device Test Point (IEC61000-4-5, Input a.c. power PORT)

Apply to Common mode (N- ≍, L- ≍) and Normal mode (N-L)

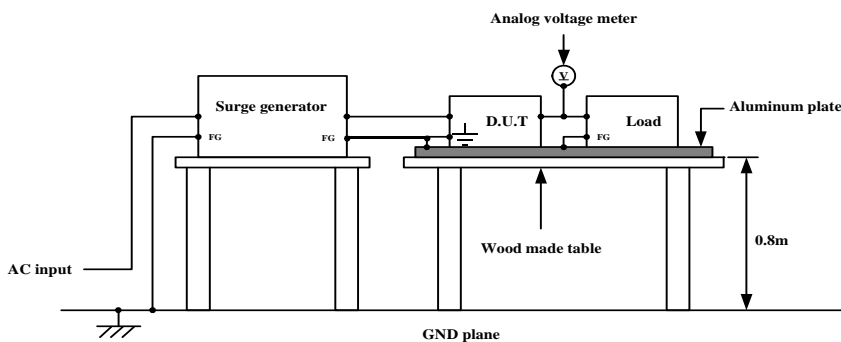

(4) Acceptable Conditions

1. The regulation of output voltage must not exceed 5% of initial value during test.
2. The output voltage must be within the regulation of specification after the test.
3. Smoke and fire are not allowed.

(5) Test Result

Common(Level 3)		Normal(Level 2)	
Test Voltage (kV)	CUS600M- 12/19/24/28/32/36/48	Test Voltage (kV)	CUS600M- 12/19/24/28/32/36/48
0.5	PASS	0.5	PASS
1	PASS	1	PASS
2	PASS		

13. Conducted Disturbances Induced by Radio-Frequency Field Immunity Test (IEC60601-1-2 Ed.4)

MODEL: CUS600M

(1) Equipment Used

Compact RF Simulator : NSG 4070-30 (TESEQ)

Coupling-Decoupling Network : CDN L-801 M2/M3 (Liithi)

(2) Test Conditions

- Input Voltage : 100, 240VAC • Output Voltage : Rated
- Output Current : 100% • Electromagnetic Frequen : 150kHz~80MHz
- Ambient Temperature : 25°C
- Sweep Condition : 1.0% step up, 0.5 seconds hold

(3) Test Method and Device Test Point (IEC61000-4-6, Input a.c. power PORT)

Apply to (N, L, \perp)

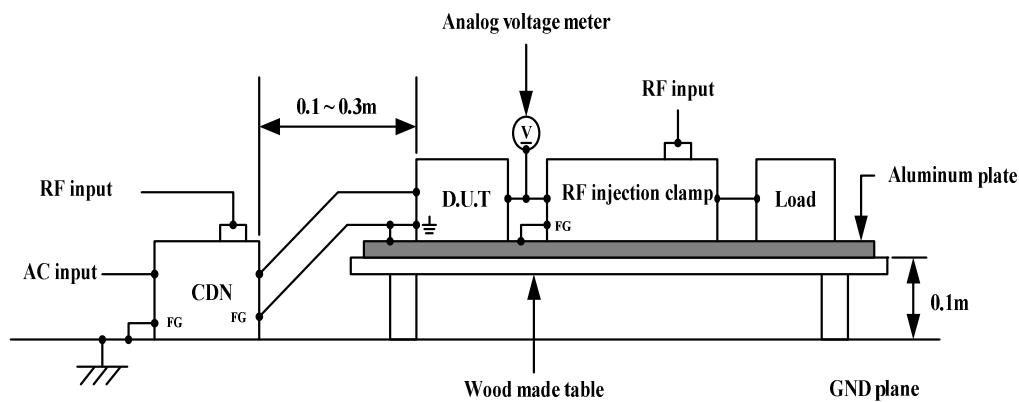

(4) Acceptable Conditions

1. The regulation of output voltage must not exceed 5% of initial value during test.
2. The output voltage must be within the regulation of specification after the test.
3. Smoke and fire are not allowed.

(5) Test Result

Voltage Level (V) (Level 2)	CUS600M- 12/19/24/28/32/36/48
1	PASS
3	PASS

14. Power Frequency Magnetic Field Immunity Test (IEC60601-1-2 Ed.4)

MODEL: CUS600M

(1) Equipment Used

AC Power Source : NSG 1007(SCHAFFNER)
 Helmholtz Coil : R-1000-4-8/9-L-1M (TESEQ)

(2) Test Conditions

- Input Voltage : 100, 240VAC
- Output Voltage : Rated
- Output Current : 100%
- Magnetic Frequency : 50Hz
- Ambient Temperature : 25°C
- Direction : X, Y, Z
- Test Time : More than 10 seconds (each direction)

(3) Test Method (IEC61000-4-8, ENCLOSURE PORT)

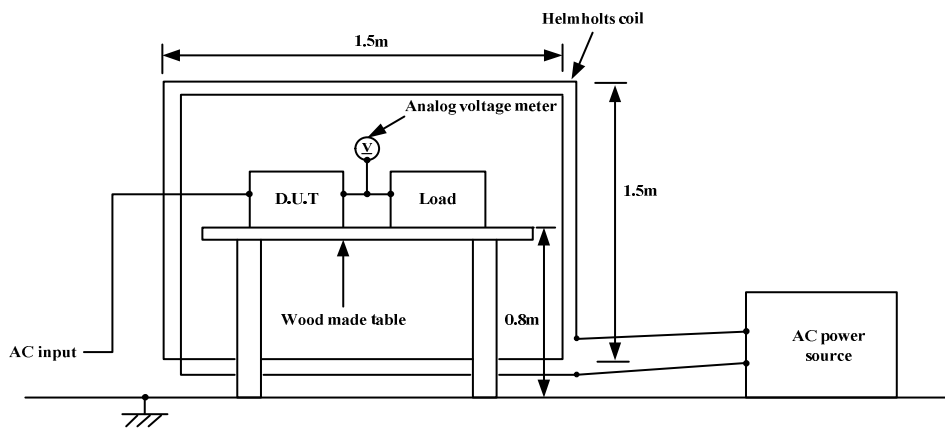

(4) Acceptable Conditions

1. The regulation of output voltage must not exceed 5% of initial value during test.
2. The output voltage must be within the regulation of specification after the test.
3. Smoke and fire are not allowed.

(5) Test Result

Magnetic Field Strength (A/m) (Level 4)	CUS600M-12/19/24/28/32/36/48
1	PASS
3	PASS
10	PASS
30	PASS

15. Voltage Dips, Voltage Interruptions Immunity Test (IEC60601-1-2 Ed.4)

MODEL: CUS600M

(1) Equipment Used

Test generator : PCR2000LA (KIKUSUI)

(2) Test Conditions

- Input Voltage : 100, 240VAC
- Output Voltage : Rated
- Output Current : 100%
- Ambient Temperature : 25°C
- Number of Tests : 3 times
- Test Interval : More than 10 seconds

(3) Test Method (IEC61000-4-11, Input a.c. power PORT)

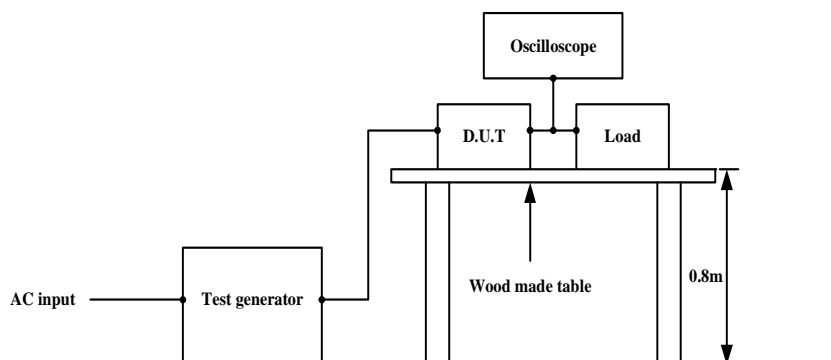

(4) Acceptable Conditions

Criteria A

1. The regulation of output voltage must not exceed 5% of initial value during test.
2. The output voltage must be within the regulation of specification after the test.
3. Smoke and fire are not allowed.

Criteria B

1. Must not have temporary function degradation that requires input restart.
2. The output voltage must be within the regulation of specification after the test.
3. Smoke and fire are not allowed.

(5) Test Result

Phenomenon	Test Level	Continue Time	Phase Angles	Input Voltage Range	Criteria	CUS600M-12/19/24/28/32/36/48
Voltage dips	70%	500ms	0 deg	100VAC	A : ≤ 500W, B : > 500W	PASS
				240VAC	A	PASS
	0%	10ms	0,45,90,135,180,225,270,315 deg	100VAC	A	PASS
				240VAC	A	PASS
0%	20ms	0 deg	100VAC	A : ≤ 330W, B : > 330W	PASS	
			240VAC	A : ≤ 330W, B : > 330W	PASS	
Voltage interruptions	0%	5000ms	0 deg	100VAC	B	PASS
				240VAC	B	PASS