



Short Form Installation User's Manual			 www.nextys.com Nextys SA. Via Luserte Sud 6, 6572 Quartino – Switzerland Phone: +41-(0)91 8401446 / 8401448; Fax: +41-(0)91 8401447
Models	12V Super Capacitors Module		
File No.:	I.M.NCP12	Rev.:	A01





Use latest device Documentation, Software and Firmware to ensure reliable operation of the system
(downloadable from www.nextys.com)



READ THIS CAREFULLY BEFORE INSTALLATION!	LEGGERE ATTENTAMENTE PRIMA DELL'INSTALLAZIONE!	A LIRE ATTENTIVEMENT AVANT L'INSTALLATION!
<p>Before operating, read this document thoroughly and retain it for future reference.</p> <p>Non-respect of these instructions may reduce performances and safety of the devices and cause danger for people and property. The products must be installed, operated, serviced and maintained by qualified personnel in compliance with applicable standards and regulations.</p> <p>Don't open the device, it does not contain replaceable components, the tripping of the internal fuse (if included) is caused by an internal failure.</p> <p>Don't repair or modify the device, if malfunction or failure should occur during operation, send unit to the factory for inspection. No responsibility is assumed by Nextys SA for any consequences deriving from the use of this material.</p>	<p>Prima dell'installazione, leggere attentamente questo documento istruzioni e conservarle per future consultazioni.</p> <p>L'inosservanza delle presenti istruzioni può compromettere le caratteristiche e la sicurezza dell'apparecchio e causare pericolo per le persone e le cose.</p> <p>Il prodotto deve essere installato, utilizzato e riparato da personale qualificato e nel rispetto delle normative vigenti.</p> <p>Non aprire il prodotto, esso non contiene componenti sostituibili, il guasto del fusibile interno (se previsto) è causato da un guasto interno. Non tentare di riparare o modificare il prodotto, se durante il funzionamento si verificano guasti o anomalie, inviarlo al produttore per il controllo.</p> <p>Nextys SA non si assume nessuna responsabilità per qualunque conseguenza derivante dall'uso di questo materiale.</p>	<p>Lire ces instructions avant l'installation, conserver ce manuel pour référence future.</p> <p>Défaut de se conformer à ces instructions peut affecter les caractéristiques et la sécurité du dispositif, et causer du danger aux personnes ou aux biens.</p> <p>Les produits doivent être installés, exploités et entretenus par du personnel qualifié et en conformité avec les règlements.</p> <p>N'ouvrez pas le produit, il ne contient aucune pièce réparable, le déclenchement du fusible interne (le cas échéant) est causé par un défaut interne. Ne pas essayer de réparer ou modifier le produit ; si des défaillances se produisent pendant le fonctionnement, retourner le produit au fabricant pour inspection. Nextys SA n'assume aucune responsabilité des conséquences éventuelles découlant de l'utilisation des produits.</p>
CAUTION	ATTENZIONE	AVVERTISSEMENT
<p>RISK OF BURNS, EXPLOSION, FIRE, ELECTRICAL SHOCK, PERSONAL INJURY.</p> <p>Never carry out work on live parts! Danger of fatal injury! The product's enclosure may be hot, allow time for cooling product before touching it. Do not allow liquids or foreign objects to enter into the products.</p> <p>To avoid sparks, do not connect or disconnect the device before having previously turned-off input power and wait for internal capacitors discharge (minimum 1 minute).</p>	<p>RISCHIO USTIONI, ESPLOSIONE, INCENDIO, SCOSSA, LESIONI GRAVI.</p> <p>Non effettuare mai operazioni sulle parti sotto tensione! Pericolo di lesioni letali! Il contenitore può scottare, lasciar quindi raffreddare il dispositivo prima di toccarlo. Non far entrare liquidi o oggetti estranei nel dispositivo.</p> <p>Per evitare scintille, non collegare o scollegare l'apparecchiatura prima di avere tolto tensione di ingresso e prima che sia avvenuta la scarica dei condensatori interni (min. 1 minuto).</p>	<p>RISQUE DE BRULURES, EXPLOSION, INCENDIE, ELECTROCUTION, DOMMAGE AUX PERSONNES.</p> <p>Ne jamais effectuer des opérations sur les parties sous tension! Danger de mort! Le boîtier peut produire des brûlures, le laisser refroidir avant de toucher l'appareil. Ne faire pas pénétrer des liquides ou des corps étrangers dans l'appareil. Pour éviter des étincelles, ne pas connecter ou déconnecter l'équipement jusqu'à ce que la tension d'entrée a été supprimée et avant qu'il n'ait eut lieu la décharge des condensateurs internes (minimum 1 minute).</p>
INTENDED USE	USO PREVISTO	UTILISATION
<p>These are isolated devices suitable for SELV and PELV circuitry and are designed to be mounted on DIN rail and installed inside a protective enclosure. They are intended for general use such as in industrial control, communication, and instrumentation equipment.</p> <p>Don't use these devices in applications where malfunction may cause injury or death.</p>	<p>I dispositivi sono isolati, adatti per applicazioni SELV e PELV, sono dotati di aggancio per il montaggio su guida DIN all'interno di quadri elettrici o contenitori di protezione, per l'utilizzo con controllori industriali, unità di comunicazione o apparecchi di misura.</p> <p>Non utilizzare in applicazioni in cui un eventuale guasto può comportare rischio di lesioni o di morte.</p>	<p>Les produits sont isolés, appropriés pour les circuits TBTS et TBTP et sont équipés d'un crochet pour montage sur rail DIN dans des armoires ou conteneurs de protection, pour utilisation avec les contrôleurs industriels, des modules de communication ou des unités de mesure.</p> <p>Ne pas utiliser ces dispositifs dans une application où un dysfonctionnement pourrait entraîner le risque des blessures ou de mort.</p>
ENVIRONMENTAL CHARACTERISTICS	CARATTERISTICHE AMBIENTALI	CARACTÉRISTIQUES ENVIRONNEMENTALES
<p>Installation in a Pollution Degree 2 environment, Overvoltage Category I, according to IEC60664-1.</p> <p>Do not use in wet area or subject to moisture.</p> <p>Carefully recycle the product and related batteries according to local regulations.</p>	<p>Usare in ambienti con Grado di Inquinamento 2 e Categoria di Sovratensione I, secondo IEC60664-1.</p> <p>Non far funzionare l'apparecchio in un ambiente umido o soggetto a formazione di condensa. Riciclare il prodotto e le batterie collegate, nel rispetto delle normative locali vigenti.</p>	<p>Utiliser les produits dans des environnements avec degré de pollution 2, catégorie de surtension I selon IEC60664-1.</p> <p>Ne pas employer l'appareil dans un environnement humide ou soumis à la condensation. Recycler les produits et les batteries, conformément à la réglementation locale.</p>

Declaration of Conformity	
	<p>NEXTYS SA. Via Luserte Sud 6, 6572 Quartino - Switzerland Phone: +41-(0)91 840 14 46 / 840 14 48; Fax: +41-(0)91 840 14 47 E-mail: info@nextys.com</p>
<p>This Declaration of Conformity is suitable to the European Standard EN45014 "General criteria for supplier's declaration of conformity". We declare under our sole responsibility that the device included in this box, has passed all processing inspections and the final test and it is in conformity with the product requirements, including all reference codes and supply specifications.</p>	
<p>ROHS compliance: the product respects the EC requirements related to ROHS substances, according to "Restriction of Hazardous Substances" as per document 2011/65/UE</p> <p>REACH compliance: the product respects the EC requirements related to REACH SVHC directive (2015)</p> <p>Note: all the reported information comes from our suppliers, NEXTYS SA. has not run any test to evaluate if the specific elements are present.</p>	
<p>All indicated devices are designed according to the latest Reference standards, if not expressly indicated through the official documents or files, they have been tested through our internal pre-compliance testing. Consult directly on www.nextys.com the reference standards applied to each model.</p>	

Code NCP12	Description Super Capacitors Module 12V/60F/7.6kJ
Certifications and approvals	  
Reference standards	<p>2014/35/EU (2014) (Low Voltage Directive)</p> <p>2014/30/EU (2014) (EMC directive)</p> <p>UL508 (Certified - IND. CONT. EQ. 4WX9 file no. E356563)</p> <p>EN61010-1 (Safety Standard)</p> <p>EN61010-2-201 (Safety Standard)</p> <p>EN61000-6-2 (Generic immunity standard for industrial environments)</p> <p>- EN61000-4-2 (Electrostatic discharge immunity test)</p> <p>- EN61000-4-3 (Radiated, radio-frequency, electromagnetic field immunity test)</p> <p>- EN61000-4-4 (Electrical fast transient/burst immunity test)</p> <p>- EN61000-4-5 (Surge immunity test)</p> <p>EN61000-6-3 (Generic emission standard for residential environments)</p> <p>- EN55022 (CISPR22 - EMC)</p> <p>- EN55011 (CISPR11 - EMC)</p>

INSTRUCTIONS

- 1) Description:** NCP12 is a Super Capacitors Module providing up to 7.6kJ (2.1Wh) energy storage capability. It can be used to replace batteries for short term backup function.
 - 2) Installation:** use DIN-rails according to EN 60715. Installation should be made vertically (see Fig.4). For better device stability fix the rail to the wall close to the point where the device is to be mounted. In order to guarantee sufficient convection, we recommend observing a minimum distance to other modules (see Fig.3).
 - 3) Connections:** the device is equipped with pluggable screw terminals. To avoid sparks, do not connect or disconnect the connectors before having previously turned-off input power and waited for capacitors discharge.
In order to comply with local certification, use appropriate copper cables of indicated cross section, designed for an operating temperatures of
60°C for ambient up to 45°C
75°C for ambient up to 60°C
90°C for ambient up to 70°C.
Strip the connecting ends of the wires according to the indication on Fig.5 and ensure that all strands of a stranded wire enter the terminal connection.
 - 4) Protections:** To prevent damage in case of reverse polarity or short circuit the device is protected by a user replaceable 30A/32V ATO blade fuse.
For continued protection replace with same type and ratings of fuse only. The maximum allowed charge voltage is 16VDC with a temporary overvoltage of max. 17VDC. Exceeding these values will decrease product life dramatically and possibly triggering the overvoltage protection leading to fuse failure.
 - 5) Series and parallel connection:** To increase the backup time and / or the available current several NCP12 can be connected in series / parallel arrangements. From the user point of view the NCP12 is exactly equivalent to a 12V battery so that every series / parallel combination performed with 12V batteries can be done also with NCP12. When used in conjunction with DCW20 UPS module the maximum number of NCP12 connectable in series is 3, because of the maximum charge voltage limitation of the DCW20.
 - 6) Safety precautions:** NCP12 can provide extremely high current when short circuited, **do not short circuit.** A short circuit when the NCP12 is charged will lead to fuse failure. When NCP12 is fully charged at 16VDC it will remain charged for days, avoid storing or shipping when not fully discharged before; **do not short circuit** to discharge NCP12. Charging NCP12 at voltage above 17VDC can lead to severe damage to the unit.
When connecting several NCP12 in series / parallel please discharge every NCP12; **never connect in parallel a charged unit with a discharged unit;** fuses of both units will fail.
 - 7) Operating temperature:** is recommended using in the following conditions
-40°C...+85°C when the environmental conditions is above 65°C derating voltage -120mV/°C.
 - 8) Warranty:** NCP12 is guaranteed free from factory defects for the time specified in the "Sales Conditions".
Failures caused by misuse, external and/or abnormal events (i.e. overvoltage, over temperatures) or non-respect of above parameters and standards, are not covered by warranty. Opening the housing of the product makes warranty to be no longer valid.
- See also the products below that can be used in conjunction with NCP12 unit:**
- **DCU20** 20A High performance DC UPS
 - **DCW20** 20A High performance DC UPS/DC-DC Converter
 - **NUPSxx** Battery Charger and DC UPS

In order to improve the products Nextys SA reserves the right to change product specifications, ratings and data without previous advice.

Input / Output connections

Example: parallel connections system using *NEXTYS* DCW20 UPS

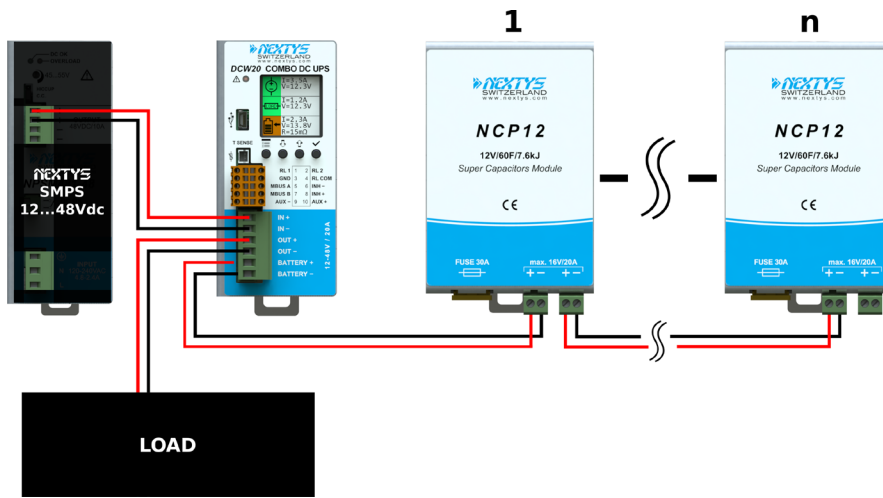

Example: series connections system using *NEXTYS* DCW20 UPS

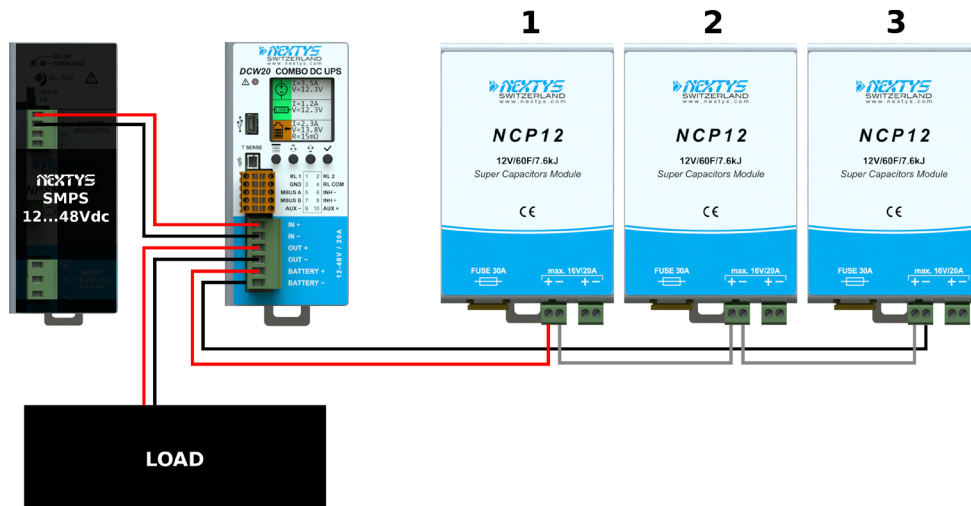

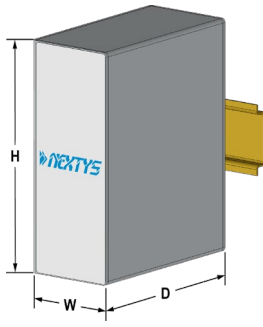
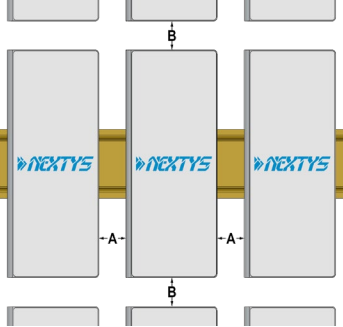
Connections	Dimensions	Distances (Fig.3)															
 <p>1. Input/Output: double IO connection (paralleled) 2. FUSE: 30A/32V ATA blade user replaceable</p>																	
<p>Input/Output Connection:</p> <ul style="list-style-type: none"> ■ + = Positive DC ■ - = Negative DC 	<table border="1"> <thead> <tr> <th>Dimension</th> <th>mm</th> </tr> </thead> <tbody> <tr> <td>W</td> <td>80.0</td> </tr> <tr> <td>H</td> <td>120.0</td> </tr> <tr> <td>D</td> <td>100.0</td> </tr> </tbody> </table>	Dimension	mm	W	80.0	H	120.0	D	100.0	<table border="1"> <thead> <tr> <th>Distance</th> <th>mm</th> </tr> </thead> <tbody> <tr> <td>A</td> <td>20</td> </tr> <tr> <td>B</td> <td>20</td> </tr> </tbody> </table>		Distance	mm	A	20	B	20
Dimension	mm																
W	80.0																
H	120.0																
D	100.0																
Distance	mm																
A	20																
B	20																

Mounting / Dismounting Instructions (Fig.4)
 For DIN rail mounting according to IEC 60715 TH35-7.5(-15). Mounting as shown in figure, with input terminals on lower side, with suitable cooling and maintaining a proper distance between adjacent devices as specified in the User manual.

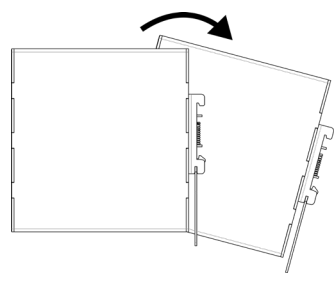
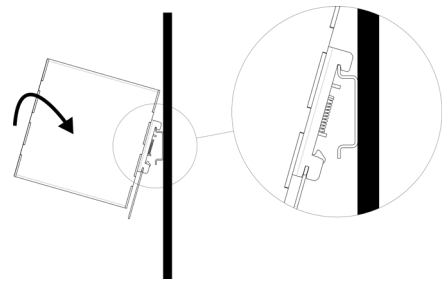
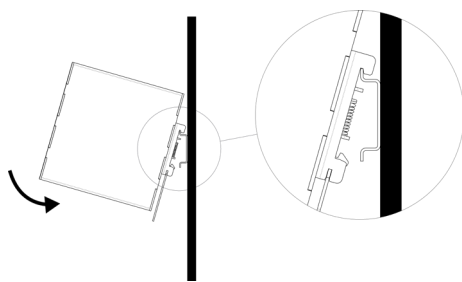
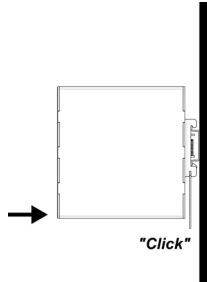
Mounting	
<ol style="list-style-type: none"> 1. Tilt the unit slightly backwards. 2. Fit the unit over the top edge of the rail. 3. Slide it downward until it hits the stop. 4. Press against the bottom for locking. 	 <p style="text-align: center;">1</p>  <p style="text-align: center;">2</p>  <p style="text-align: center;">3</p>  <p style="text-align: center;">4</p>

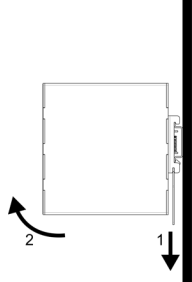
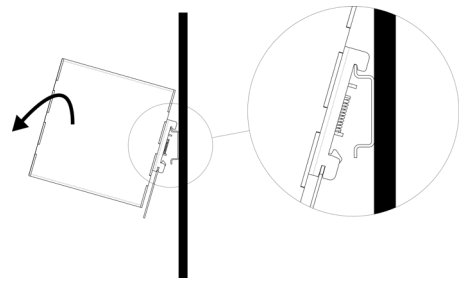
Dismounting	
<ol style="list-style-type: none"> 1. Pull down the slide clamp lever. 2. Tilt the unit upward. 3. Unhook the unit from the rail. 	 <p style="text-align: center;">1 & 2</p>  <p style="text-align: center;">3</p>

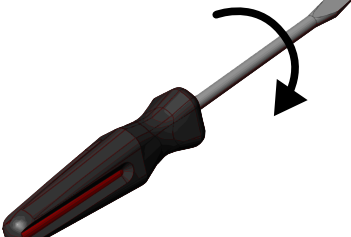
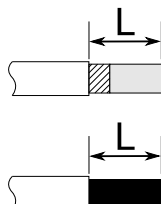
Recommended connecting cable (Fig.5)			
	<p>Recommended Tightening torque</p> <p>0.5-0.6Nm 4.42-5.30 lbf in</p>		<p>Input / output connections</p> <p>Solid: 2.5mm² / 12AWG Stranded: 2.5mm² / 12AWG L: 6.0-7.5mm / 0.24-0.30in</p>

