

DPX20-xxWSxx Single Output: DC-DC Converter Module

9.5 ~ 36VDC, 18 ~ 75VDC input; 3.3 to 15VDC Single Output
20 Watts Output Power



FEATURES

- NO MINIMUM LOAD REQUIRED
- 1600VDC INPUT TO OUTPUT ISOLATION
- SCREW TERMINALS FOR INPUT AND OUTPUT CONNECTIONS
- RELIABLE SNAP-ON FOR DIN RAIL TS-35/7.5 OR TS-35/15
- CASE PROTECTION MEETS IP20(IEC60529)
- INPUT FUSE PROTECTION
- INPUT REVERSE POLARITY PROTECTION
- INPUT IN-RUSH CURRENT LIMIT CIRCUIT
- OUTPUT DC-OK INDICATOR
- 4:1 WIDE INPUT VOLTAGE RANGE
- FIXED SWITCHING FREQUENCY
- INPUT UNDER-VOLTAGE PROTECTION
- OUTPUT OVER-VOLTAGE PROTECTION
- OVER-CURRENT PROTECTION
- OUTPUT SHORT CIRCUIT PROTECTION
- MEETS EN55022 CLASS B
- REMOTE ON/OFF
- COMPLIANT TO RoHS II & REACH



CE MARKED

SAFETY MEETS: UL60950-1
EN60950-1
IEC60950-1

APPLICATIONS

- COMMUNICATION SYSTEMS
- INDUSTRY CONTROL SYSTEMS
- FACTORY AUTOMATION EQUIPMENT
- SEMICONDUCTOR EQUIPMENT

OPTIONS

- REMOTE ON/OFF

GENERAL DESCRIPTION

The DPX20-xxWSxx series was designed for applications requiring din rail mountable DC-DC converters. Easy installation is provided with snap-on mounting to the DIN-rail. Internal circuits provide protection against reverse input voltage, input in-rush current, output short-circuit, output over-current, and output over-voltage conditions. A green LED at the front panel displays the status of the output voltage.

Contents

Output Specifications	3
Input Specifications	4
General Specifications	5
Environmental Specifications	5
EMC Characteristics	5
Characteristic Curves	
DPX20-24WS3P3	6
DPX20-24WS05	8
DPX20-24WS12	10
DPX20-24WS15	12
DPX20-48WS3P3	14
DPX20-48WS05	16
DPX20-48WS12	18
DPX20-48WS15	20
Input Source Impedance	22
Output Over Current Protection	22
Output Short Circuit Protection	22
Output Over Voltage Protection	22
Remote On/off Control	23
EMS Considerations	24
Mechanical Data	24
Packaging Information	24
Part Number Structure	25
MTBF and Reliability	25

Output Specifications

Parameter	Model	Min	Typ	Max	Unit
Output Voltage (Vin(nom); Full Load; Ta=25°C)	xxWS3P3 xxWS05 xxWS12 xxWS15	3.251 4.95 11.88 14.85	3.3 5 12 15	3.349 5.05 12.12 15.15	VDC
Output Regulation Line (Vin(min) to Vin(max); Full Load) Load (0% to 100% of Full Load)	All All	-0.2 -1.5		+0.2 +1.5	%
Output Ripple and Noise Peak to Peak (20MHz Bandwidth)	xxWS3P3 xxWS05 xxWS12 xxWS15		60 75 75 75	85 100 100 100	mVp-p
Voltage Adjustability	All	-10		+10	% of Vout
Temperature Coefficient	All	-0.02		+0.02	%/°C
Output Voltage Overshoot (Vin(min) to Vin(max) Full Load; Ta=25°C)	All		0	5	% of Vout
Dynamic Load Response (Vin(nom); Ta=25°C) Load step change from 75% to 100% or 100 to 75% of Full Load Peak Deviation Settling Time (Vo < 10% peak deviation)	All All		250 250		mV µs
Output Current	xxWS3P3 xxWS05 xxWS12 xxWS15	0 0 0 0		5.5 4 1.67 1.33	A
Output Capacitance Load	xxWS3P3 xxWS05 xxWS12 xxWS15			18000 9600 1650 1050	µF
Output Over Voltage Protection (see page 22) (Zener diode clamp)	xxWS3P3 xxWS05 xxWS12 xxWS15		3.9 6.2 15 18		VDC
Output Indicator	All		Green LED		
Output Over Current Protection (see page 22) (% of Iout rated; Hiccup mode)	All		150		% of FL
Output Short Circuit Protection (see page 22)	All		Continuous, automatic recovery		

Input Specifications

Parameter	Model	Min	Typ	Max	Unit
Operating Input Voltage Continuous	24WSxx	9.5	24	36	VDC
	48WSxx	18	48	75	
Transient (100ms,max)	24WSxx			50	
	48WSxx			100	
Input Standby Current (Vin(nom); No Load)	24WS3P3		52		mA
	24WS05		67		
	24WS12		26		
	24WS15		27		
	48WS3P3		37		
	48WS05		37		
	48WS12		18		
	48WS15		18		
Under Voltage Lockout Turn-on Threshold	24WSxx			9.5	VDC
	48WSxx			18	
Under Voltage Lockout Turn-off Threshold	24WSxx		7.5		VDC
	48WSxx		15		
Input Reflected Ripple Current (see page 22) (Vin(nom); Full Load)	All		10		mAp-p
Start Up Time (Vin(nom) and constant resistive load) Power up Remote ON/OFF	All		100		ms
			20		
Remote ON/OFF Control (see page 23) (The Ctrl pin voltage is referenced to negative input) Positive Logic (Optional) On/Off pin High Voltage (Remote ON) On/Off pin Low Voltage (Remote OFF) Negative Logic (Optional) On/Off pin Low Voltage (Remote ON) On/Off pin High Voltage (Remote OFF)	xxWSxx- P		Open or 3 ~ 12VDC Short or 0 ~ 1.2VDC		
	xxWSxx- N		Short or 0 ~ 1.2VDC Open or 3 ~ 12VDC		
Input Current of Remote Control Pin	All	-0.5		0.5	mA
Remote Off State Input Current	All		2.5		mA
Input Fuse (Slow Blow)	24WSxx		6		A
	48WSxx		4		
In-rush Current	All		15		A

General Specifications

Parameter	Model	Min	Typ	Max	Unit
Efficiency (Vin(nom); Full Load; Ta=25°C)	24WS3P3		83		%
	24WS05		86		
	24WS12		84		
	24WS15		84		
	48WS3P3		83		
	48WS05		86		
	48WS12		85		
	48WS15		85		
Isolation Voltage (1 minute) Input to Output Input to Chassis, Output to Chassis	All	1600			VDC
		1600			
Isolation Resistance (500VDC)	All	1			GΩ
Isolation Capacitance	All			4000	pF
Switching Frequency	All	360	400	440	kHz
Safety Meets	All	IEC60950-1, UL60950-1, EN60950-1			
Weight	All	147.5			g
MTBF (see page 25) MIL-HDBK-217F Ta=25°C, Full load	All	1.619 x 10 ⁶			hours
Chassis Material	All	Aluminum			

Environmental Specifications

Parameter	Model	Min	Typ	Max	Unit
Operating Ambient Temperature	Without derating	-40		+78	°C
	With derating	+78		+99	
Storage Temperature	All	-40		105	°C
Relative Humidity	All	5		95	% RH
Thermal Shock	All	MIL-STD-810F			
Vibration	All	IEC60068-2-6			

EMC Characteristics

Characteristic	Standard	Condition	Level
EMI	EN55022	Module stand-alone	Class B
ESD	EN61000-4-2	Air	±8kV
		Contact	±6kV
Radiated Immunity	EN61000-4-3	10V/m	Perf. Criteria A
Fast Transient (see page 24)	EN61000-4-4	±2kV	Perf. Criteria A
Surge (see page 24)	EN61000-4-5	±0.5kV	Perf. Criteria A
Conducted Immunity	EN61000-4-6	10V r.m.s	Perf. Criteria A
Power Frequency Magnetic Field	EN61000-4-8	100A/m continuous; 1000A/m 1 second	Perf. Criteria A

Characteristic Curves

All test conditions are at 25°C. The figures are for DPX20-24WS3P3

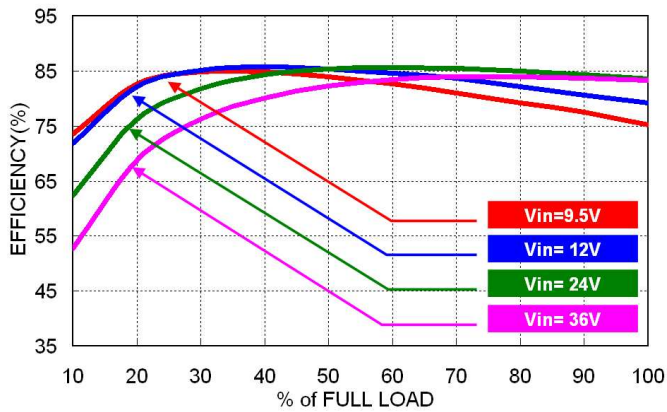

Efficiency versus Output Load

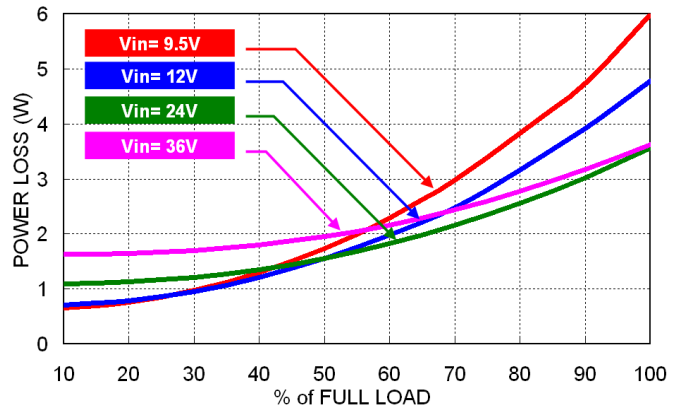

Power Dissipation versus Output Load

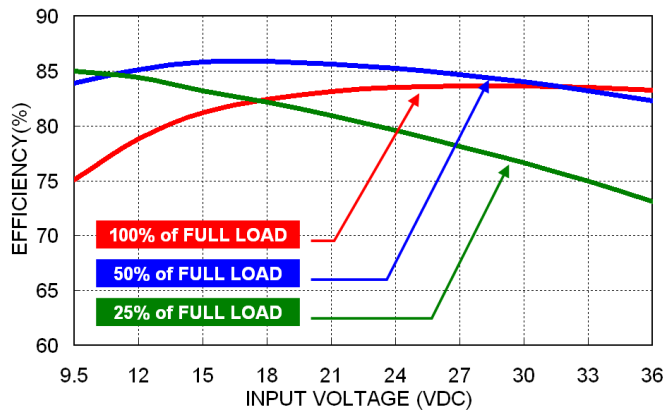

Efficiency versus Input Voltage

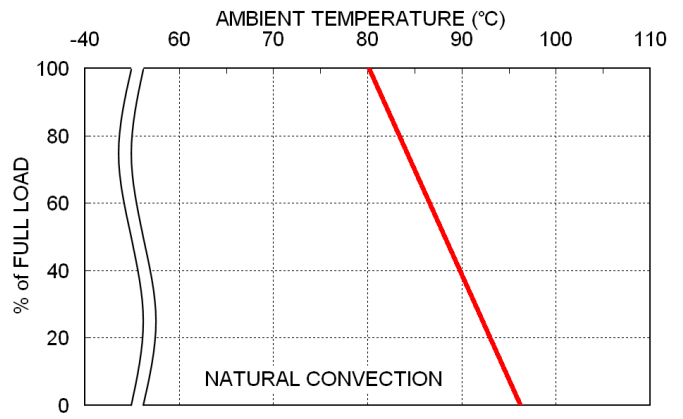

Derating Output Current versus Ambient Temperature and Airflow
Vin(nom)

Characteristic Curves (Continued)

All test conditions are at 25°C. The figures are for DPX20-24WS3P3

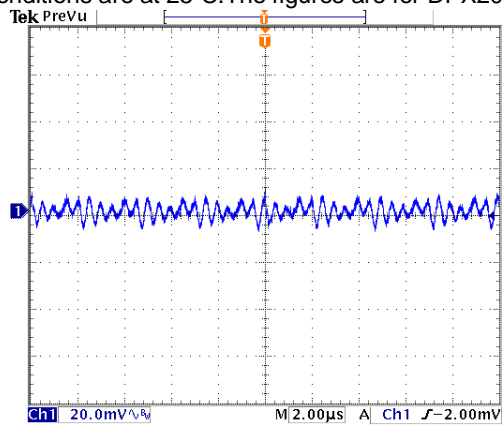

Typical Output Ripple and Noise.
Vin(nom); Full Load

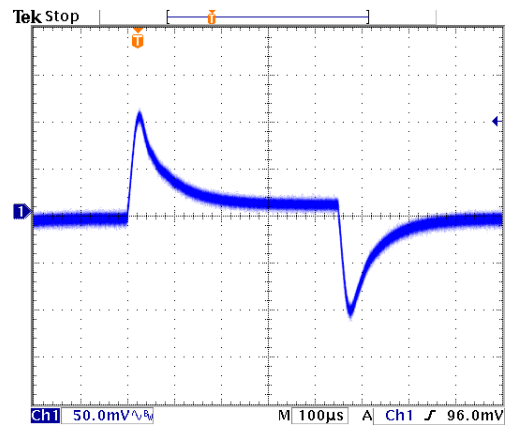

Transient Response to Dynamic Load Change from
100% to 75% to 100% of Full Load; Vin(nom)

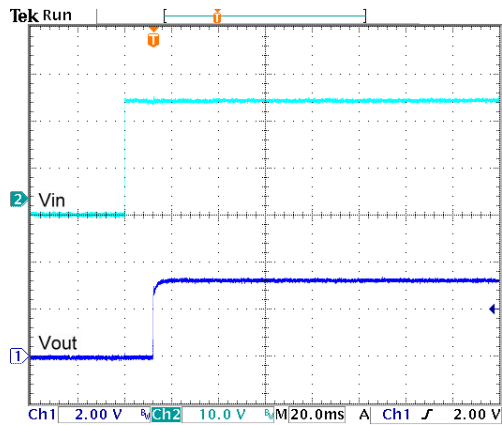

Typical Input Start-Up and Output Rise Characteristic
Vin(nom); Full Load

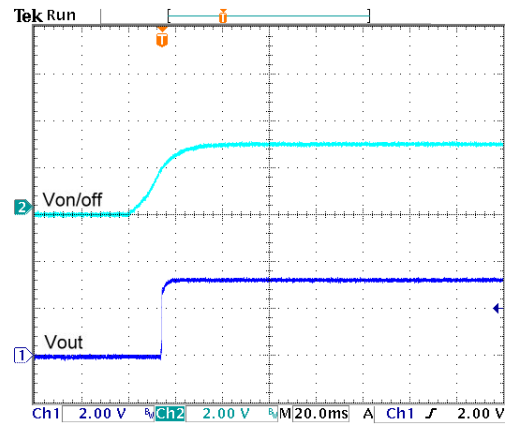

Using ON/OFF Voltage Start-Up and Output Rise Characteristic
Vin(nom); Full Load

Characteristic Curves (Continued)

All test conditions are at 25°C. The figures are for DPX20-24WS05

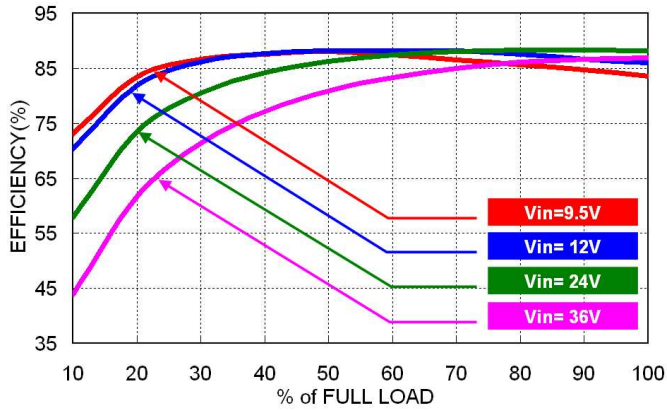

Efficiency versus Output Load

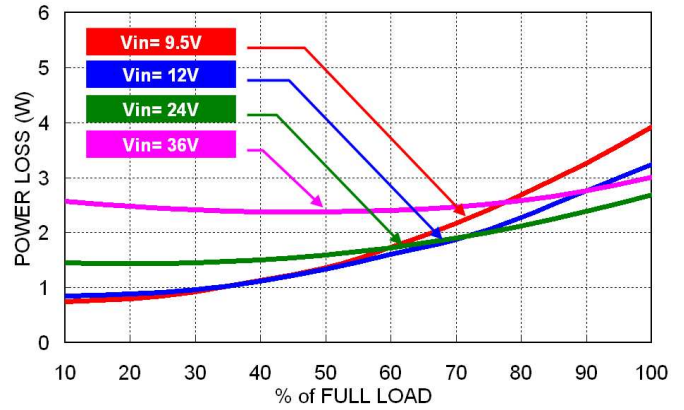

Power Dissipation versus Output Load

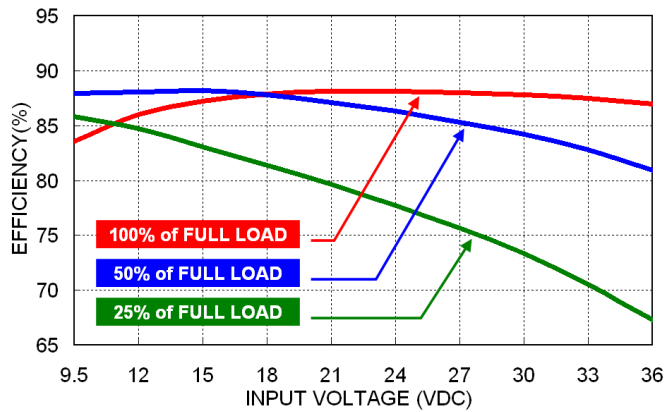

Efficiency versus Input Voltage

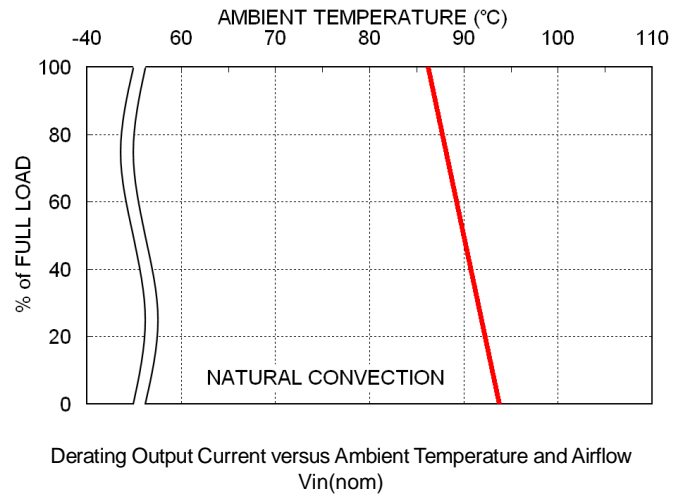

Derating Output Current versus Ambient Temperature and Airflow
V_{in}(nom)

Characteristic Curves (Continued)

All test conditions are at 25°C. The figures are for DPX20-24WS05

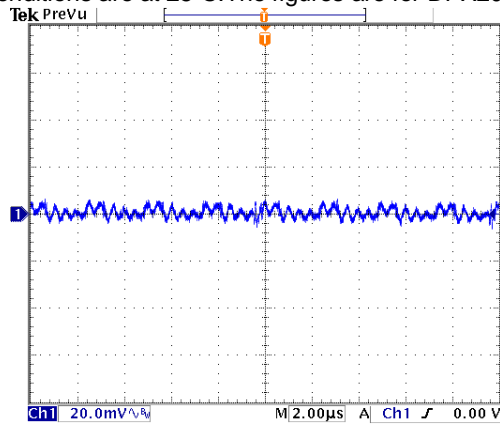

Typical Output Ripple and Noise.
Vin(nom); Full Load

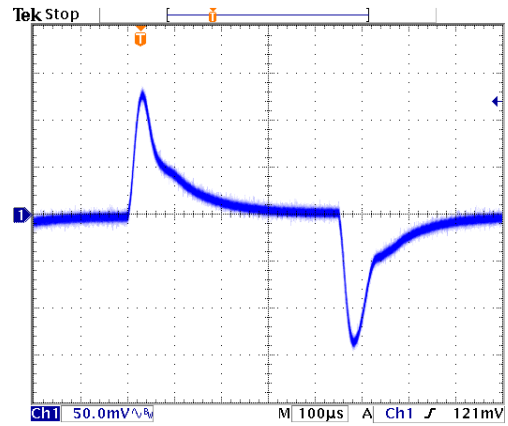

Transient Response to Dynamic Load Change from
100% to 75% to 100% of Full Load; Vin(nom)

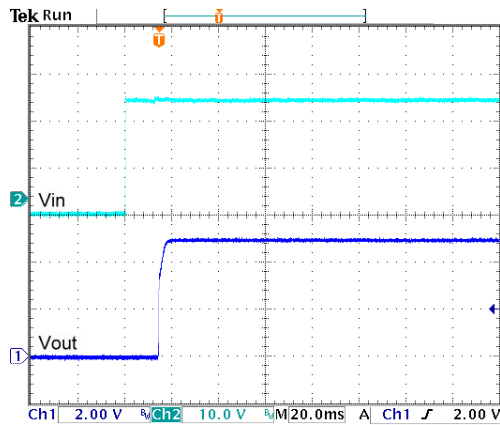

Typical Input Start-Up and Output Rise Characteristic
Vin(nom); Full Load

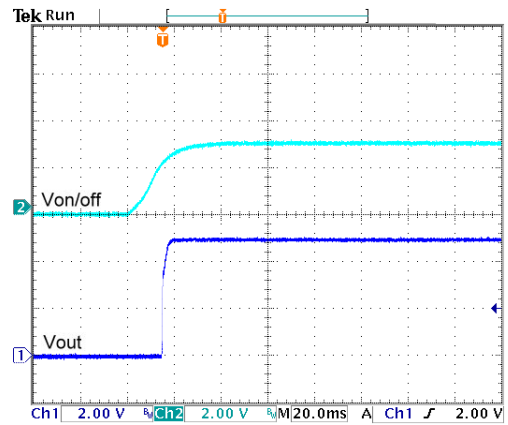

Using ON/OFF Voltage Start-Up and Output Rise Characteristic
Vin(nom); Full Load

Characteristic Curves (Continued)

All test conditions are at 25°C. The figures are for DPX20-24WS12

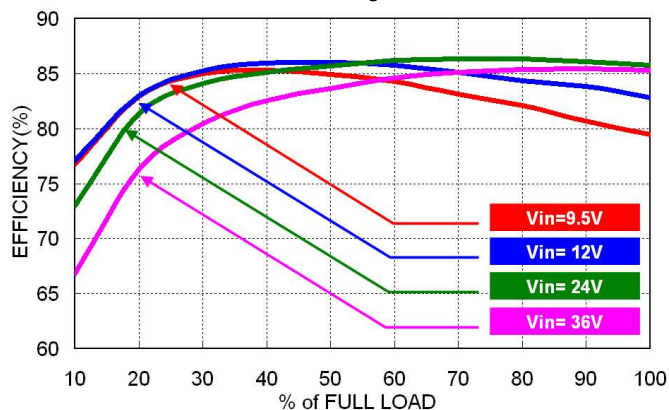

Efficiency versus Output Load

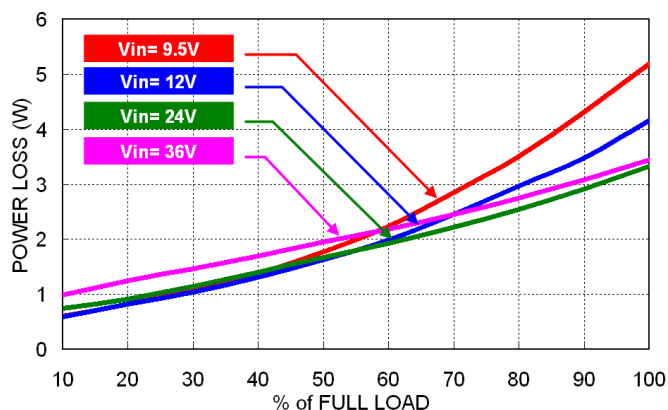

Power Dissipation versus Output Load

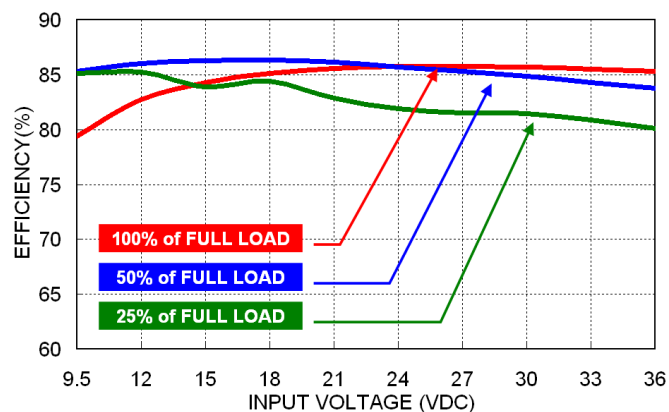

Efficiency versus Input Voltage

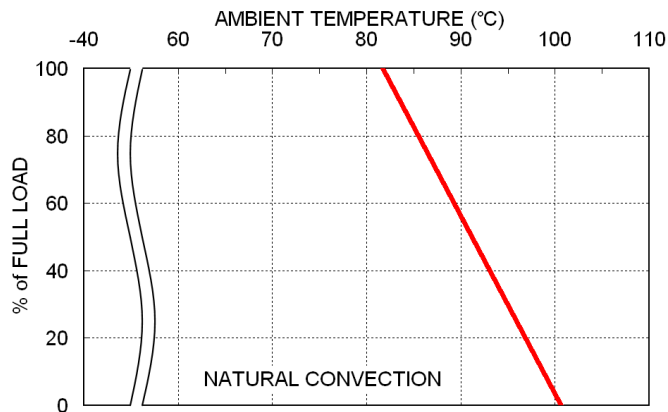

Derating Output Current versus Ambient Temperature and Airflow
Vin(nom)

Characteristic Curves (Continued)

All test conditions are at 25°C. The figures are for DPX20-24WS12

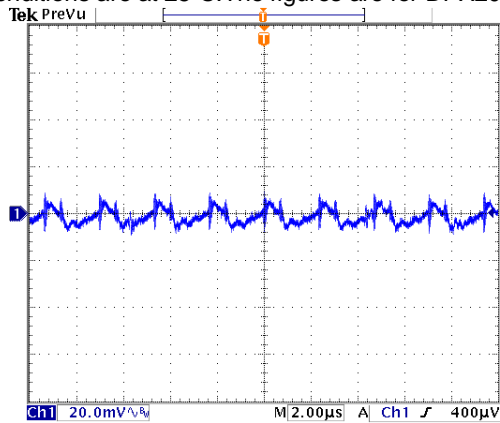

Typical Output Ripple and Noise.
Vin(nom); Full Load

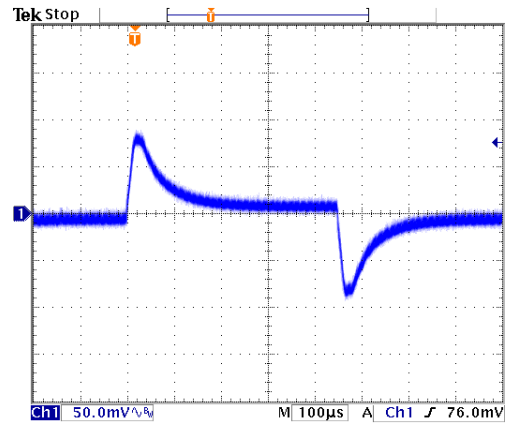

Transient Response to Dynamic Load Change from
100% to 75% to 100% of Full Load; Vin(nom)

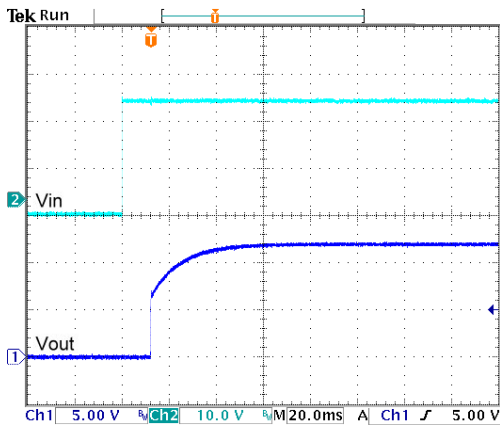

Typical Input Start-Up and Output Rise Characteristic
Vin(nom); Full Load

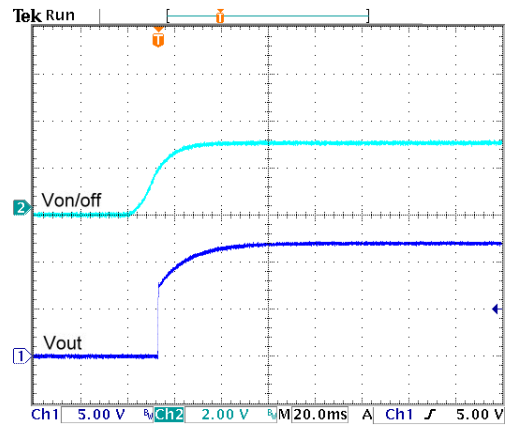

Using ON/OFF Voltage Start-Up and Output Rise Characteristic
Vin(nom); Full Load

Characteristic Curves (Continued)

All test conditions are at 25°C. The figures are for DPX20-24WS15

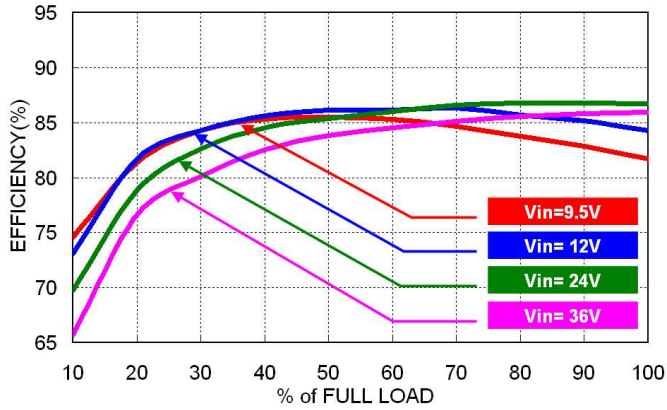

Efficiency versus Output Load

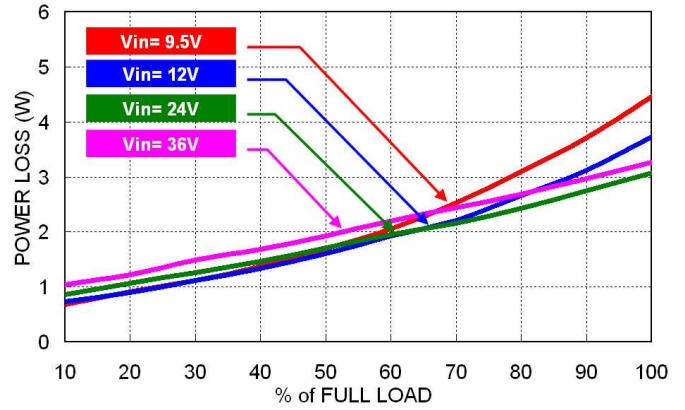

Power Dissipation versus Output Load

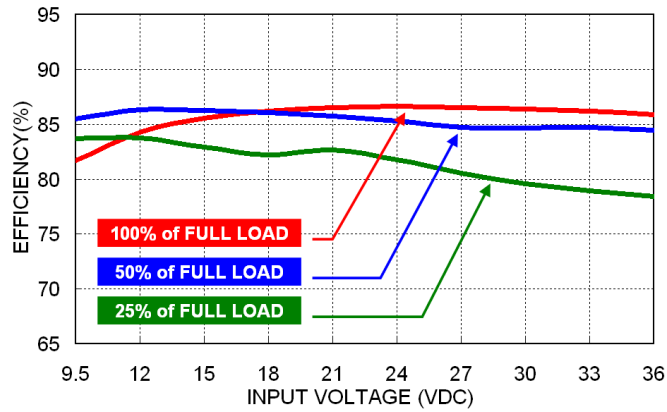

Efficiency versus Input Voltage

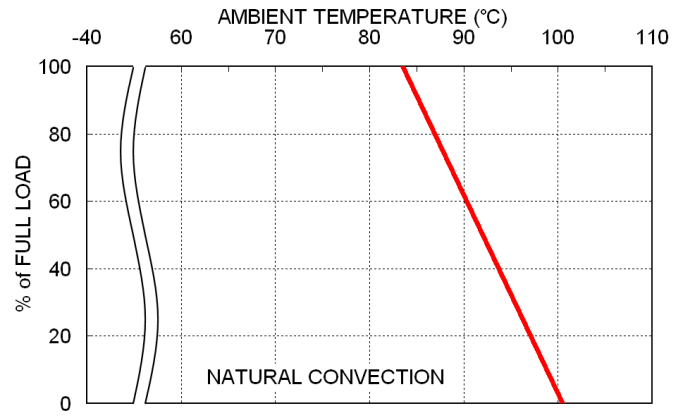

Derating Output Current versus Ambient Temperature and Airflow Vin(nom)

Characteristic Curves (Continued)

All test conditions are at 25°C. The figures are for DPX20-24WS15

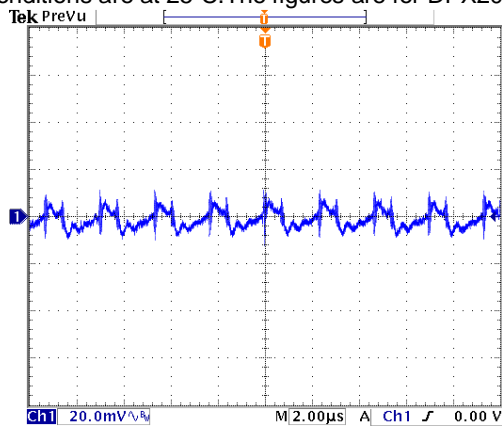

Typical Output Ripple and Noise.
Vin(nom); Full Load

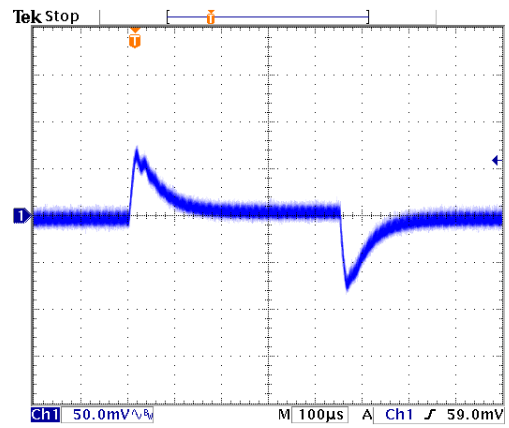

Transient Response to Dynamic Load Change from
100% to 75% to 100% of Full Load; Vin(nom)

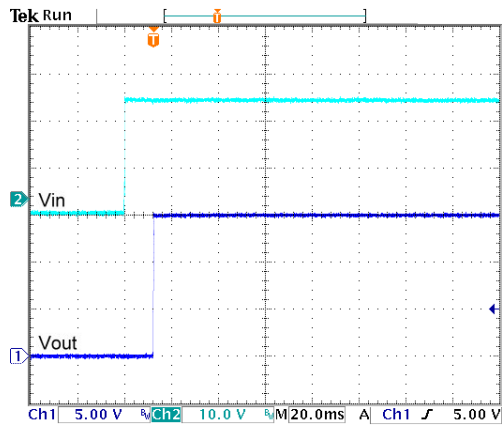

Typical Input Start-Up and Output Rise Characteristic
Vin(nom); Full Load

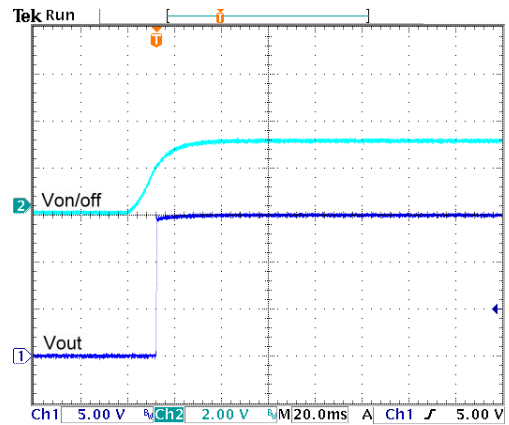

Using ON/OFF Voltage Start-Up and Output Rise Characteristic
Vin(nom); Full Load

Characteristic Curves (Continued)

All test conditions are at 25°C. The figures are for DPX20-48WS3P3

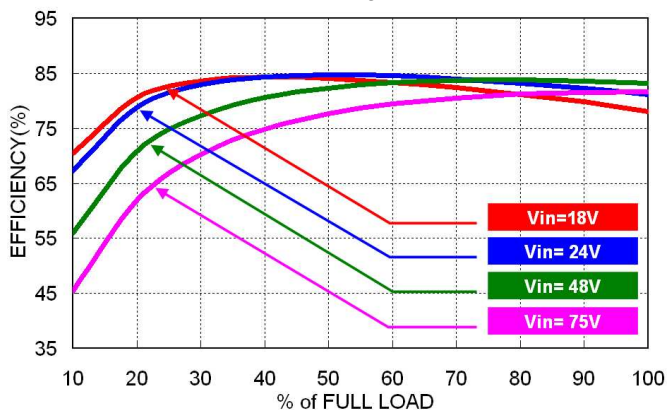

Efficiency versus Output Load

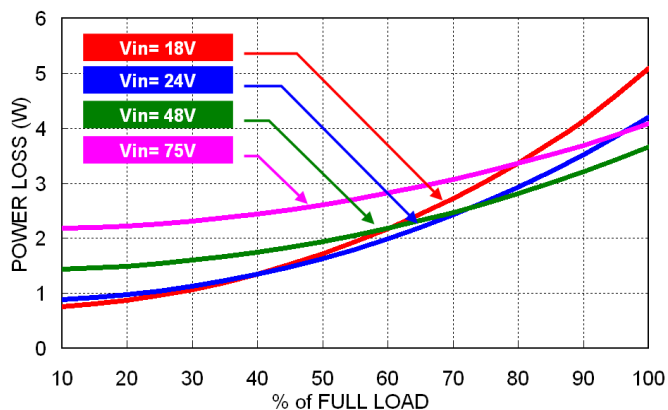

Power Dissipation versus Output Load

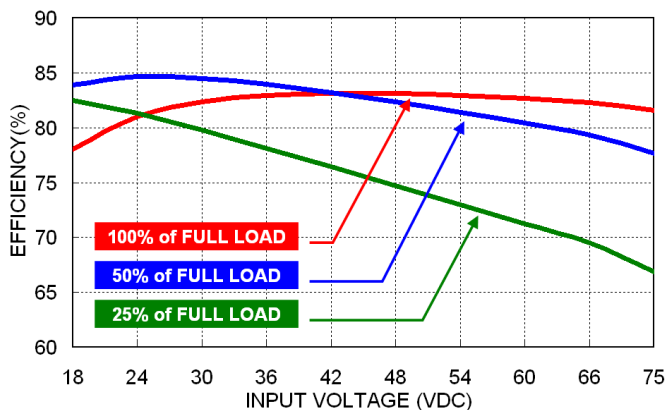

Efficiency versus Input Voltage

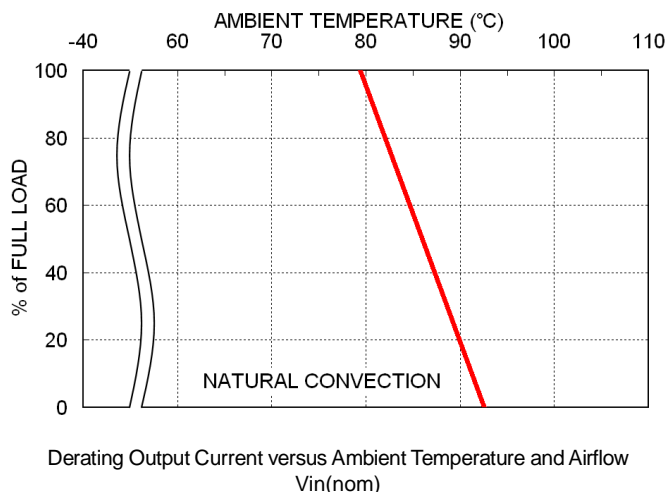

Derating Output Current versus Ambient Temperature and Airflow
Vin(nom)

Characteristic Curves (Continued)

All test conditions are at 25°C. The figures are for DPX20-48WS3P3

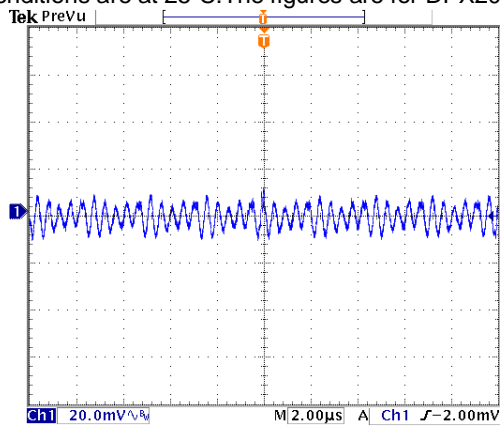

Typical Output Ripple and Noise.
Vin(nom); Full Load

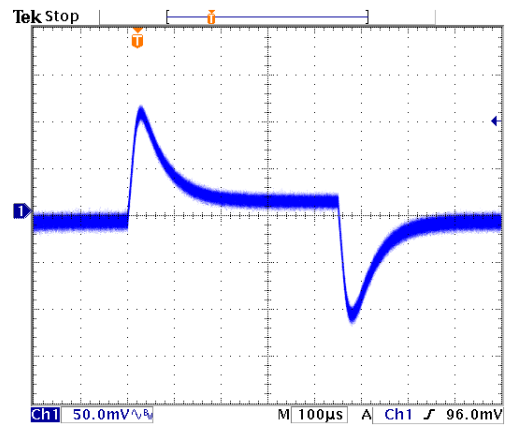

Transient Response to Dynamic Load Change from
100% to 75% to 100% of Full Load; Vin(nom)

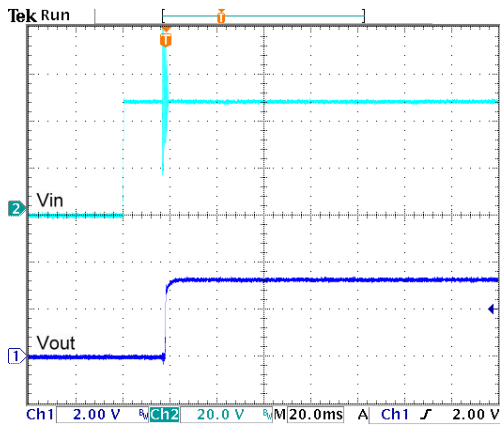

Typical Input Start-Up and Output Rise Characteristic
Vin(nom); Full Load

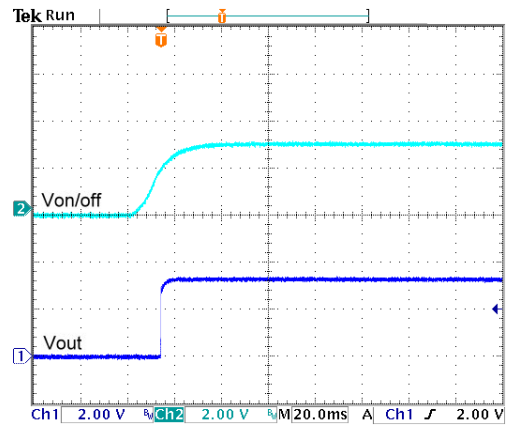

Using ON/OFF Voltage Start-Up and Output Rise Characteristic
Vin(nom); Full Load

Characteristic Curves (Continued)

All test conditions are at 25°C. The figures are for DPX20-48WS05

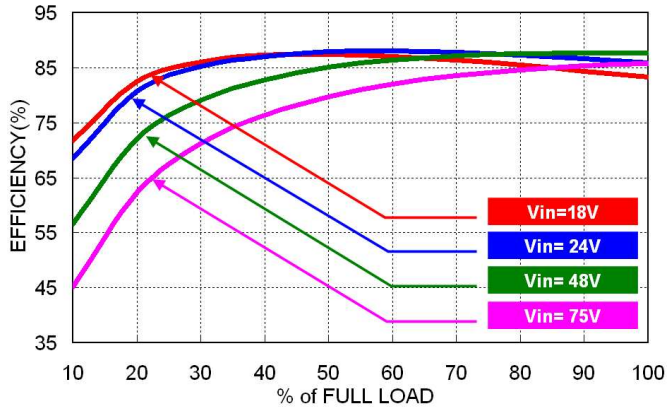

Efficiency versus Output Load

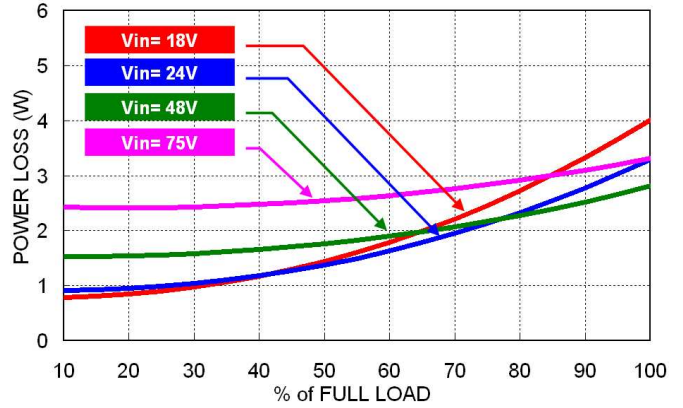

Power Dissipation versus Output Load

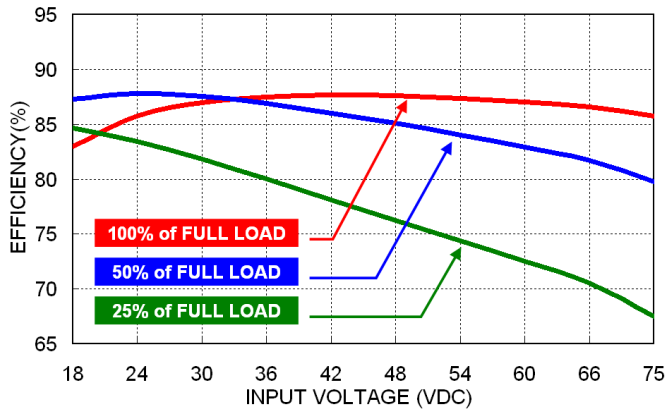

Efficiency versus Input Voltage

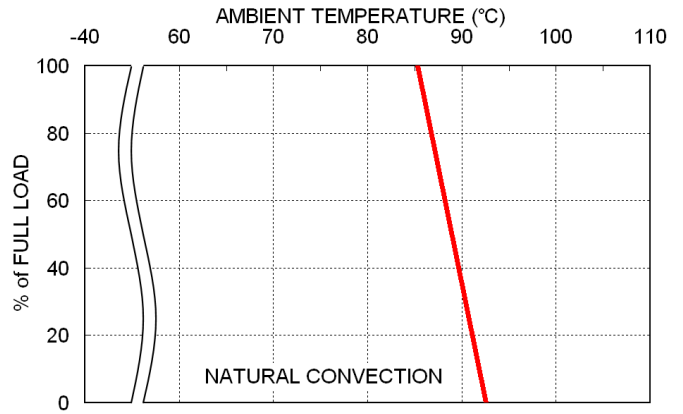

Derating Output Current versus Ambient Temperature and Airflow
Vin(nom)

Characteristic Curves (Continued)

All test conditions are at 25°C. The figures are for DPX20-48WS05

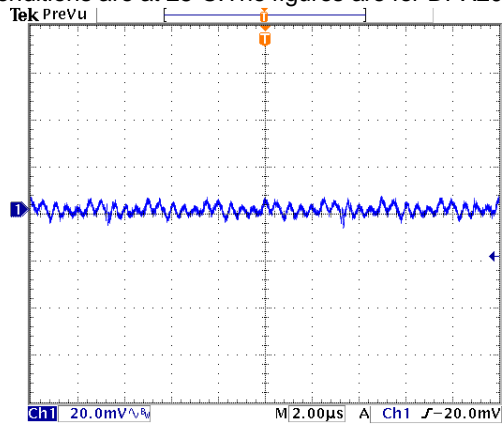

Typical Output Ripple and Noise.
Vin(nom); Full Load

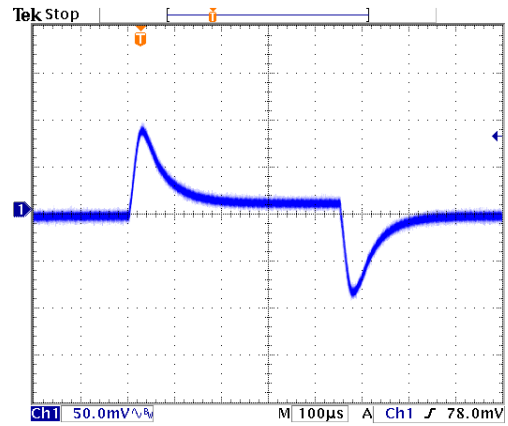

Transient Response to Dynamic Load Change from
100% to 75% to 100% of Full Load; Vin(nom)

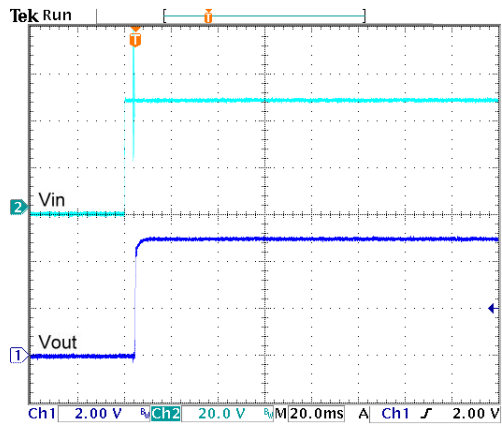

Typical Input Start-Up and Output Rise Characteristic
Vin(nom); Full Load

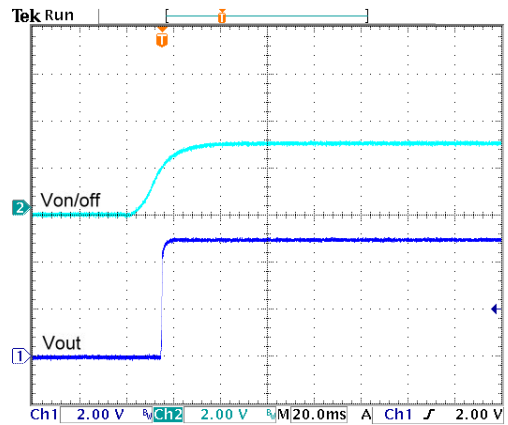

Using ON/OFF Voltage Start-Up and Output Rise Characteristic
Vin(nom); Full Load

Characteristic Curves (Continued)

All test conditions are at 25°C. The figures are for DPX20-48WS12

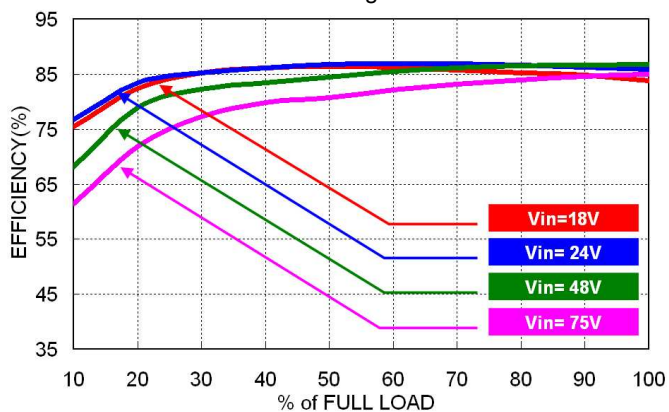

Efficiency versus Output Load

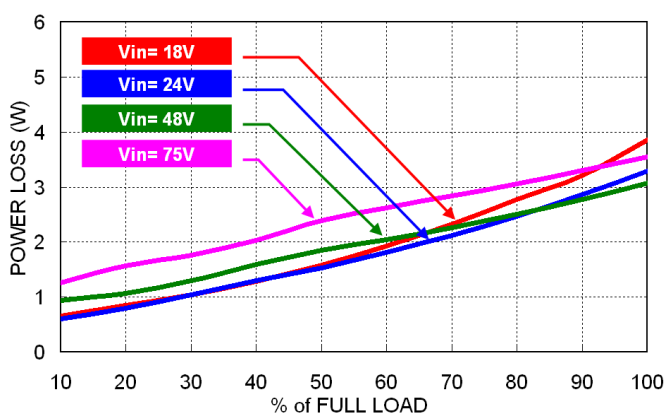

Power Dissipation versus Output Load

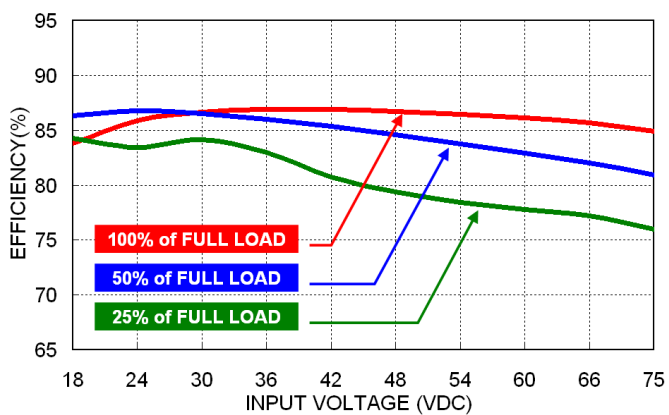

Efficiency versus Input Voltage

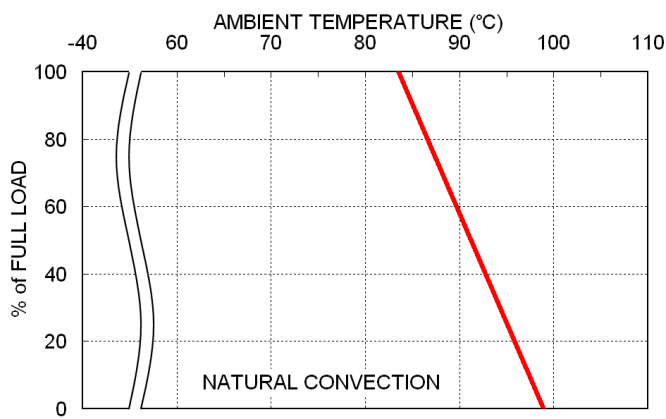

Derating Output Current versus Ambient Temperature and Airflow
Vin(nom)

Characteristic Curves (Continued)

All test conditions are at 25°C. The figures are for DPX20-48WS12

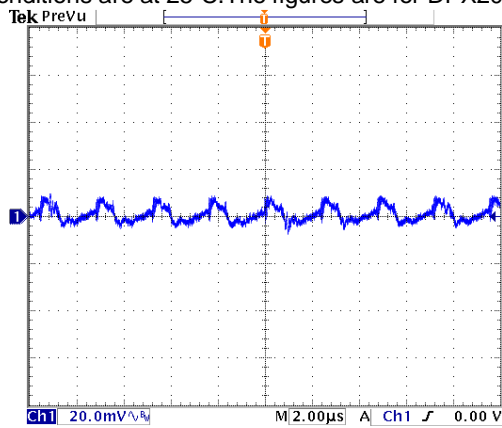

Typical Output Ripple and Noise.
Vin(nom); Full Load

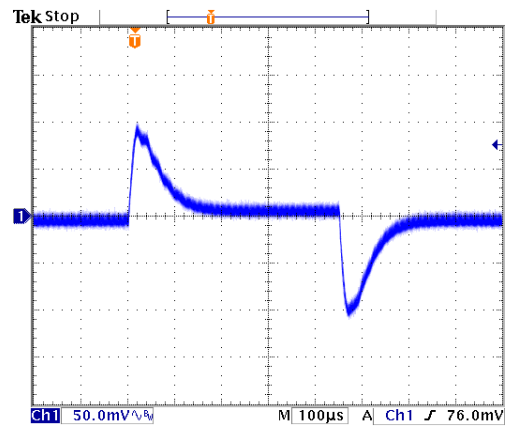

Transient Response to Dynamic Load Change from
100% to 75% to 100% of Full Load; Vin(nom)

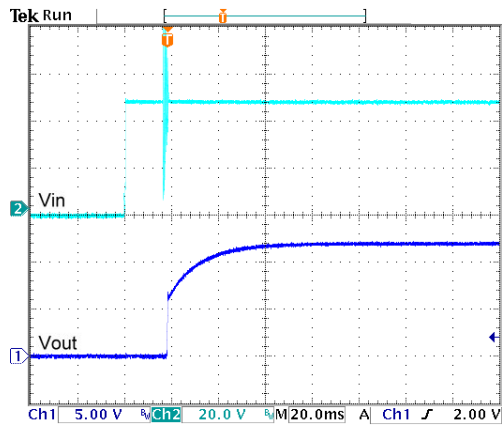

Typical Input Start-Up and Output Rise Characteristic
Vin(nom); Full Load

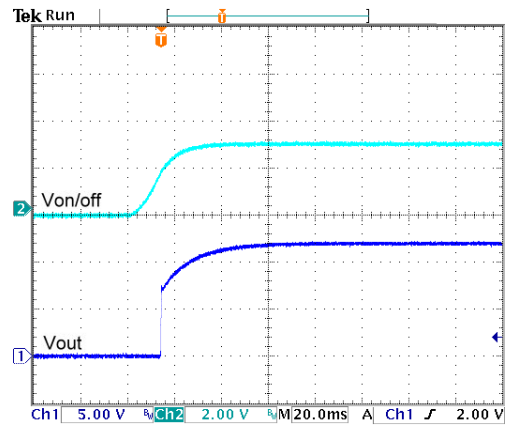

Using ON/OFF Voltage Start-Up and Output Rise Characteristic
Vin(nom); Full Load

Characteristic Curves (Continued)

All test conditions are at 25°C. The figures are for DPX20-48WS15

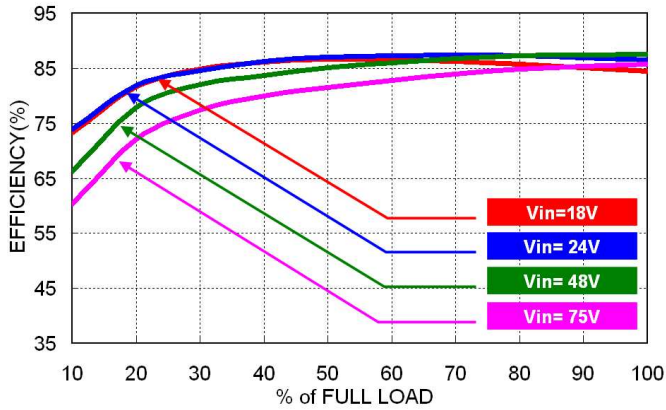

Efficiency versus Output Load

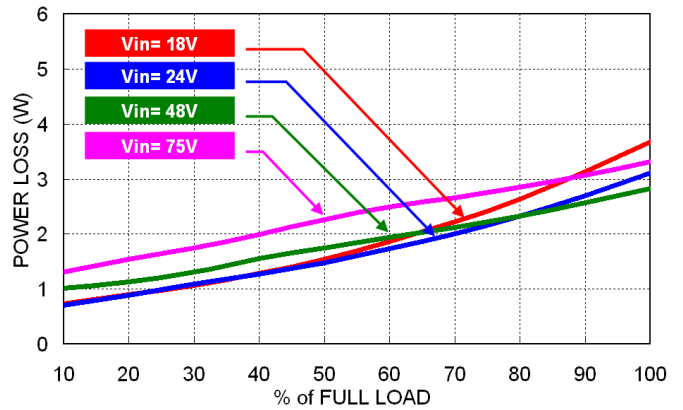

Power Dissipation versus Output Load

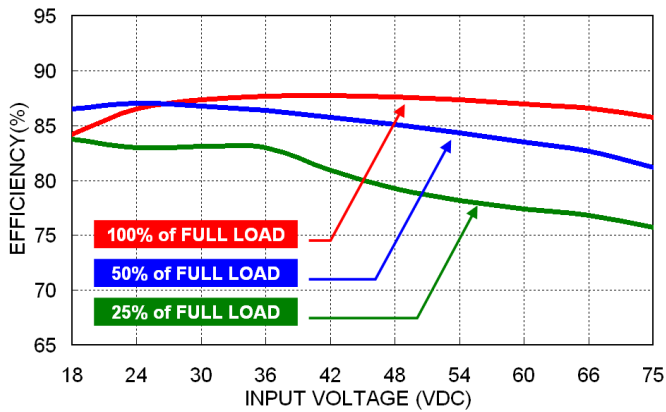

Efficiency versus Input Voltage

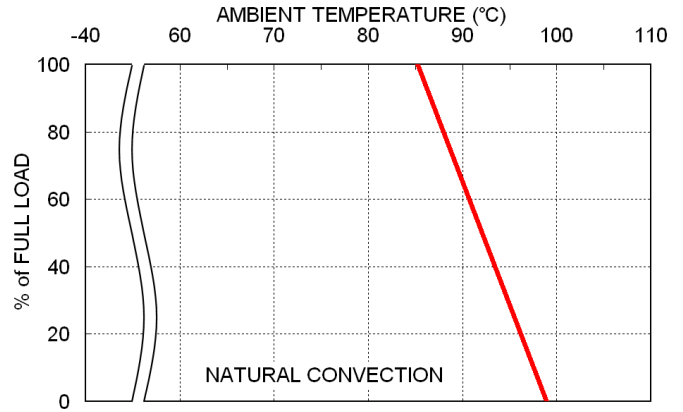

Derating Output Current versus Ambient Temperature and Airflow
Vin(nom)

Characteristic Curves (Continued)

All test conditions are at 25°C. The figures are for DPX20-48WS15

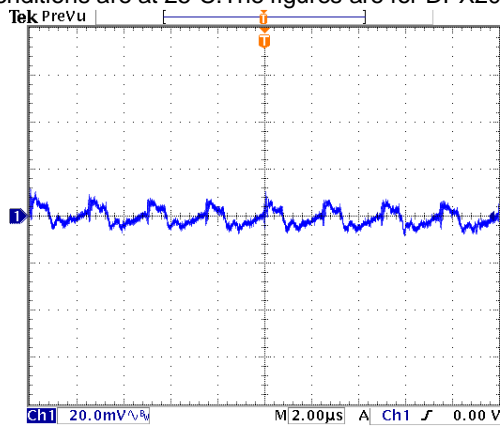

Typical Output Ripple and Noise.
Vin(nom); Full Load

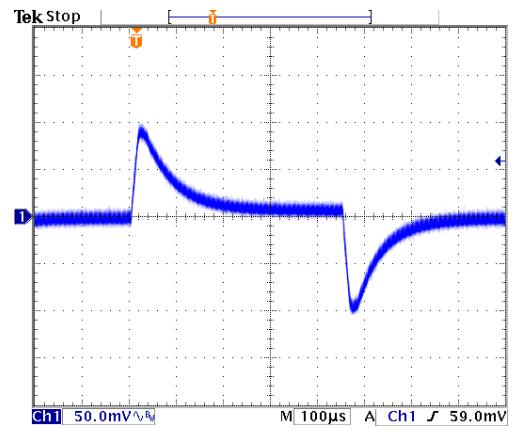

Transient Response to Dynamic Load Change from
100% to 75% to 100% of Full Load; Vin(nom)

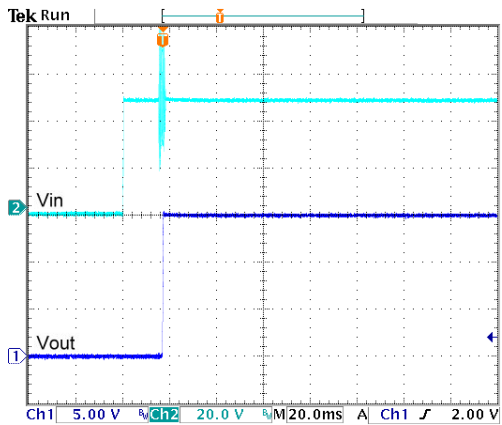

Typical Input Start-Up and Output Rise Characteristic
Vin(nom); Full Load

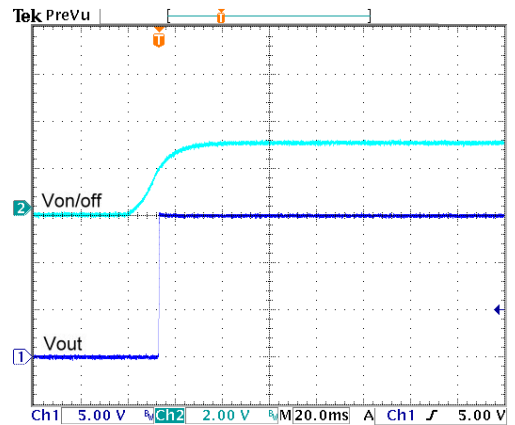

Using ON/OFF Voltage Start-Up and Output Rise Characteristic
Vin(nom); Full Load

Input Source Impedance

The power module should be connected to a low impedance input source. Highly inductive source impedance can affect the stability of the power module. The test configuration for the input reflected-ripple current measurement is shown below:

Input reflected-ripple current measurement setup

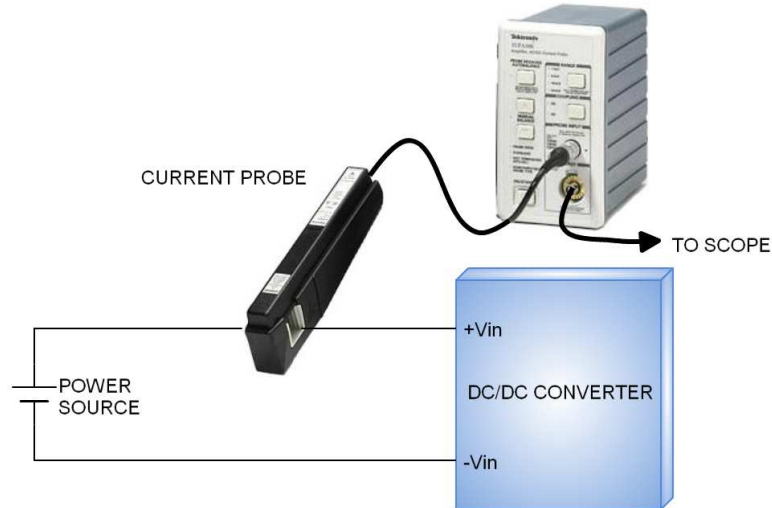

Output Over Current Protection

When excessive output currents occur in the system, circuit protection is required on all power supplies. Normally, overload current is maintained at approximately 150 percent of rated current for DPX20-xxWSxx series.

Hiccup-mode is a method of operation in a power supply whose purpose is to protect the power supply from being damaged during an over-current fault condition. It also enables the power supply to restart when the fault is removed. There are other ways of protecting the power supply when it is over-loaded, such as the maximum current limiting or current fold-back methods.

One of the problems resulting from over current is that excessive heat may be generated in power devices; especially MOSFET and Schottky diodes and the temperature of those devices may exceed their specified limits. A protection mechanism has to be used to prevent those power devices from being damaged.

The operation of hiccup is as follows. When the current sense circuit sees an over-current event, the controller shuts off the power supply for a given time and then tries to start up the power supply again. If the over-load condition has been removed, the power supply will start up and operate normally; otherwise, the controller will see another over-current event and shut off the power supply again, repeating the previous cycle. Hiccup operation has none of the drawbacks of the other two protection methods, although its circuit is more complicated because it requires a timing circuit. The excess heat due to overload lasts for only a short duration in the hiccup cycle, hence the junction temperature of the power devices is much lower.

The hiccup operation can be done in various ways. For example, one can start hiccup operation any time an over-current event is detected; or prohibit hiccup during a designated start-up interval (usually a few milliseconds). The reason for the latter operation is that during start-up, the power supply needs to provide extra current to charge up the output capacitor. Thus the current demand during start-up is usually larger than during normal operation and it is easier for an over-current event to occur. If the power supply starts to hiccup once there is an over-current, it might never start up successfully. Hiccup mode protection will give the best protection for a power supply against over current situations, since it will limit the average current to the load at a low level, so reducing power dissipation and case temperature in the power devices.

Output Short Circuit Protection

Continuous and auto-recovery mode.

During an output short circuit, the converter shuts down. The average current during this condition will be very low.

Output Over Voltage Protection

The output over-voltage protection consists of output Zener diode that monitors the voltage on the output terminals. If the voltage on the output terminals exceeds the over-voltage protection threshold, then the Zener diode clamps the output voltage.

Remote On/off Control

The Ctrl Pin is used to turn the DC/DC power module on and off. The user must use a switch to control the logic voltage (high or low) level of the pin referenced to $-V_{in}$. The switch can be an open collector transistor, FET, or Photo-Coupler. The switch must be capable of sinking up to 1 mA at low-level logic voltage. A High-level logic of the Ctrl pin signal should be limited to a maximum voltage of 12V and a maximum current of 0.5 mA.

Remote ON/OFF Implementation

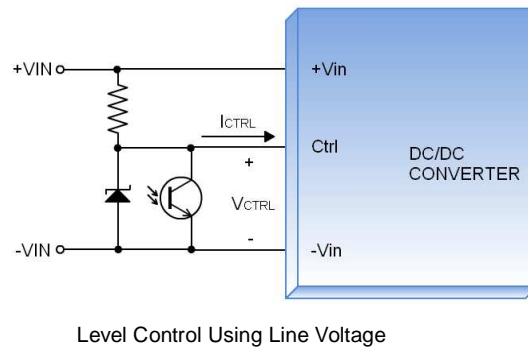
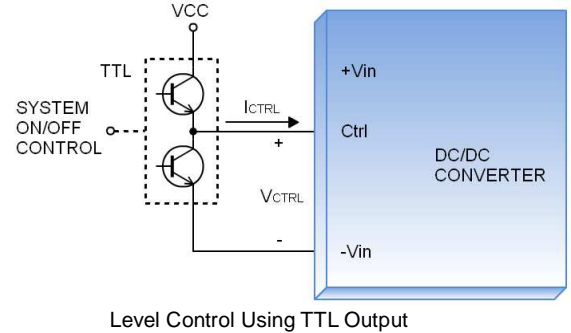
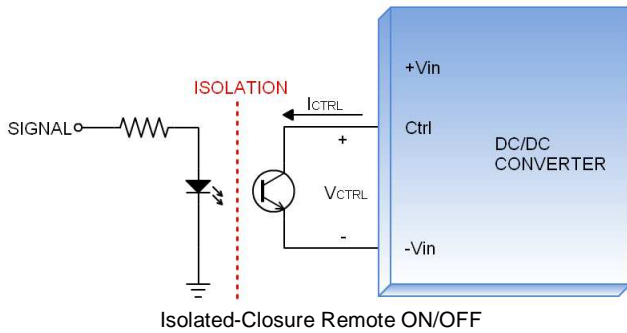

There are two remote control options available, positive logic (optional) and negative logic (optional).

a. The positive logic structure turns on the DC/DC module when the Ctrl pin is at a high-logic level and turns the module off using a low-logic level.

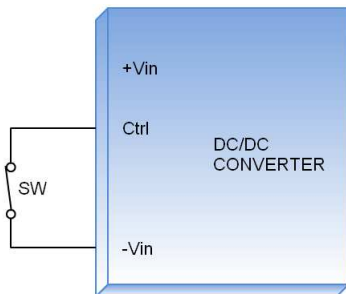

When DPX20-xxWSxx-P module is turned off using a Low-logic level

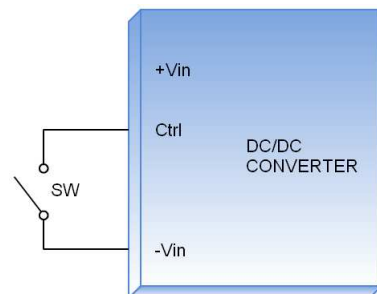

When DPX20-xxWSxx-P module is turned on using a High-logic level

b. The negative logic structure turns on the DC/DC module when the Ctrl pin is at a low-logic level and turns the module off when using a high-logic level.

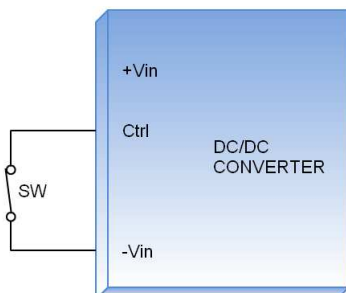

When DPX20-xxWSxx-N module is turned on using a Low-logic level

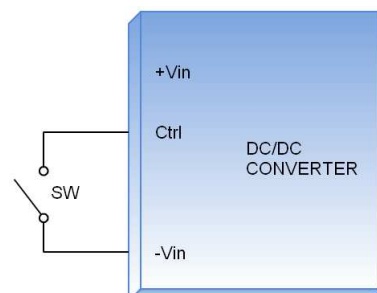

When DPX20-xxWSxx-N module is turned off using a High-logic level

EMS Considerations

The DPX20-xxWSxx series can meet Fast Transient EN61000-4-4 and Surge EN61000-4-5 performance criteria A. Please see the following schematic:

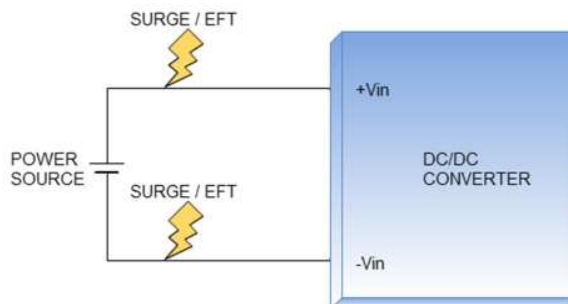

Mechanical Data

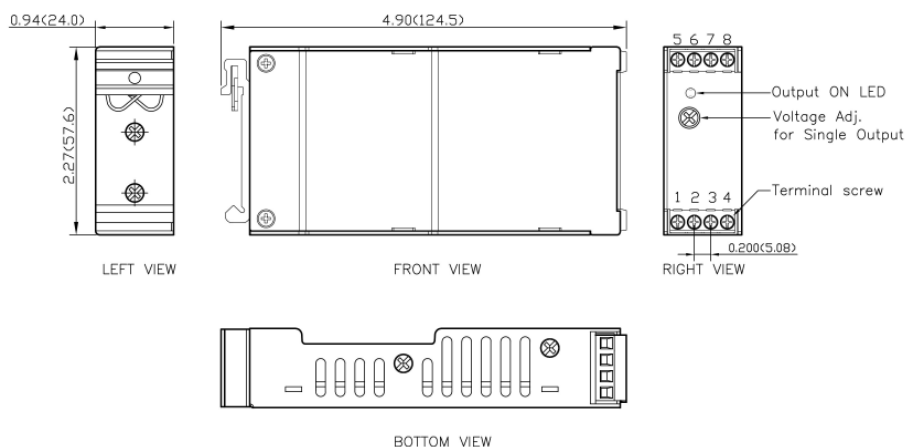

PINOUT

PIN	FUNCTION
1	Ctrl
2	-Vin
3	-Vin
4	+Vin
5	NC
6	-Vout
7	+Vout
8	NC

* NC : No Connection

* Screw terminals—wire range from 14 to 18 AWG

1. All dimensions in inch (mm)
2. Tolerance : X.XX±0.02 (X.X±0.5)
X.XXX±0.01 (X.XX±0.25)
3. Terminal screw locked torque :
MAX 2.5kgf—cm (0.25N—m)

Packaging Information

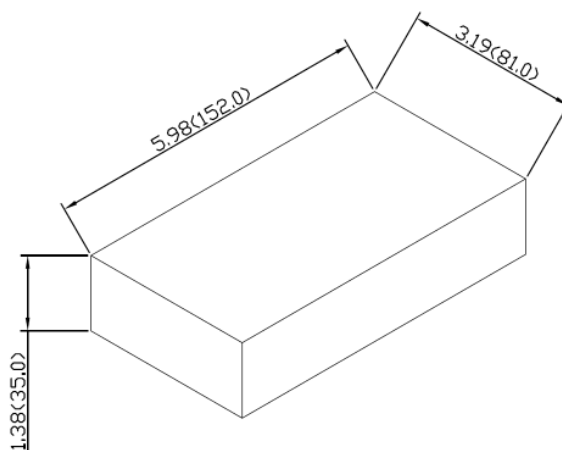
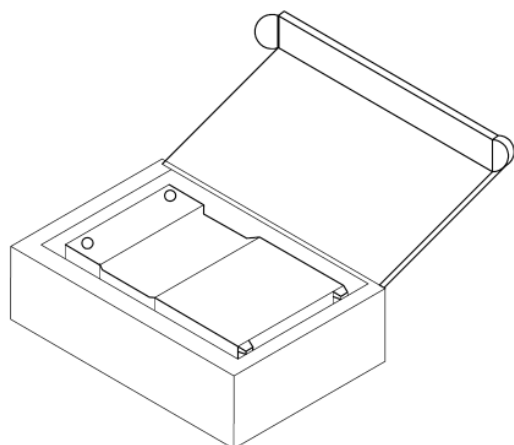

1PCS / BOX
All dimensions in mm

Part Number Structure

DPX20	-	48W	S	05	-	X
Series Name		Input Voltage (VDC)	Output Quantity	Output Voltage (VDC)		Remote Control Option
		24: 9.5~36 48: 18~75	S: Single	3P3: 3.3 05: 5 12: 12 15: 15		P: Positive logic N: Negative logic

Model Number	Input Range VDC	Output Voltage VDC	Output Current @ Full Load A	Input Current @ No Load mA	Efficiency %	Maximum Capacitor Load μF
DPX20-24WS3P3	9.5 ~ 36	3.3	5.5	52	83	18000
DPX20-24WS05	9.5 ~ 36	5	4	67	86	9600
DPX20-24WS12	9.5 ~ 36	12	1.67	26	84	1650
DPX20-24WS15	9.5 ~ 36	15	1.33	27	84	1050
DPX20-48WS3P3	18 ~ 75	3.3	5.5	37	83	18000
DPX20-48WS05	18 ~ 75	5	4	37	86	9600
DPX20-48WS12	18 ~ 75	12	1.67	18	85	1650
DPX20-48WS15	18 ~ 75	15	1.33	18	85	1050

MTBF and Reliability

The MTBF for DPX20-xxWSxx series of DC/DC converters has been calculated using MIL-HDBK-217F @ full load, operating temperature at 25°C. The resulting figure for MTBF is 1.619×10^6 hours.