

DPX15-xxWDxx Dual Output: DC-DC Converter Module

9.5 ~ 36VDC, 18 ~ 75VDC input; ± 5 to ± 15 VDC Dual Output;
15 Watts Output Power



CE MARKED
SAFETY MEETS:

UL60950-1
EN60950-1
IEC60950-1

FEATURES

- NO MINIMUM LOAD REQUIRED
- 1600VDC INPUT TO OUTPUT ISOLATION
- SCREW TERMINALS FOR INPUT AND OUTPUT CONNECTIONS
- RELIABLE SNAP-ON FOR DIN RAIL TS-35/7.5 OR TS-35/15
- CASE PROTECTION MEETS IP20(IEC60529)
- INPUT FUSE PROTECTION
- INPUT REVERSE POLARITY PROTECTION
- INPUT IN-RUSH CURRENT LIMIT CIRCUIT
- OUTPUT DC-OK INDICATOR
- 4:1 WIDE INPUT VOLTAGE RANGE
- FIXED SWITCHING FREQUENCY
- INPUT UNDER-VOLTAGE PROTECTION
- OUTPUT OVER-VOLTAGE PROTECTION
- OVER-CURRENT PROTECTION
- OUTPUT SHORT CIRCUIT PROTECTION
- MEETS EN55022 CLASS B
- REMOTE ON/OFF
- COMPLIANT TO RoHS II & REACH

APPLICATIONS

- COMMUNICATION SYSTEMS
- INDUSTRY CONTROL SYSTEMS
- FACTORY AUTOMATION EQUIPMENT
- SEMICONDUCTOR EQUIPMENT

OPTIONS

- REMOTE ON/OFF

GENERAL DESCRIPTION

The DPX15-xxWDxx series was designed for applications requiring din rail mountable DC-DC converters. Easy installation is provided with snap-on mounting to the DIN-rail. Internal circuits provide protection against reverse input voltage, input in-rush current, output short-circuit, output over-current, and output over-voltage conditions. A green LED at the front panel indicates the status of the output voltage.

Contents

Output Specifications	3
Input Specifications	4
General Specifications	5
Environmental Specifications	5
EMC Characteristics	5
Characteristic Curves	
DPX15-24WD05	6
DPX15-24WD12	8
DPX15-24WD15	10
DPX15-48WD05	12
DPX15-48WD12	14
DPX15-48WD15	16
Input Source Impedance	18
Output Over Current Protection	18
Output Short Circuit Protection	18
Output Over Voltage Protection	18
Remote On/off Control	19
EMS Considerations	20
Mechanical Data	20
Packaging Information	20
Part Number Structure	21
MTBF and Reliability	21

Output Specifications

Parameter	Model	Min	Typ	Max	Unit
Output Voltage (Vin(nom); Full Load; Ta=25°C)	xxWD05 xxWD12 xxWD15	4.94 11.856 14.82	5 12 15	5.06 12.144 15.18	VDC
Output Regulation Line (Vin(min) to Vin(max); Full Load) Load (0% to 100% of Full Load)	All	-0.5 -1.5		+0.5 +1.5	%
Output Ripple and Noise Peak to Peak (20MHz Bandwidth)	All		75	100	mVp-p
Cross Regulation (Asymmetrical Load 25% / 100% of Full Load)	All	-5.0		+5.0	% of Vout
Temperature Coefficient	All	-0.02		+0.02	%/°C
Output Voltage Overshoot (Vin(min) to Vin(max) Full Load; Ta=25°C)	All		0	5	% of Vout
Dynamic Load Response (Vin(nom); Ta=25°C) Load step change from 75% to 100% or 100 to 75% of Full Load Peak Deviation Settling Time (Vout 10% peak deviation)	All All		250 250		mV µs
Output Current	xxWD05 xxWD12 xxWD15	0 0 0		±1500 ±625 ±500	mA
Output Capacitance Load	xxWD05 xxWD12 xxWD15			±3600 ±625 ±400	µF
Output Over Voltage Protection (see page 18) (Zener diode clamp)	xxWD05 xxWD12 xxWD15		6.2 15 18		VDC
Output Indicator	All	Green LED			
Output Over Current Protection (see page 18) (% of Iout rated; Hiccup mode)	All		150		% of FL
Output Short Circuit Protection (see page 18)	All	Continuous, automatic recovery			

Input Specifications

Parameter	Model	Min	Typ	Max	Unit
Operating Input Voltage					
Continuous	24WDxx 48WDxx	9.5 18	24 48	36 75	VDC
Transient (100ms,max)	24WDxx 48WDxx			50 100	
Input Standby Current (Vin(nom); No Load)	24WD05 24WD12 24WD15 48WD05 48WD12 48WD15		57 35 35 37 20 20		mA
Under Voltage Lockout Turn-on Threshold	24WDxx 48WDxx			9.5 18	VDC
Under Voltage Lockout Turn-off Threshold	24WDxx 48WDxx		7.5 15		VDC
Input Reflected Ripple Current (see page 18) (Vin(nom); Full Load)	All		10		mAp-p
Start Up Time (Vin(nom) and constant resistive load)	All		100		ms
Remote ON/OFF Control (see page 19) (The Ctrl pin voltage is referenced to negative input)					
Positive Logic (Optional) On/Off pin High Voltage (Remote ON) On/Off pin Low Voltage (Remote OFF)	xxWDxx- P			Open or 3 ~ 12VDC Short or 0 ~ 1.2VDC	
Negative Logic (Optional) On/Off pin Low Voltage (Remote ON) On/Off pin High Voltage (Remote OFF)	xxWDxx- N			Short or 0 ~ 1.2VDC Open or 3 ~ 12VDC	
Input Current of Remote Control Pin		-0.5		0.5	mA
Remote Off State Input Current			2.5		mA
Input Fuse (Slow Blow)	24WDxx 48WDxx		6 4		A
In-rush Current	All		15		A

General Specifications

Parameter	Model	Min	Typ	Max	Unit
Efficiency (Vin(nom); Full Load; Ta=25°C)	24WD05		85		%
	24WD12		86		
	24WD15		86		
	48WD05		86		
	48WD12		86		
	48WD15		86		
Isolation Voltage (1 minute) Input to Output Input to Chassis, Output to Chassis	All	1600			VDC
		1600			
Isolation Resistance (500VDC)	All	1			GΩ
Isolation Capacitance	All			4000	pF
Switching Frequency	All	360	400	440	kHz
Safety Meets	All	IEC60950-1, UL60950-1, EN60950-1			
Weight	All	147.5			g
MTBF (see page 21) MIL-HDBK-217F Ta=25°C, Full load	All	1.681 x 10 ⁶			hours
Chassis Material	All	Aluminum			

Environmental Specifications

Parameter	Model	Min	Typ	Max	Unit
Operating Ambient Temperature	Without derating	-40		+85	°C
	With derating	+85		+93	
Storage Temperature	All	-40		105	°C
Relative Humidity	All	5		95	% RH
Thermal Shock	All	MIL-STD-810F			
Vibration	All	IEC60068-2-6			

EMC Characteristics

Characteristic	Standard	Condition	Level
EMI	EN55022	Module stand-alone	Class B
ESD	EN61000-4-2	Air	±8kV
		Contact	±6kV
Radiated Immunity	EN61000-4-3	10V/m	Perf. Criteria A
Fast Transient (see page 28)	EN61000-4-4	±2kV	Perf. Criteria A
Surge (see page 28)	EN61000-4-5	±0.5kV	Perf. Criteria A
Conducted Immunity	EN61000-4-6	10V r.m.s	Perf. Criteria A
Power Frequency Magnetic Field	EN61000-4-8	100A/m continuous; 1000A/m 1 second	Perf. Criteria A

Characteristic Curves

All test conditions are at 25°C. The figures are for DPX15-24WD05

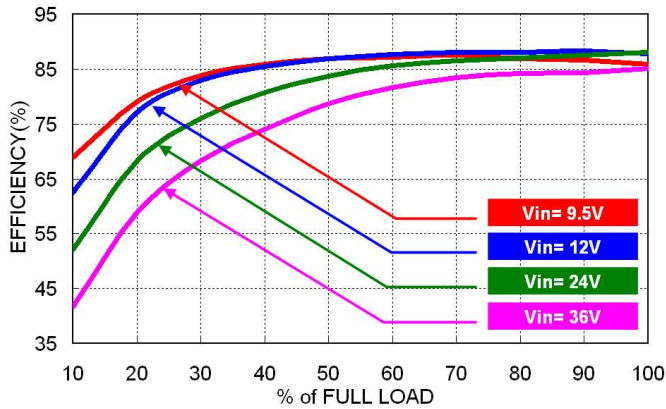

Efficiency versus Output Load

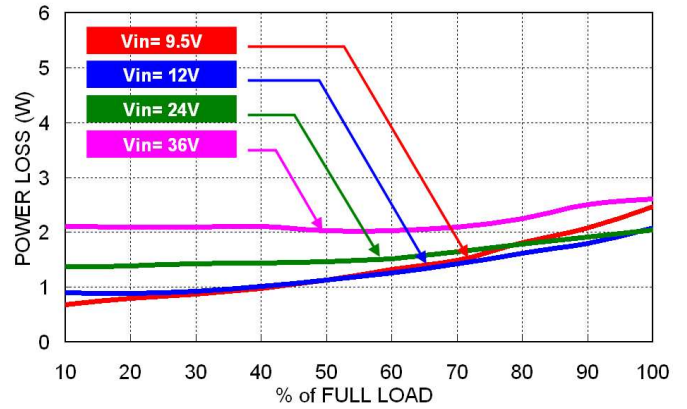

Power Dissipation versus Output Load

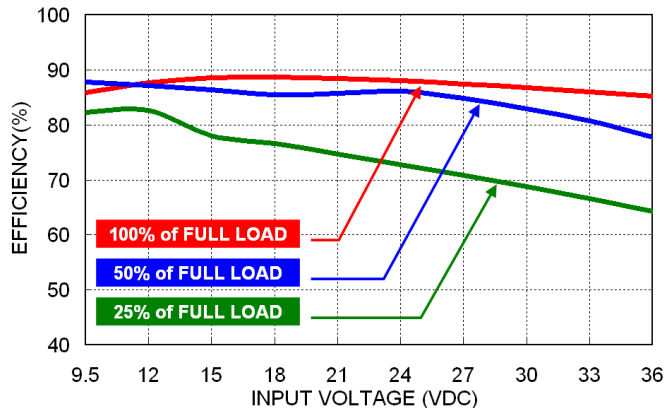

Efficiency versus Input Voltage

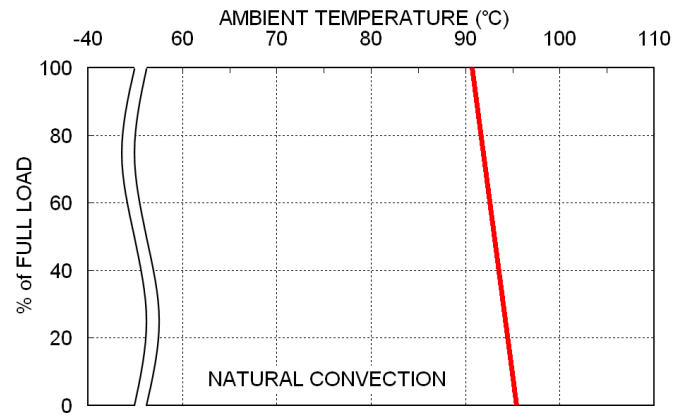

Derating Output Current versus Ambient Temperature and Airflow
Vin(nom)

Characteristic Curves (Continued)

All test conditions are at 25°C. The figures are for DPX15-24WD05

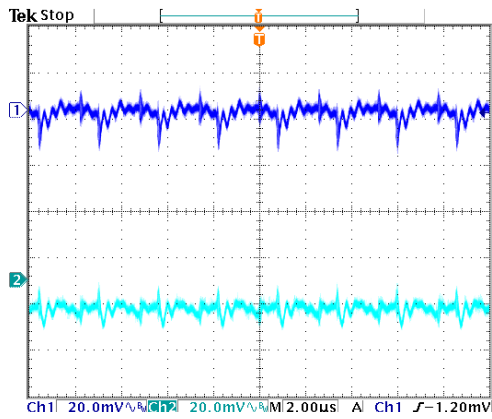

Typical Output Ripple and Noise.
Vin(nom); Full Load

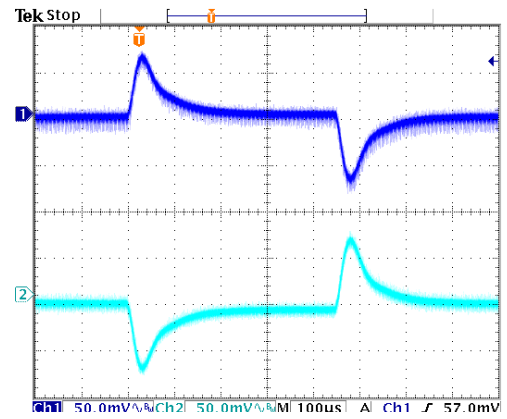

Transient Response to Dynamic Load Change from
100% to 75% to 100% of Full Load; Vin(nom)

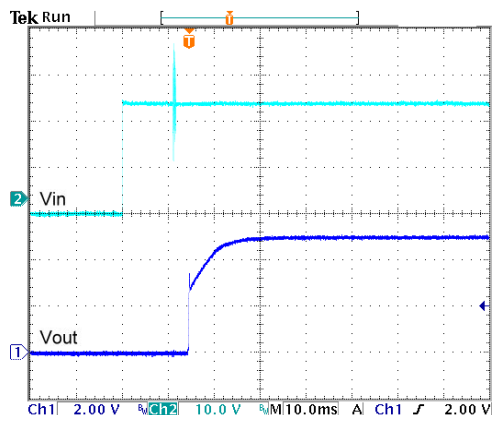

Typical Input Start-Up and Output Rise Characteristic
Vin(nom); Full Load

Characteristic Curves (Continued)

All test conditions are at 25°C. The figures are for DPX15-24WD12

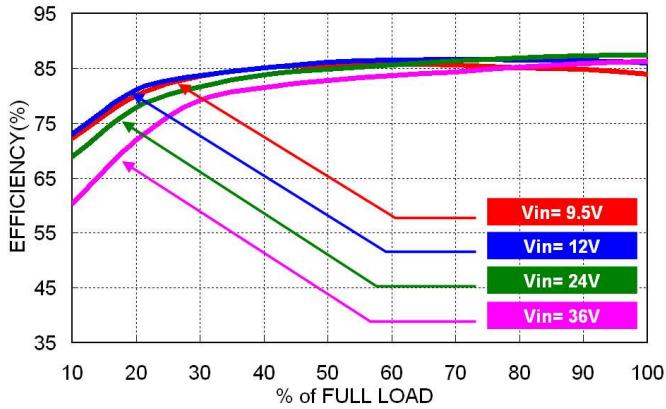

Efficiency versus Output Load

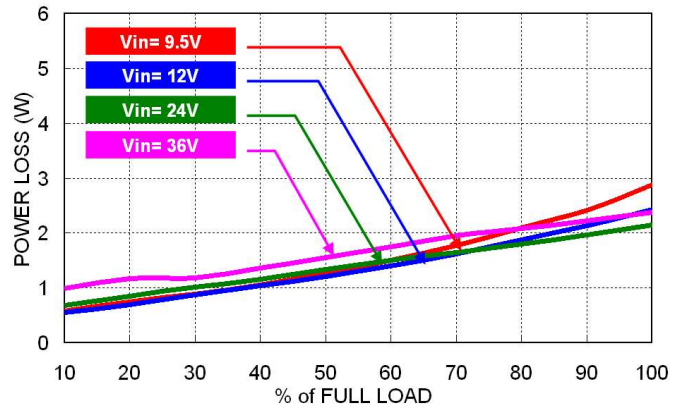

Power Dissipation versus Output Load

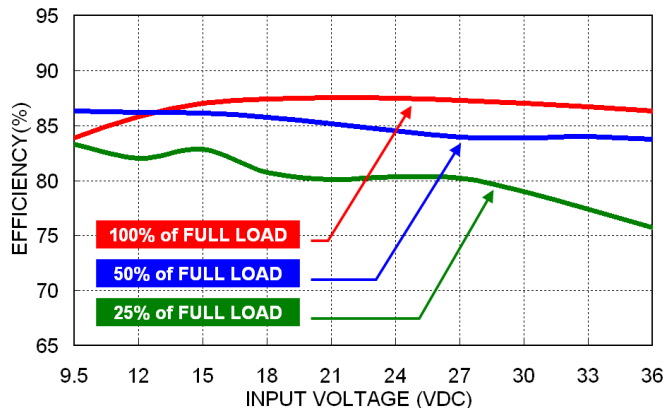

Efficiency versus Input Voltage

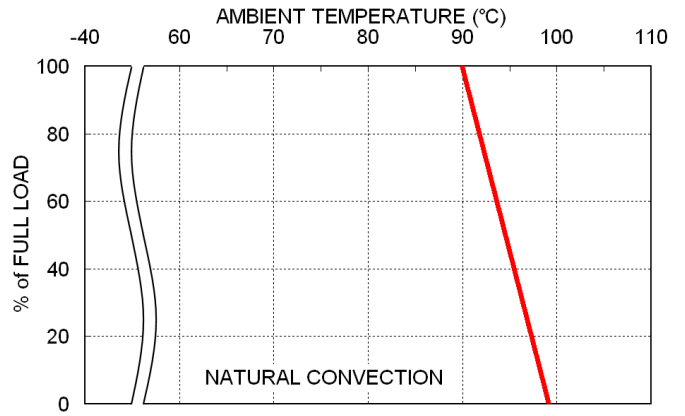

Derating Output Current versus Ambient Temperature and Airflow
Vin(nom)

Characteristic Curves (Continued)

All test conditions are at 25°C. The figures are for DPX15-24WD12

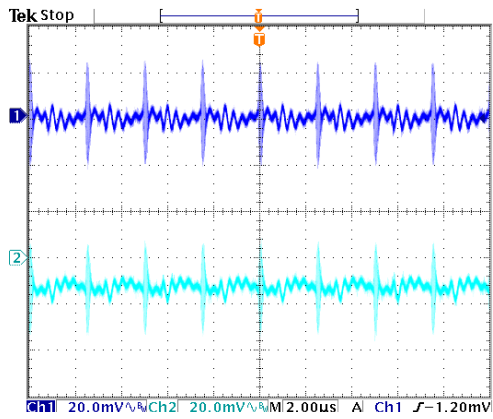

Typical Output Ripple and Noise.
Vin(nom); Full Load

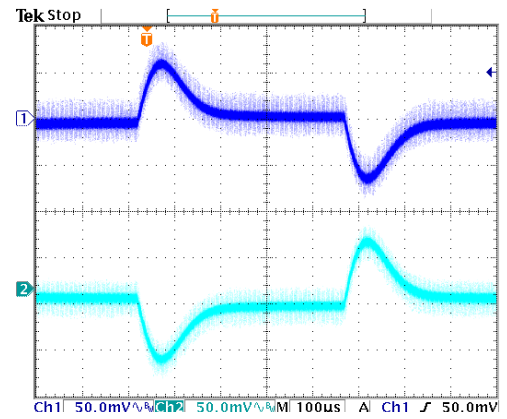

Transient Response to Dynamic Load Change from
100% to 75% to 100% of Full Load; Vin(nom)

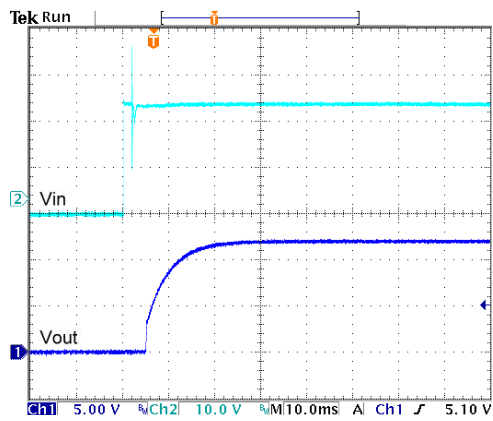

Typical Input Start-Up and Output Rise Characteristic
Vin(nom); Full Load

Characteristic Curves (Continued)

All test conditions are at 25°C. The figures are for DPX15-24WD15

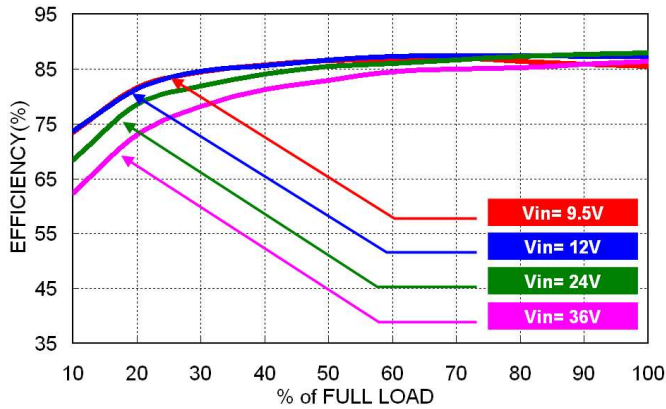

Efficiency versus Output Load

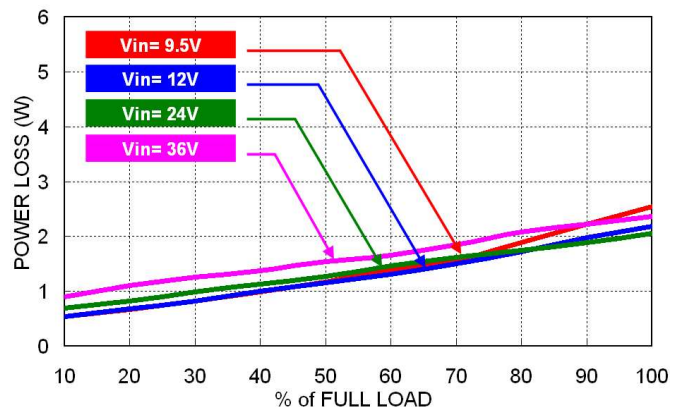

Power Dissipation versus Output Load

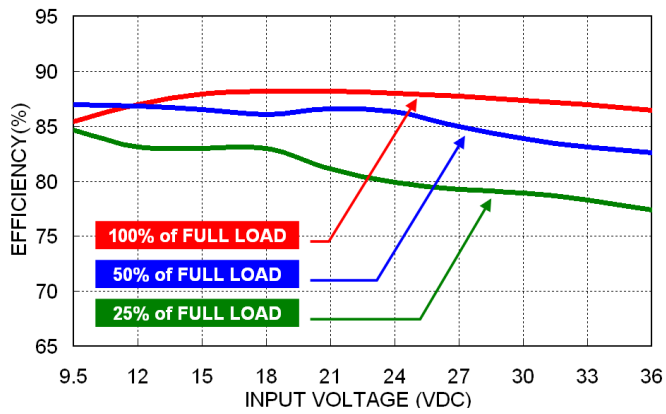

Efficiency versus Input Voltage

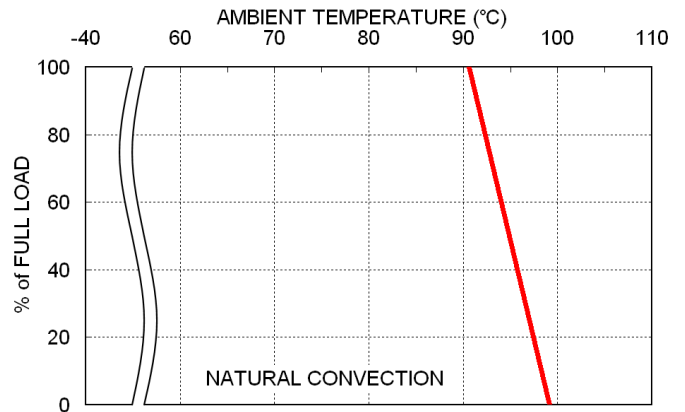

Derating Output Current versus Ambient Temperature and Airflow
Vin(nom)

Characteristic Curves (Continued)

All test conditions are at 25°C. The figures are for DPX15-24WD15

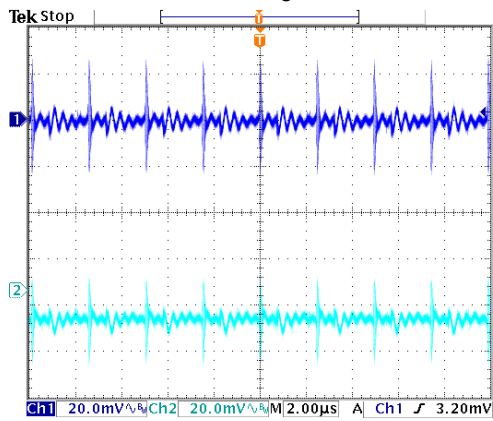

Typical Output Ripple and Noise.
Vin(nom); Full Load

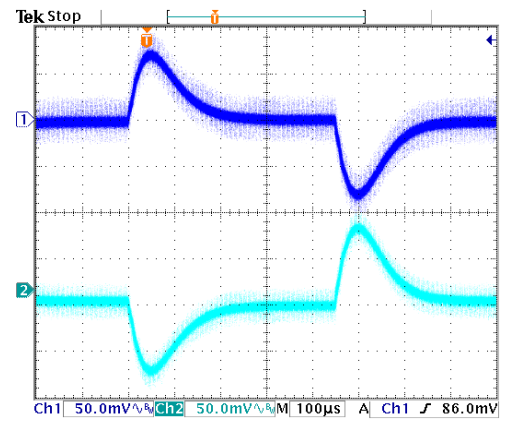

Transient Response to Dynamic Load Change from
100% to 75% to 100% of Full Load; Vin(nom)

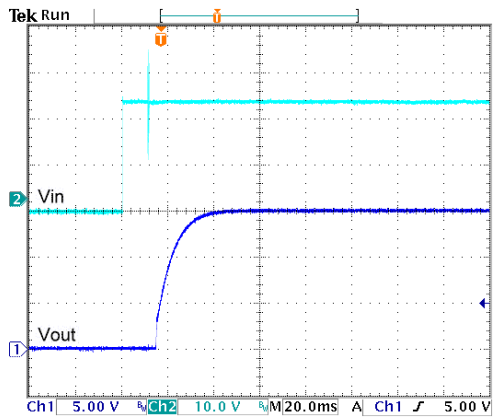

Typical Input Start-Up and Output Rise Characteristic
Vin(nom); Full Load

Characteristic Curves (Continued)

All test conditions are at 25°C. The figures are for DPX15-48WD05

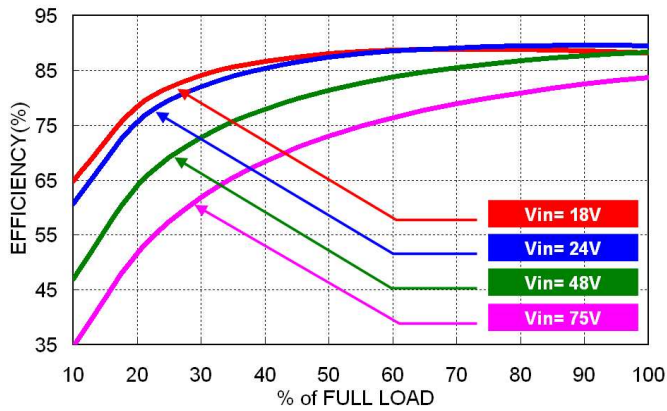

Efficiency versus Output Load

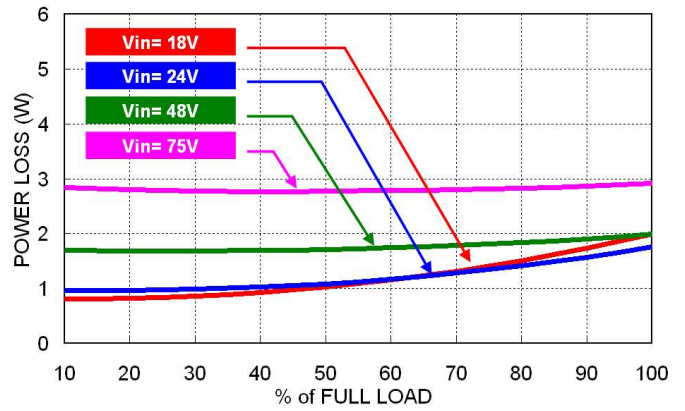

Power Dissipation versus Output Load

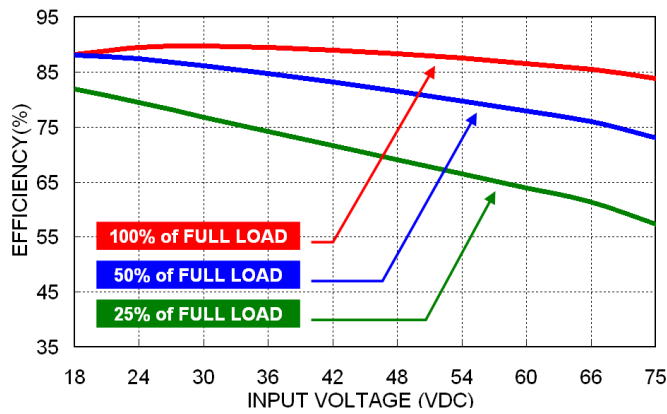

Efficiency versus Input Voltage

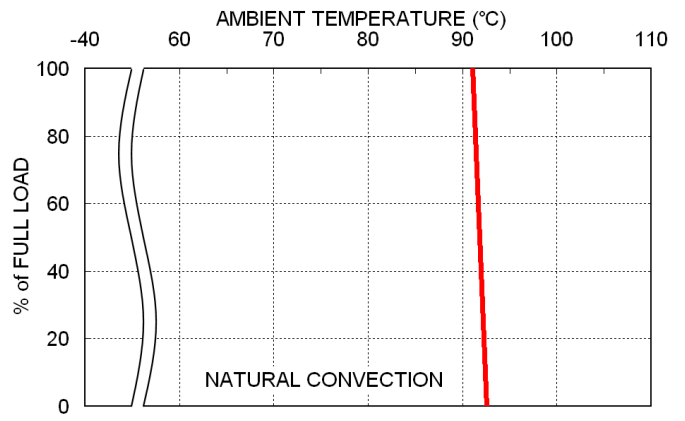

Derating Output Current versus Ambient Temperature and Airflow
Vin(nom)

Characteristic Curves (Continued)

All test conditions are at 25°C. The figures are for DPX15-48WD05

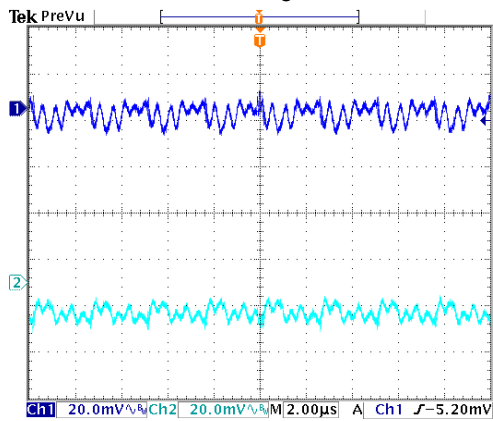

Typical Output Ripple and Noise.
Vin(nom); Full Load

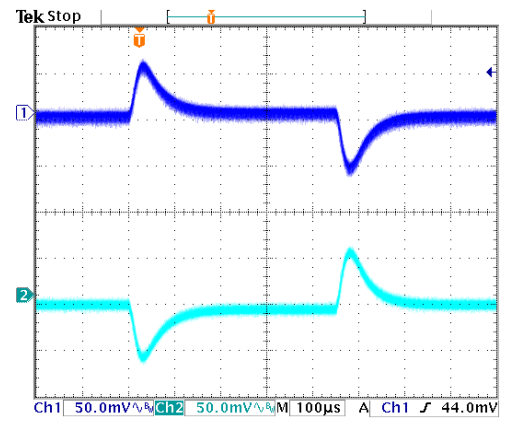

Transient Response to Dynamic Load Change from
100% to 75% to 100% of Full Load; Vin(nom)

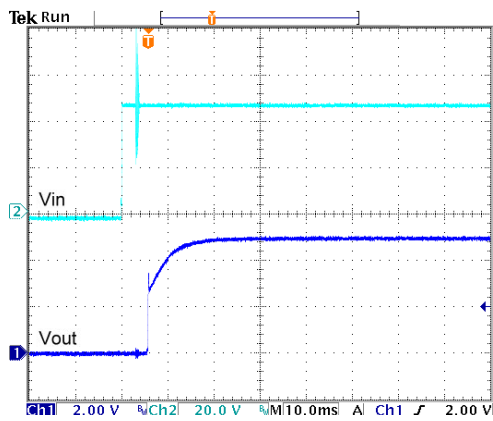

Typical Input Start-Up and Output Rise Characteristic
Vin(nom); Full Load

Characteristic Curves (Continued)

All test conditions are at 25°C. The figures are for DPX15-48WD12

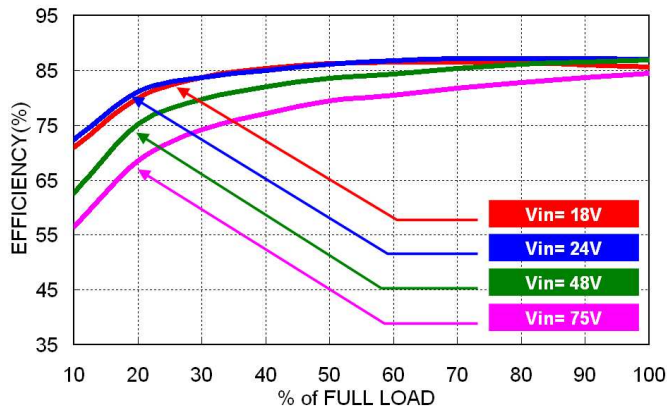

Efficiency versus Output Load

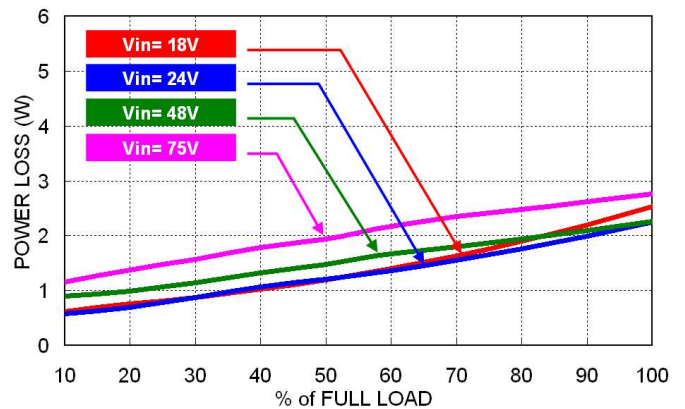

Power Dissipation versus Output Load

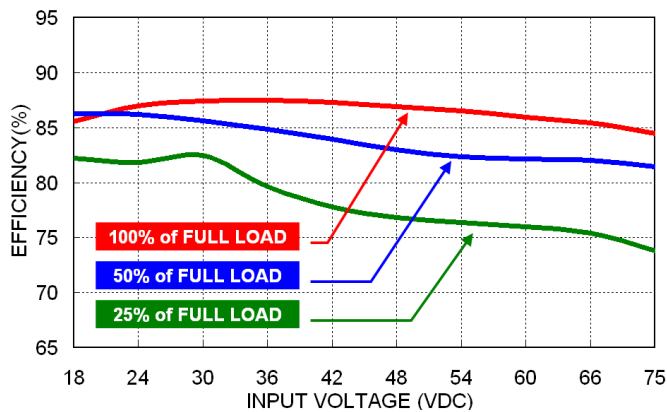

Efficiency versus Input Voltage

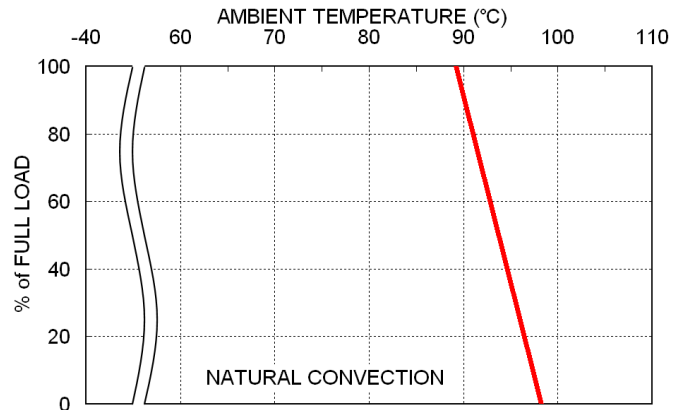

Derating Output Current versus Ambient Temperature and Airflow
Vin(nom)

Characteristic Curves (Continued)

All test conditions are at 25°C. The figures are for DPX15-48WD12

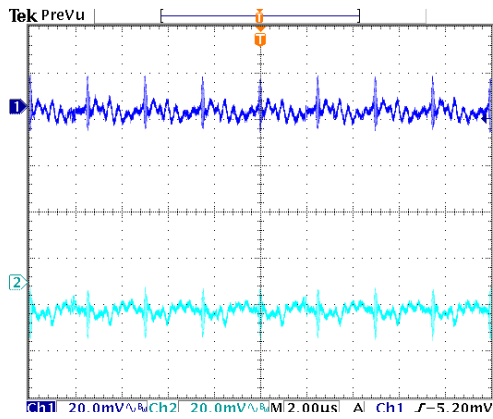

Typical Output Ripple and Noise.
Vin(nom); Full Load

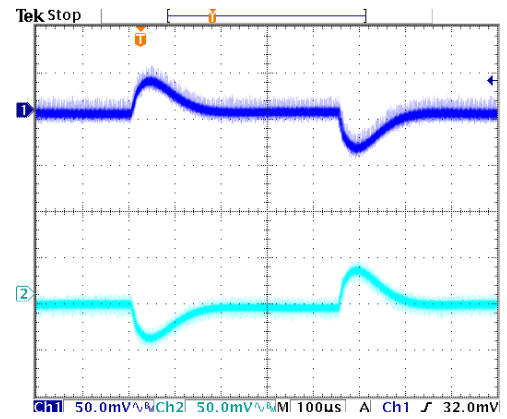

Transient Response to Dynamic Load Change from
100% to 75% to 100% of Full Load; Vin(nom)

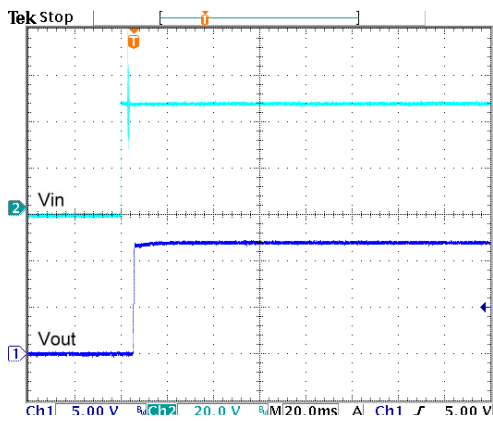

Typical Input Start-Up and Output Rise Characteristic
Vin(nom); Full Load

Characteristic Curves (Continued)

All test conditions are at 25°C. The figures are for DPX15-48WD15

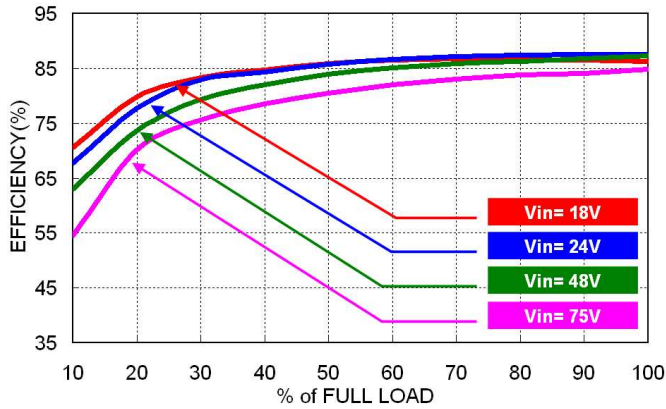

Efficiency versus Output Load

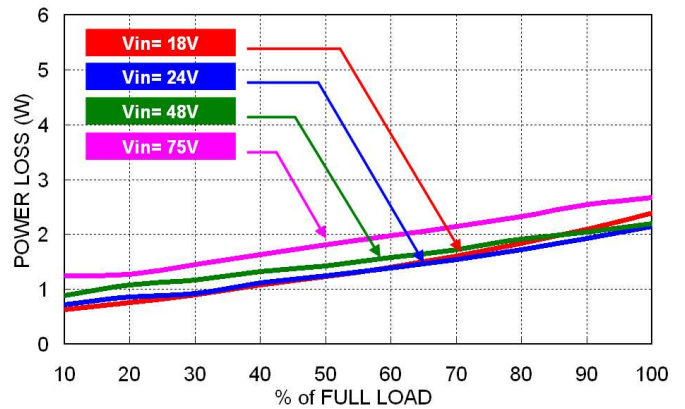

Power Dissipation versus Output Load

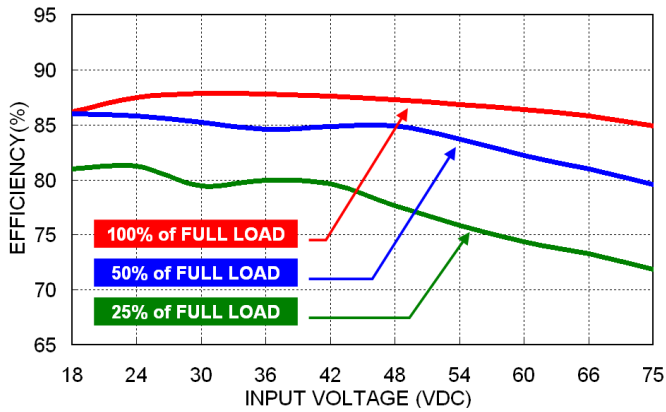

Efficiency versus Input Voltage

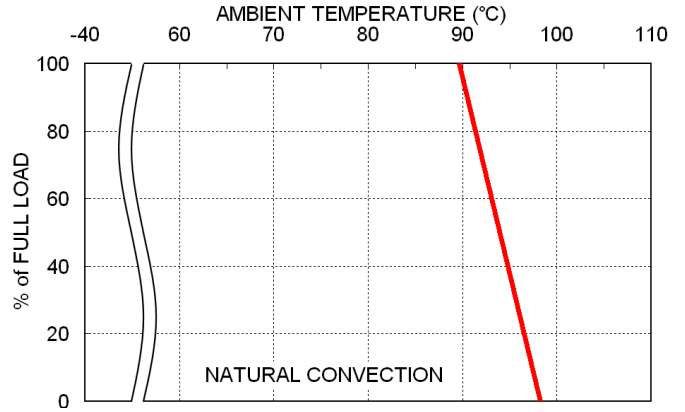

Derating Output Current versus Ambient Temperature and Airflow
Vin(nom)

Characteristic Curves (Continued)

All test conditions are at 25°C. The figures are for DPX15-48WD15

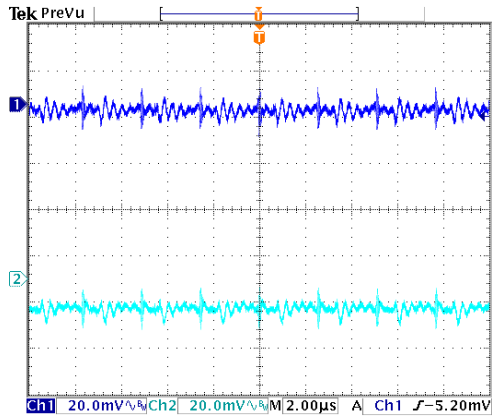

Typical Output Ripple and Noise.
Vin(nom); Full Load

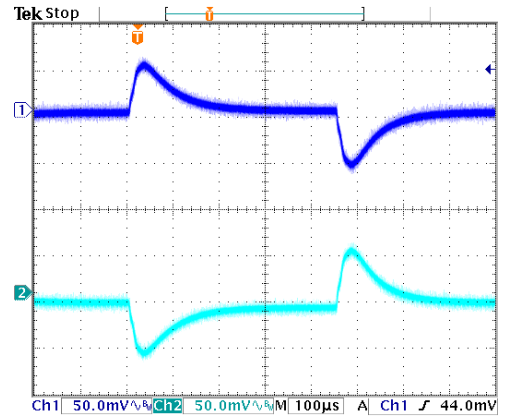

Transient Response to Dynamic Load Change from 100% to 75% to 100% of Full Load; Vin(nom)

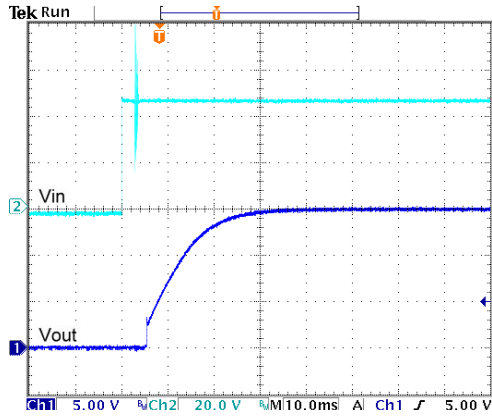

Typical Input Start-Up and Output Rise Characteristic
Vin(nom); Full Load

Input Source Impedance

The power module should be connected to a low impedance input source. Highly inductive source impedance can affect the stability of the power module. The test configuration for the input reflected-ripple current measurement is shown below:

Input reflected-ripple current measurement setup

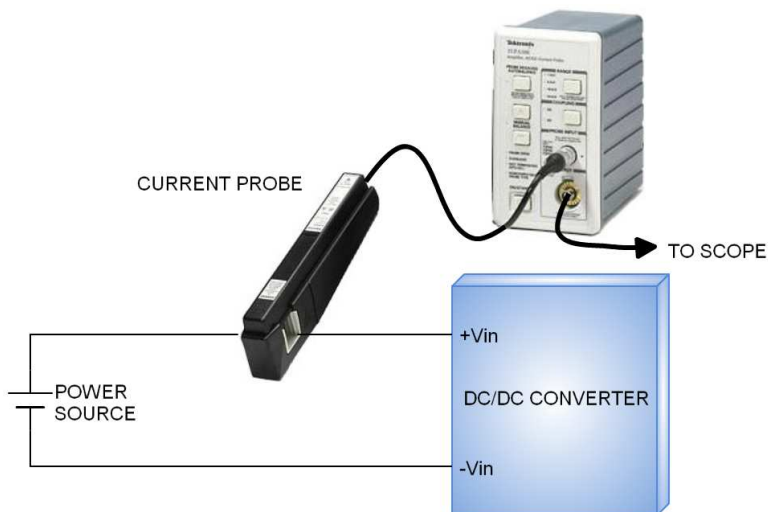

Output Over Current Protection

When excessive output currents occur in the system, circuit protection is required on all power supplies. Normally, overload current is maintained at approximately 150 percent of rated current for DPX15-xxWDxx series.

Hiccup-mode is a method of operation in a power supply whose purpose is to protect the power supply from being damaged during an over-current fault condition. It also enables the power supply to restart when the fault is removed. There are other ways of protecting the power supply when it is over-loaded, such as the maximum current limiting or current fold-back methods.

One of the problems resulting from over current is that excessive heat may be generated in power devices; especially MOSFET and Schottky diodes and the temperature of those devices may exceed their specified limits. A protection mechanism has to be used to prevent those power devices from being damaged.

The operation of hiccup is as follows. When the current sense circuit sees an over-current event, the controller shuts off the power supply for a given time and then tries to start up the power supply again. If the over-load condition has been removed, the power supply will start up and operate normally; otherwise, the controller will see another over-current event and shut off the power supply again, repeating the previous cycle. Hiccup operation has none of the drawbacks of the other two protection methods, although its circuit is more complicated because it requires a timing circuit. The excess heat due to overload lasts for only a short duration in the hiccup cycle, hence the junction temperature of the power devices is much lower.

The hiccup operation can be done in various ways. For example, one can start hiccup operation any time an over-current event is detected; or prohibit hiccup during a designated start-up interval (usually a few milliseconds). The reason for the latter operation is that during start-up, the power supply needs to provide extra current to charge up the output capacitor. Thus the current demand during start-up is usually larger than during normal operation and it is easier for an over-current event to occur. If the power supply starts to hiccup once there is an over-current, it might never start up successfully. Hiccup mode protection will give the best protection for a power supply against over current situations, since it will limit the average current to the load at a low level, so reducing power dissipation and case temperature in the power devices.

Output Short Circuit Protection

Continuous and auto-recovery mode.

During an output short circuit, the converter shuts down. The average current during this condition will be very low.

Output Over Voltage Protection

The output over-voltage protection consists of output Zener diode that monitors the voltage on the output terminals. If the voltage on the output terminals exceeds the over-voltage protection threshold, then the Zener diode clamps the output voltage.

Remote On/off Control

The Ctrl Pin is used to turn the DC/DC power module on and off. The user must use a switch to control the logic voltage (high or low) level of the pin referenced to $-V_{in}$. The switch can be an open collector transistor, FET, or Photo-Coupler. The switch must be capable of sinking up to 1 mA at low-level logic voltage. A High-level logic of the Ctrl pin signal should be limited to a maximum voltage of 12V and a maximum current of 0.5 mA.

Remote ON/OFF Implementation

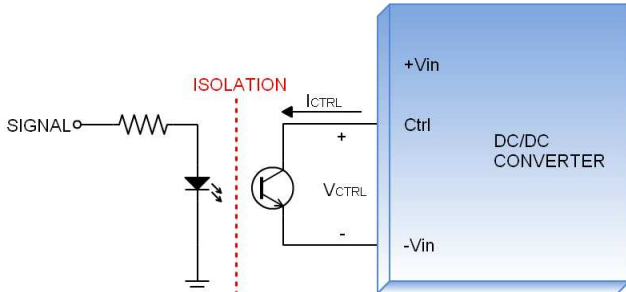

Isolated-Closure Remote ON/OFF

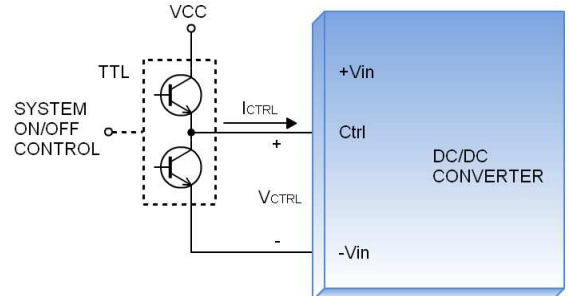

Level Control Using TTL Output

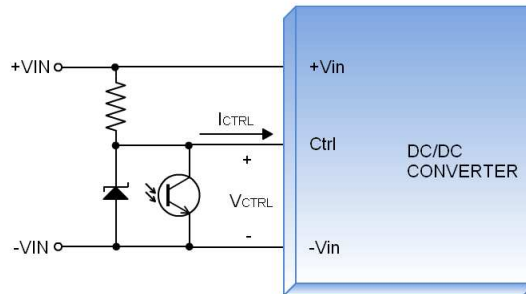

Level Control Using Line Voltage

There are two remote control options available, positive logic (optional) and negative logic (optional).

a. The positive logic structure turns on the DC/DC module when the Ctrl pin is at a high-logic level and turns the module off using a low-logic level.

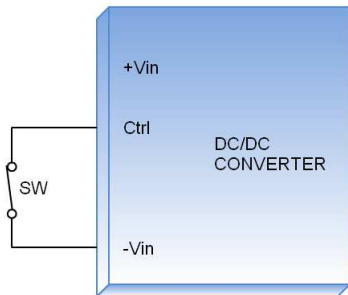

When DPX15-xxWDxx-P module is turned off using a Low-logic level

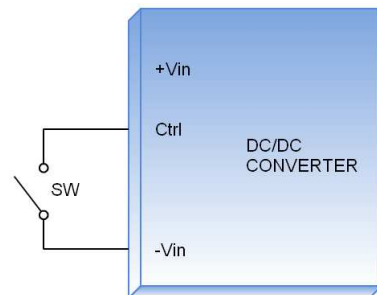

When DPX15-xxWDxx-P module is turned on using a High-logic level

b. The negative logic structure turns on the DC/DC module when the Ctrl pin is at a low-logic level and turns the module off when using a high-logic level.

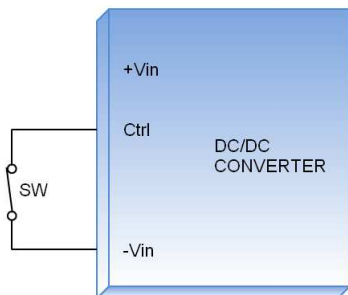

When DPX15-xxWDxx-N module is turned on using a Low-logic level

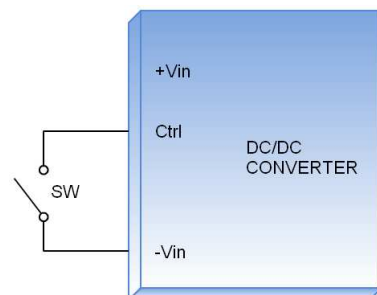

When DPX15-xxWDxx-N module is turned off using a High-logic level

EMS Considerations

The DPX15-xxWDxx series can meet Fast Transient EN61000-4-4 and Surge EN61000-4-5 performance criteria A. Please see the following schematic:

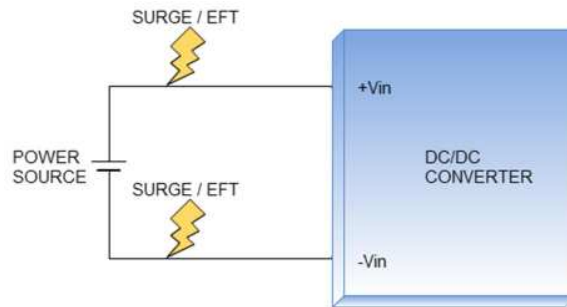

Mechanical Data

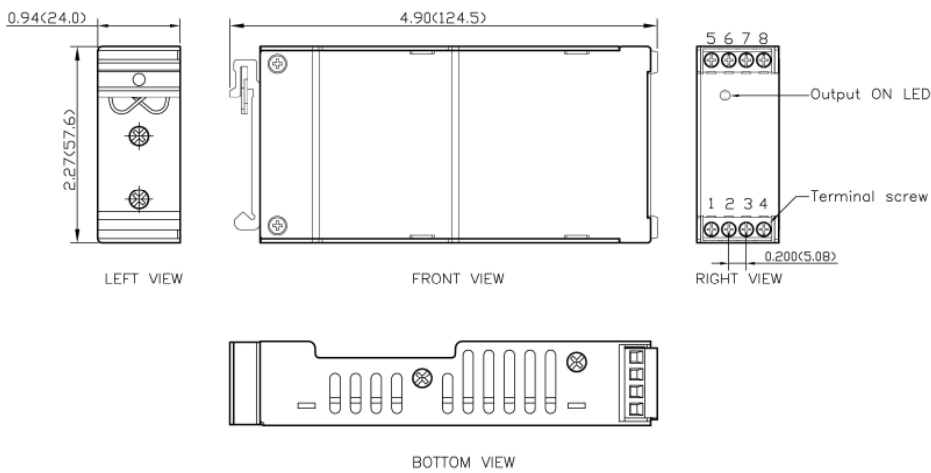

PINOUT

PIN	FUNCTION
1	Ctrl (Option)
2	-Vin
3	-Vin
4	+Vin
5	NC
6	-Vout
7	Common
8	+Vout

* NC : No Connection

* Screw terminals—wire range from 14 to 18 AWG

1. All dimensions in inch (mm)
2. Tolerance : X.XX±0.02 (X.X±0.5)
X.XXX±0.01 (X.XX±0.25)
3. Terminal screw locked torque :
MAX 2.5kgf—cm (0.25N—m)

Packaging Information

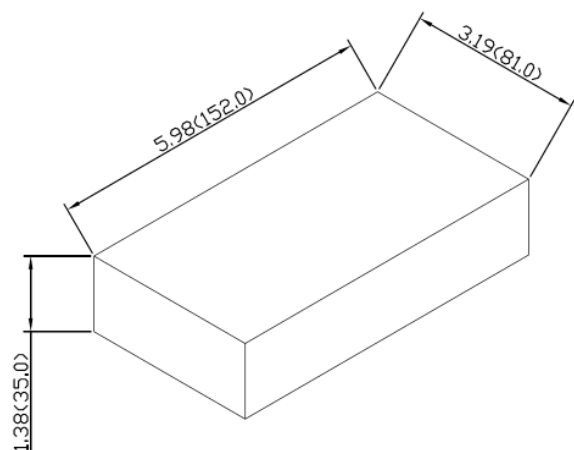
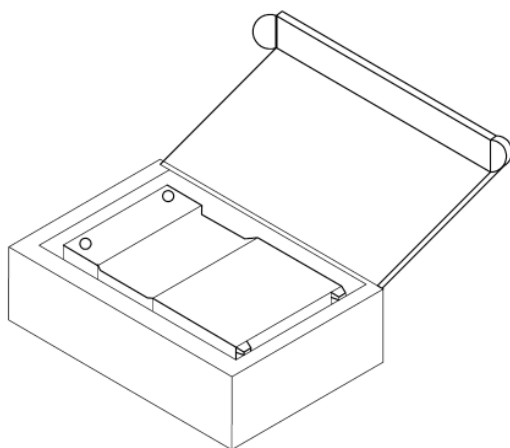

1PCS / BOX
All dimensions in mm

Part Number Structure

DPX15 - 48W D 05 - X

Series Name	Input Voltage (VDC)	Output Quantity	Output Voltage (VDC)	Remote Control Option
	24: 9.5~36 48: 18~75	D: Dual	05: ±5 12: ±12 15: ±15	P : Positive logic N: Negative logic

Model Number	Input Range VDC	Output Voltage VDC	Output Current @ Full Load mA	Input Current @ No Load mA	Efficiency %	Maximum Capacitor Load μF
DPX15-24WD05	9.5 ~ 36	±5	±1500	57	85	±3600
DPX15-24WD12	9.5 ~ 36	±12	±625	35	86	±625
DPX15-24WD15	9.5 ~ 36	±15	±500	35	86	±400
DPX15-48WD05	18 ~ 75	±5	±1500	37	86	±3600
DPX15-48WD12	18 ~ 75	±12	±625	20	86	±625
DPX15-48WD15	18 ~ 75	±15	±500	20	86	±400

MTBF and Reliability

The MTBF for the DPX15-xxWDxx series of DC/DC converters has been calculated using MIL-HDBK-217F @ at full load, operating temperature at 25°C. The resulting figure for MTBF is 1.681 × 10⁶ hours.