

200W Single Output DC-DC converters, 1/2 Brick

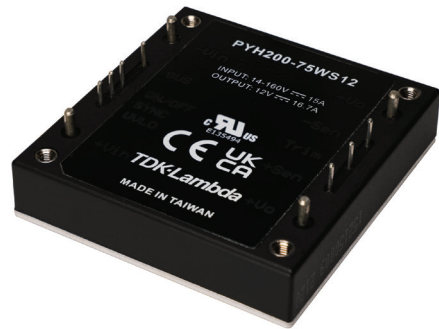

The 200W Half-brick footprint PYH series of isolated DC-DC converters operate from an ultra wide range input of 14 to 160Vdc (12:1) with single output voltages from 12V to 48V. The output voltage can be adjusted between -20% to +15% by using the trim terminal. Sense lines for the output voltage ensure a stable output voltage even with changing loads. The PYH200 models have efficiencies of up to 90% and can operate in ambient temperature of -40 to 100°C. The input to output isolation is 3,000Vac and the units are potted to provide a high resistance to shock and vibration. The converters are certified according to the 62368-1 safety standards and with additional circuits, the PYH200 series is also tested according to the EN 50155 railroad standard for electronic equipment in railroad vehicles.

Features	Benefits
• Half-Brick Footprint	• Industry Standard Package Size
• 14 - 160Vdc Wide Input Range (12:1)	• Supports the Majority of Railway DC Input Voltages
• Certified to IEC 62368-1, Tested According to EN 50155	• Easier System Compliance
• Potted Plastic Case	• High Resistance to Shock and Vibration
• 3000Vac Input to Output Isolation	• Suitable For Railway and Industrial Applications

Model Selector							
Model	Input Voltage (V)	Output Voltage (V)	Maximum Current (A)	Maximum Power (W)	No Load Input Current (mA)	Efficiency (%) at 72 / 110Vdc	Maximum Load Capacitance (uF)
PYH200-72WS12	14 - 160	12	16.7	200	50	90 / 90	16,700
PYH200-72WS15	14 - 160	15	13.5	200	50	90 / 89	13,500
PYH200-72WS24	14 - 160	24	8.4	200	50	88 / 88	8,000
PYH200-72WS48	14 - 160	48	4.2	200	50	88 / 89	2,200

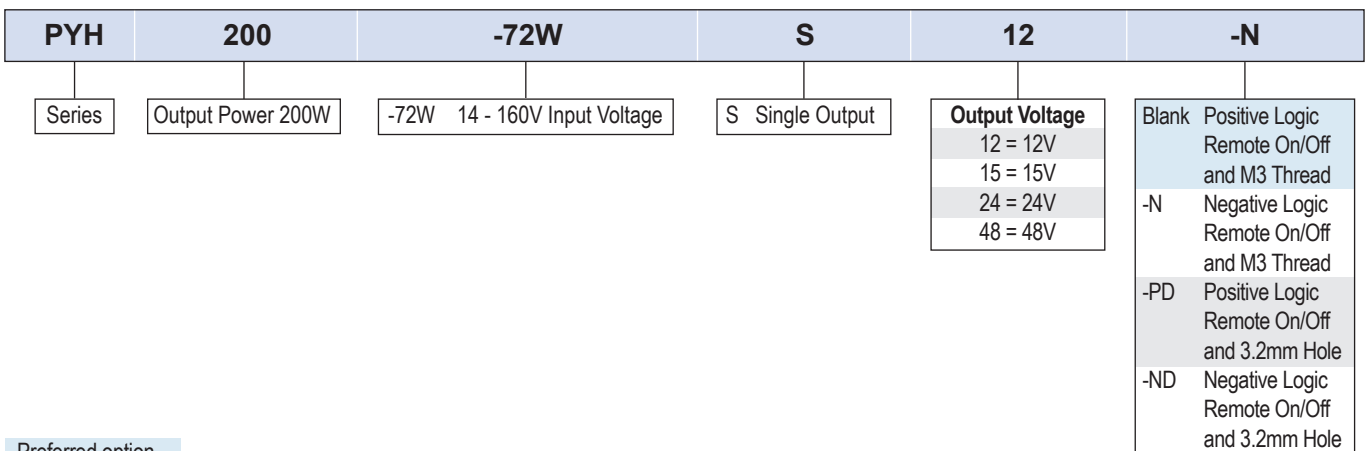

Related Products		
Type	Series	Description
Heatsink kit (User installation)	ACC-PYHB-HC01	HC1 heatsink, thermal pad, screws and washers
Heatsink kit (User installation)	ACC-PYHB-HC02	HC2 heatsink, thermal pad, screws and washers
Heatsink kit (User installation)	ACC-PYHB-HC05	HC3 heatsink, thermal pad, screws and washers
DC-DC Converter	PYD20	20W, Input 8.5-160V, 2" x 1"
DC-DC Converter	PYQ50	30-50W, Input 14-160V, quarter brick
DC-DC Converter	PYQ75	75W, Input 9-75V, quarter brick
DC-DC Converter	CN-B	200-300W, Input 60-160V, half brick

Specifications		
Model	PYH200	
Input		
Input Voltage Range	Vdc	14-160 Derate output power linearly from 200W to 150W between 16.5V and 14V input voltage
Input Surge Voltage	Vdc	180 (100ms maximum)
Input Shutdown Voltage	Vdc	13 Typ. (for all models at 70% load, when UVLO pin is left open, can be adjusted with external resistor)
Start-up Time (typ)	ms	200 Typ.
Hold-up Time	-	Depending on the capacitor connected to the BUS pin, see table below
No Load Current Consumption	-	See model selector table. Typically 15mA when remote on/off is activated
Efficiency	-	See model selector table
Conducted & Radiated EMI	-	EN55032. See installation manual for external circuitry
Immunity	-	See immunity section
Railroad Applications	-	EN 50155, EN45545-2, EN 61373, EN 50121-3-2: See application note for railroad use
Safety Certification and Markings	-	IEC/UL/CSA/EN62368-1, CE Mark and UKCA Mark

Immunity				
Test	Standard	Test Level	Criteria	Notes (See installation manuals for external circuitry)
ESD	EN61000-4-2	Air ± 8kV and Contact ± 6kV	A	-
Radiated Susceptibility	EN61000-4-3	20V/m	A	-
Electrical Fast Transient Burst	EN61000-4-4	± 2kV	A	With an input filter of two 100uF capacitors and a 180V supressor diode (SMCJ180A)
Surge	EN61000-4-5	± 2kV	A	
Conducted Susceptibility	EN61000-4-6	10 Vrms	A	-

Specifications		
Model	PYH200	
Output		
Output Voltage Tolerance	%	±1
Output Voltage Adjustment	%	-20/+15
Switching Frequency	kHz	432-528
Ext.Switching Frequency Synchronization	-	Yes, use Sync pin, see installation manual for external circuitry
Line Regulation	%	±0.2
Load Regulation	%	±0.2
External Load Capacitance	-	See model selector table
Ripple & Noise(1)	mVp-p	200 (12V, 15V models), 240 (24V, 48V models)
Temperature Coefficient	%/°C	±0.02
Minimum Load	-	No minimum load required
Transient Loading	-	250us recovery time for a 25% load change
Overcurrent Protection (typ)	%	110-140 (hiccup mode)
Overvoltage Protection (typ)	%	117-140
Overtemperature Protection	°C	105, automatic recovery when temperature falls below 95°C
Remote Sense	%	±15
Remote On/Off	-	Positive Logic (Blank): ON: Open or 3.5-160V, OFF Short or 0-1.2V Negative Logic (-N): ON: Short or 0-1.2V, OFF: Open or 3.5-160V

Specifications		
Model		PYH200
Environmental		
Operating Temperature ⁽²⁾	°C	-40 to +100 (see derating section and confirm case temperatures in end system)
Maximum Case Temperature	°C	100
Storage Temperature	°C	-55 to +125
Humidity (non condensing)	%RH	95 (maximum, for operation & storage)
Cooling	-	Convection, conduction or forced air
Altitude	m	5,000 (operating)
Withstand Voltage (For 1 minute)	-	Input to output 3000Vac or 4200Vdc, input to base plate 3000Vac or 4200Vdc, output to base plate 500Vac or 700Vdc
Isolation Capacitance	pF	500 (input to output)
Vibration (Operating)	-	MIL-STD-810F
Thermal Shock	-	MIL-STD-810F
Other		
Weight (Typ)	g	105
Size (LxWxH)	mm	61.0 x 57.9 x 12.7
Size (LxWxH)	Inches	2.4 x 2.28 x 0.5
Case Material	-	Plastic
Base Plate Material	-	Aluminum
MTBF - MIL-HDBK-217F, Full Load, GB25	Hours	475,000 - 629,000 depending on model
Warranty	yrs	3

Notes

See website for detailed specifications, test methods and installation manual

- (1): Measured with a 10uF tantalum/ aluminium capacitor and a 1.0uF multi-layer ceramic capacitors in parallel t the measurement path.
- (2). The case temperature must be confirmed in the end application. The product rating may be affected by airflow direction and physical obstructions near the module.

Derating Curve - Vertical Mount, Natural Convection

The possible temperature range depends on the power dissipation at the operating point of the DC-DC converter and the cooling method used. See installation manual for details.

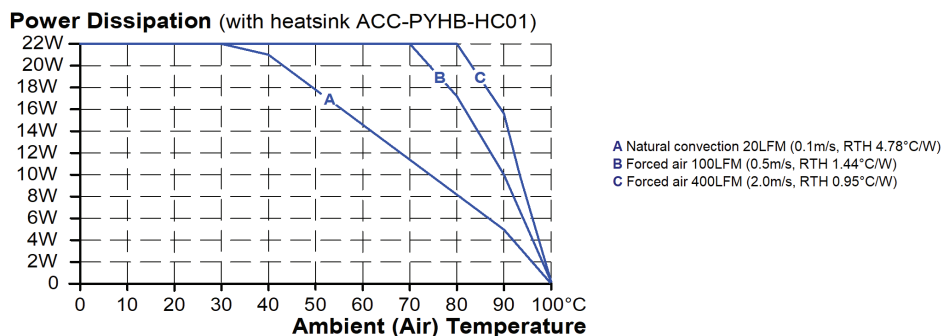
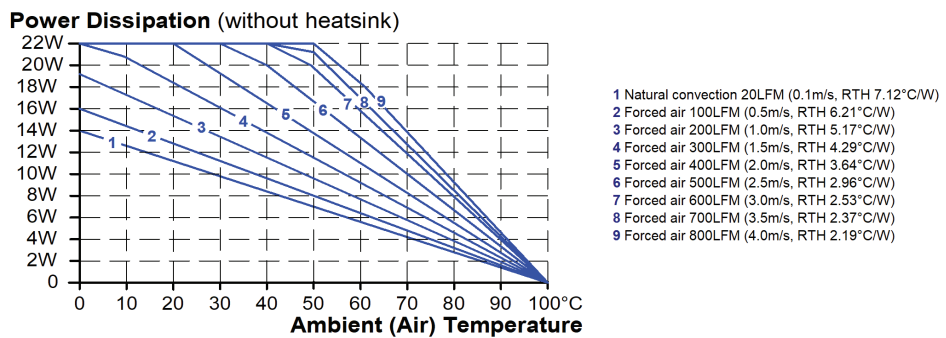

Hold-up Time

The hold time is defined as the time period during which the DC-DC converter output remains active after a loss of input power. The DC-DC converter itself is not capable of providing a hold time. For this, an external circuit with a large hold-up (storage) capacitor is required. See installation manual for details.

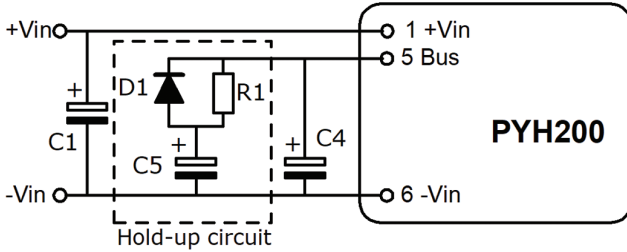

Input Voltage (Vdc)	Capacitor for 10ms hold-up time (µF)	Capacitor for 30ms hold-up time (µF)
24	2400	7200
36	2400	7200
48	2400	7200
72	2400	7200
96	820	2460
110	560	1680

Outline Drawing and Pinout

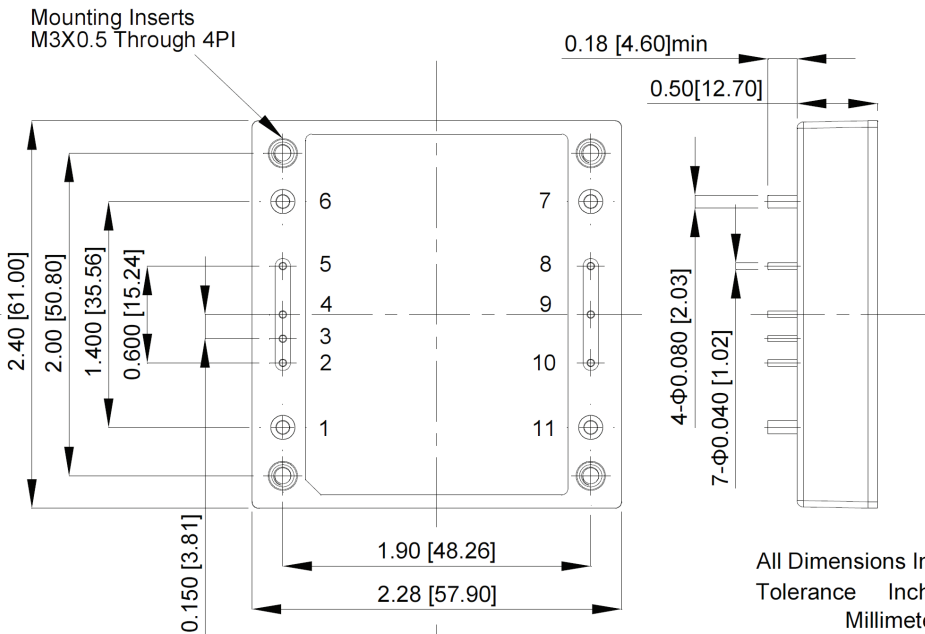

PIN	Function
1	+V Input
2	UVLO
3	Sync
4	On/Off
5	BUS
6	-V Input
7	-V Output
8	-Sense
9	Trim
10	+Sense
11	+V Output

All Dimensions In Inches[mm]
 Tolerance Inches:x.xx= ±0.02, x.xxx= ±0.010
 Millimeters:x.x= ±0.5, x.xx=±0.25

Recommendations for Pad Design:

- Pin 1, 6, 7, 11: 2.4mm through hole 4.8mm pad size
- Pin 2, 3, 4, 5, 7, 8, 9, 10: 1.4mm through hole 2.8mm pad size
- Converter Screws: 3.5mm through hole

Recommended Wiring Scheme

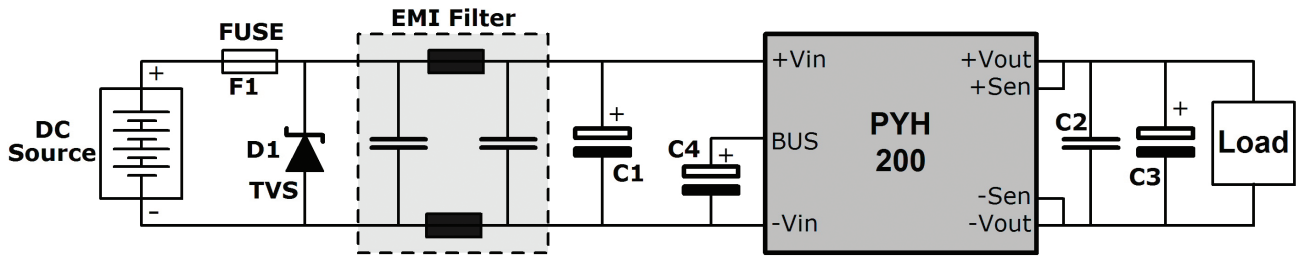

Fuse F1: The DC-DC converter is not internally fused. An external input fuse must always be used. Use a 25A slow-blow fuse.

Capacitor C1 and Diode D1: These two components provide higher transient resistance (surge and burst) at the input and are required if the DC-DC converter has to meet the EN61000-4-4 and EN61000-4-5 standards. The capacitor C1 should be 100µF/200V and the suppressor diode D1 should be a SMCJ180A.

EMI Filter: This filter reduces the conducted emission to the input. See installation manual for details.

Capacitor C2, C3: For a good transient response behavior, low ESR output capacitors should be utilized. Use a 1µF ceramic multilayer capacitor for C2 and a 10µF aluminum or tantalum capacitor for C3.

Capacitor C4: External capacitor connected between BUS and -Vin is necessary to keep operating stable. Use an aluminum capacitor with 240µF (e.g. VISHAY 118 AHT series)

Heatsinks

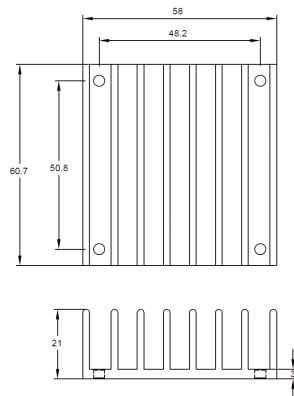

ACC-PYHB-HC05
Longitudinal

Fin Style	Longitudinal
Size (L x W x H)	58 x 60.7 x 21mm
Thermal Impedance	3.90°C/W nat. convection
	1.74°C/W with 100LFM
	1.33°C/W with 200LFM
	1.12°C/W with 300LFM
	0.97°C/W with 400LFM

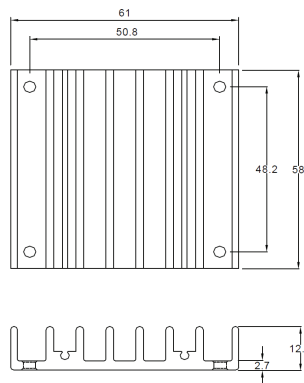

ACC-PYHB-HC02
Transverse

Fin Style	Transverse
Size (L x W x H)	61 x 58 x 12.7mm
Thermal Impedance	4.70°C/W nat. convection
	2.89°C/W with 100LFM
	2.30°C/W with 200LFM
	1.88°C/W with 300LFM
	1.59°C/W with 400LFM

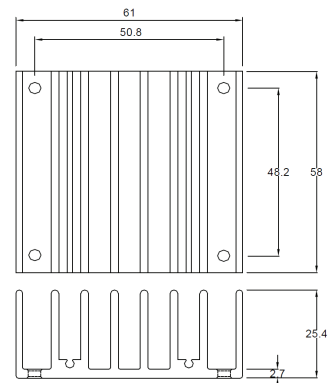

ACC-PYHB-HC01
Transverse

Fin Style	Transverse
Size (L x W x H)	61 x 58 x 25.4mm
Thermal Impedance	3.00°C/W nat. convection
	1.44°C/W with 100LFM
	1.17°C/W with 200LFM
	1.04°C/W with 300LFM
	0.95°C/W with 400LFM



TDK-Lambda France SAS

Tel: +33 1 60 12 71 65
france@fr.tdk-lambda.com
www.emea.lambda.tdk.com/fr



Italy Sales Office

Tel: +39 02 61 29 38 63
info.italia@it.tdk-lambda.com
www.emea.lambda.tdk.com/it



Netherlands

info@nl.tdk-lambda.com
www.emea.lambda.tdk.com/nl



TDK-Lambda Germany GmbH

Tel: +49 7841 666 0
info@de.tdk-lambda.com
www.emea.lambda.tdk.com/de



Austria Sales Office

Tel: +43 2256 655 84
info@at.tdk-lambda.com
www.emea.lambda.tdk.com/at



Switzerland Sales Office

Tel: +41 44 850 53 53
info@ch.tdk-lambda.com
www.emea.lambda.tdk.com/ch



Nordic Sales Office

Tel: +45 8853 8086
info@dk.tdk-lambda.com
www.emea.lambda.tdk.com/dk



TDK-Lambda UK Ltd.

Tel: +44 (0) 12 71 85 66 66
info@uk.tdk-lambda.com
www.emea.lambda.tdk.com/uk



TDK-Lambda Ltd.

Tel: +9 723 902 4333
info@tdk-lambda.co.il
www.emea.lambda.tdk.com/il



C.I.S.

Commercial Support:

Tel: +7 (495) 665 2627

Technical Support:

Tel: +7 (812) 658 0463
info@tdk-lambda.ru
www.emea.lambda.tdk.com/ru



TDK-Lambda Americas

Tel: +1 800-LAMBDA-4 or 1-800-526-2324
powersolutions@us.tdk-lambda.com
www.us.lambda.tdk.com



TDK Electronics do Brasil Ltda

Tel: +55 11 3289-9599
sales.br@tdk-electronics.tdk.com
www.tdk-electronics.tdk.com/en



TDK-Lambda Corporation

Tel: +81-3-6778-1113
www.jp.lambda.tdk.com



TDK-Lambda (China) Electronics Co. Ltd.

Tel: +86 21 6485-0777
powersolutions@cn.tdk-lambda.com
www.lambda.tdk.com.cn



TDK-Lambda Singapore Pte Ltd.

Tel: +65 6251 7211
tis.mkt@sg.tdk-lambda.com
www.sg.lambda.tdk.com



TDK India Private Limited, Power Supply Division

Tel: +91 80 4039-0660
mathew.philip@in.tdk-lambda.com
www.sg.lambda.tdk.com

