

# Z400<sup>+</sup> Series

IEC 61000

DATA

DWG. No. IA710-58-01		
APPD	CHK	DWG
Doron P.		yanir
Jan - 8 - 2012	5/1/12	05.01.2012

<b>INDEX</b>	<b>PAGE</b>
1. Electrostatic Discharge Immunity Test (IEC61000-4-2)	R-1
2. Radiated Radio-Frequency Electromagnetic Field Immunity Test (IEC61000-4-3)	R-2
3. Electrical Fast Transient / Burst Immunity Test (IEC61000-4-4)	R-3
4. Surge Immunity Test (IEC61000-4-5)	R-4
5. Conducted Disturbances Induced by Radio-Frequency Field Immunity Test (IEC61000-4-6)	R-5
6. Power Frequency Magnetic Field Immunity Test (IEC61000-4-8)	R-6
7. Voltage Dips, Short Interruptions Immunity Test (IEC61000-4-11)	R-7
8. Input Current Harmonics Test (IEC61000-3-2)	R-8

\* Test results are typical data. Nevertheless the following results are considered to be actual capability data because all units have nearly the same characteristics.

1. Electrostatic Discharge Immunity Test (IEC61000-4-2)

(1) Equipment used

Electrostatic discharge simulator: ESS-2000 (NOISEKEN)

Discharge resistance: 330Ω

Capacitor: 150pF

(2) Test conditions

Input voltage: 115,230Vac

Output voltage: 100%

Output current: 100%

Polarity: -,+

Number of tests: 10 times

Ta: 25°C

Discharge interval: >1 Second

(3) Test method and Device test point

Contact discharge: FG, Case screw

Air discharge: Input and Output terminal

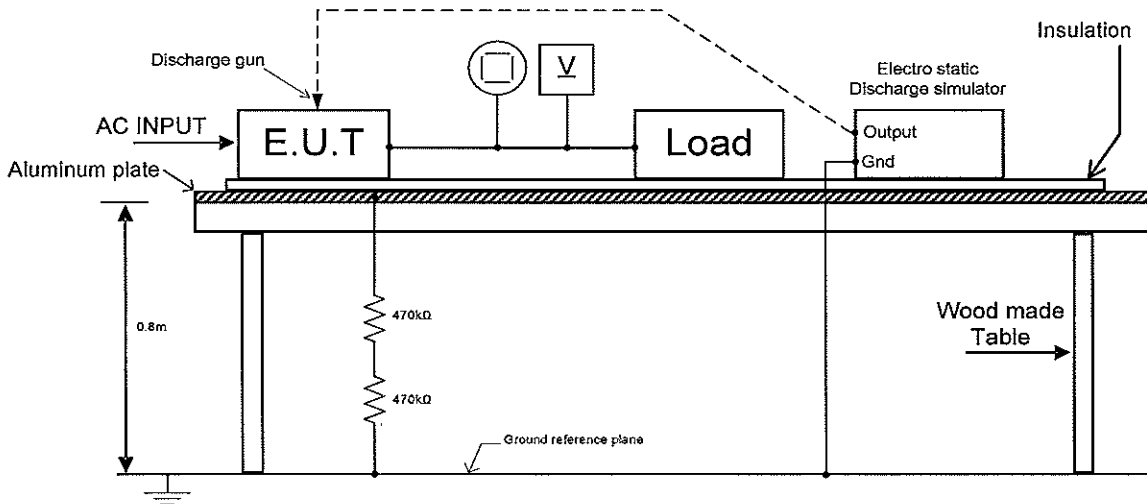

(4) Acceptable conditions

1. Output voltage regulation not to exceed ± 5% of initial (before test) value during test.
2. Output voltage to be within regulation specification after the test.
3. Along with 1 and 2, no discharge of fire or smoke, as well as no output failure.

(5) Test Result

Contact Discharge (KV)	Z100-4	Air Discharge (KV)	Z100-4
4	PASS	8	PASS

**2. Radiated Radio-Frequency Electromagnetic Field Immunity Test (IEC61000-4-3)**

**(1) Equipment used**

Test Laboratory: Hermon Laboratories Ltd.

**(2) Test conditions**

Input voltage: 115,230Vac

Output voltage: 100%

Output current: 100%

Amplitude Modulated: 80%,1kHz

Electromagnetic Frequency: 80~1000MHz

Ambient temperature: 25°C

Distance: 2.4m

Wave Angel: Horizontal and Vertical

Sweep condition: 1.0% Step Up, 2.8 second Hold

Test Angle: Top/Bottom, Both Sides, Front/Back

**(3) Test Method:**

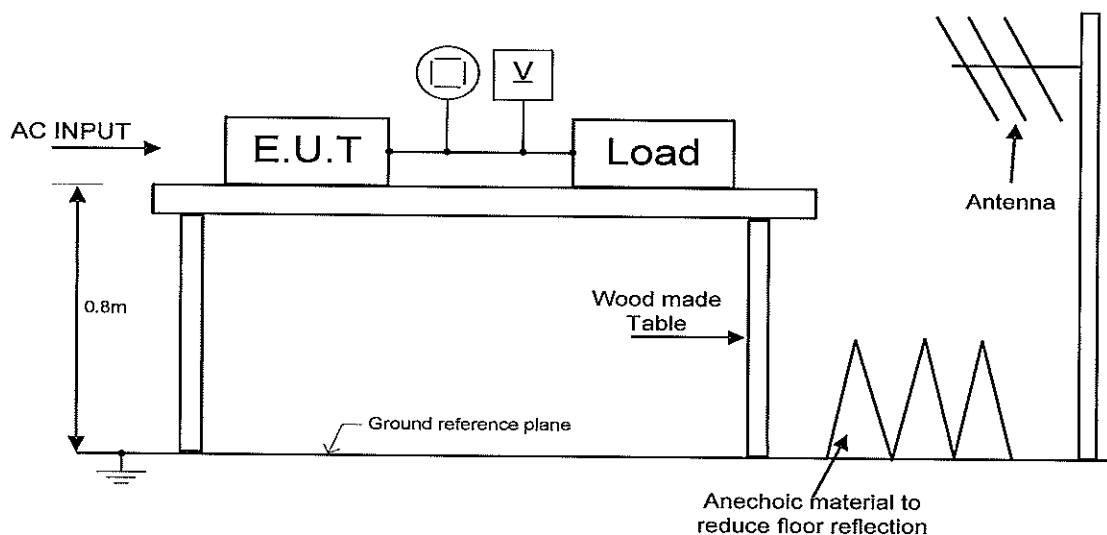

**(4) Acceptable conditions**

1. Output voltage regulation not to exceed  $\pm 5\%$  of initial (before test) value during test.
2. Output voltage to be within regulation specification after the test.
3. Along with 1 and 2, no discharge of fire or smoke, as well as no output failure.

**(5) Test Result**

Radiated Field Strength (V/m)	Z60-7
3	PASS

3. Electrical Fast Transient / Burst Immunity Test (IEC61000-4-4)

(1) Equipment used

EFT/B Generator: SCHAFFNER NSG2025

(2) Test conditions

Input voltage: 115,230Vac

Output voltage: 100%

Output current: 100%

Test time: 1 minute

Polarity: -,+

Ambient temperature: 25°C

Number of tests: 3 times

(3) Test method and Device test point

Neutral (N), Line (L), Ground (FG) apply pulses from EFT/B Generator to N, L, FG separately, as well as, all at the same time.

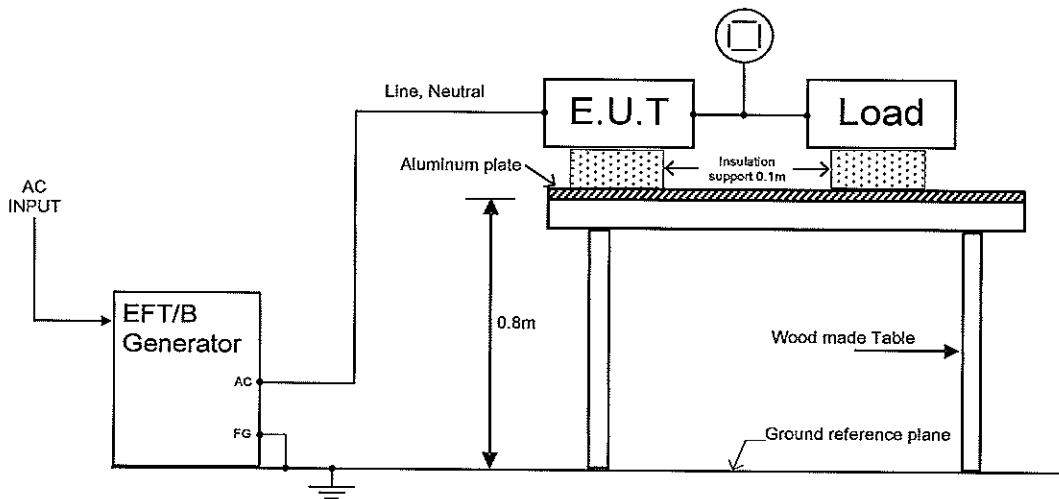

(5) Acceptable conditions

1. Output voltage regulation not to exceed  $\pm 5\%$  of initial (before test) value during test.
2. Output voltage to be within regulation specification after the test.
3. Along with 1 and 2, no discharge of fire or smoke, as well as no output failure.

(5) Test Result

Test Voltage (kV)	Repetition Rate (kHz)	Z60-7
2	5	PASS

4. Surge Immunity Test (IEC61000-4-5)

(1) Equipment used

Surge Generator: NSG651 (SCHAFFNER)

Coupling impedance: Common - 12Ω                      Normal - 2Ω

Coupling capacitance: Common - 9 uF                      Normal - 18 uF

Coupling network: CDN110 (SCHAFFNER)

(2) Test method and devise test point

Input voltage: 115,230Vac

Output voltage: 100%

Output current: 100%

Number of tests: 5 times

Polarity: -,+

Ambient temperature: 25°C

Phase: 0°, 90°

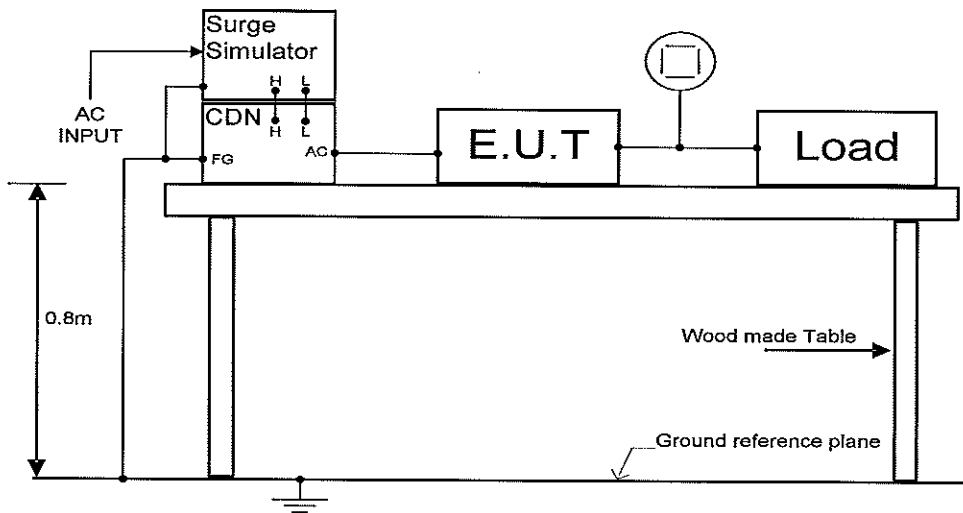

(3) Acceptable conditions

1. Output voltage regulation not to exceed  $\pm 5\%$  of initial (before test) value during test.
2. Output voltage to be within regulation specification after the test.
3. Along with 1 and 2, no discharge of fire or smoke, as well as no output failure.

(4) Test Result

Test Voltage (kV) Common	Z60-7	Test Voltage (kV) Normal	Z60-7
1.0	PASS	1.0	PASS
2.0	PASS		

**5. Conducted Disturbances Induced by Radio-Frequency Field Immunity Test (IEC61000-4-6)**

**(1) Equipment used**

RF Signal Generator 10kHz-1050MHz:	Fluke,6061A
RF Amplifier 10kHz-220MHz,150W:	Amplifier Research,150L
Coupling/Decoupling Network:	HL CDN 801-M3

**(2) Test Condition:**

Output voltage: 100%	Electromagnetic Frequency: 150kHz~80MHz
Input voltage: 115,230Vac	Type of modulation: AM 80% @ 1khz
Output current: 100%	Test Voltage: 3V <sub>rms</sub> prior to modulation
	Dwell Time: 3s
	Frequency Step: 1.0% of current frequency

Ambient temperature: 25°C

**(3) Test Method:**

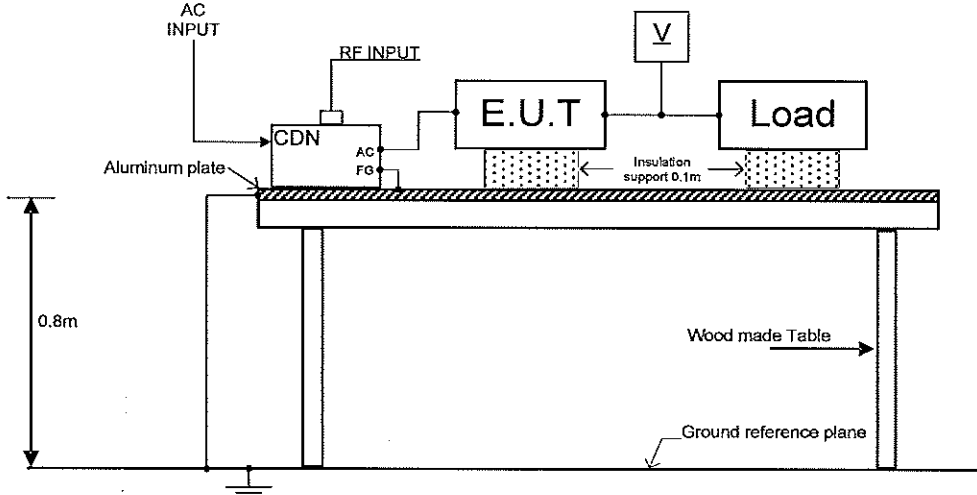

**(4) Acceptable conditions**

1. Output voltage regulation not to exceed  $\pm 5\%$  of initial (before test) value during test.
2. Output voltage to be within regulation specification after the test.
3. Along with 1 and 2, no discharge of fire or smoke, as well as no output failure.

**(5) Test Result**

Test Voltage Level (V)	Z60-7
3	PASS

6. Power Frequency Magnetic Field Immunity Test (IEC61000-4-8)

(1) Equipment used

Test Laboratory: Hermon Laboratories Ltd.

(2) Test Condition:

Input voltage: 115,230Vac	Output voltage: 100%
Output current: 100%	Frequency: 50Hz
Magnetic Field Strength: 30A/m	Direction: X, Y, Z
Duration Time: 10min.	Ambient temperature: 25°C

(3) Test Method:

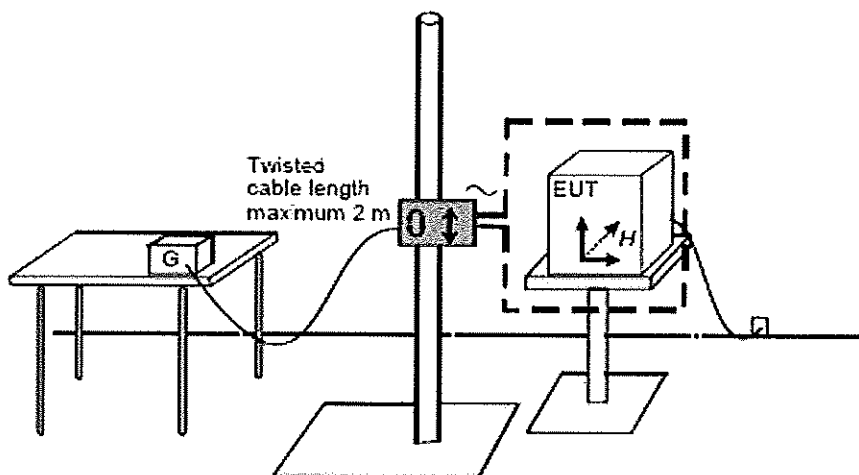

(4) Acceptable conditions

1. Output voltage regulation not to exceed  $\pm 5\%$  of initial (before test) value during test.
2. Output voltage to be within regulation specification after the test.
3. Along with 1 and 2, no discharge of fire or smoke, as well as no output failure.

(5) Test Result

EUT positions	Result
X	PASS
Y	PASS
Z	PASS



## 7. Voltage Dips, Short Interruptions Immunity Test (IEC61000-4-11)

Z400

### (1) Equipment used

AC Source: 6590 (CHROMA)

Oscilloscope: DL1740EL (Yokogawa)

### (2) Test Condition:

Input voltage: 115,230Vac

Output voltage: 100%

Output current: 100%

Frequency: 50Hz

Repetition: 0.1Hz

Ambient temperature: 25°C

Number of tests: 3 times

### (3) Test Method:

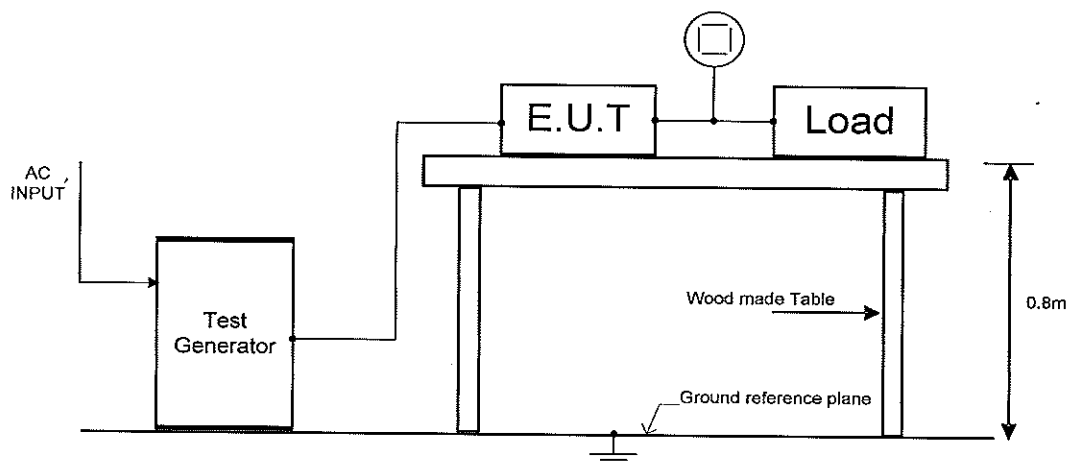

### (4) Acceptable conditions

1. Output voltage to be within output voltage regulation specification after the test.
2. Along with 1 and 2, no discharge of fire or smoke, as well as no output failure.

### (5) Test Result

Test level	Dip rate	Continue time $t_s$	Result
70%	30%	500ms	PASS
40%	60%	200ms	PASS
0%	100%	5000ms	PASS

8. Input Current Harmonics Test (IEC61000-3-2)

(1) Equipment used

AC Power Analyzer: WT110 (Yokogawa)

AC Source: 6590 (CHROMA)

(2) Test conditions:

Input voltage: 115, 230Vac

Output current: 100%

Output Voltage: 100%

(3) Test Method:

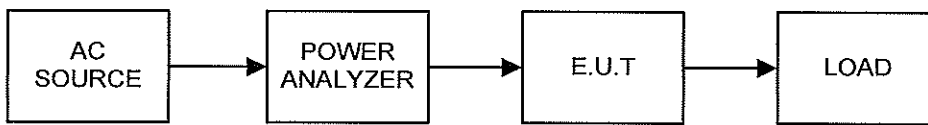

Vin: 115Vac

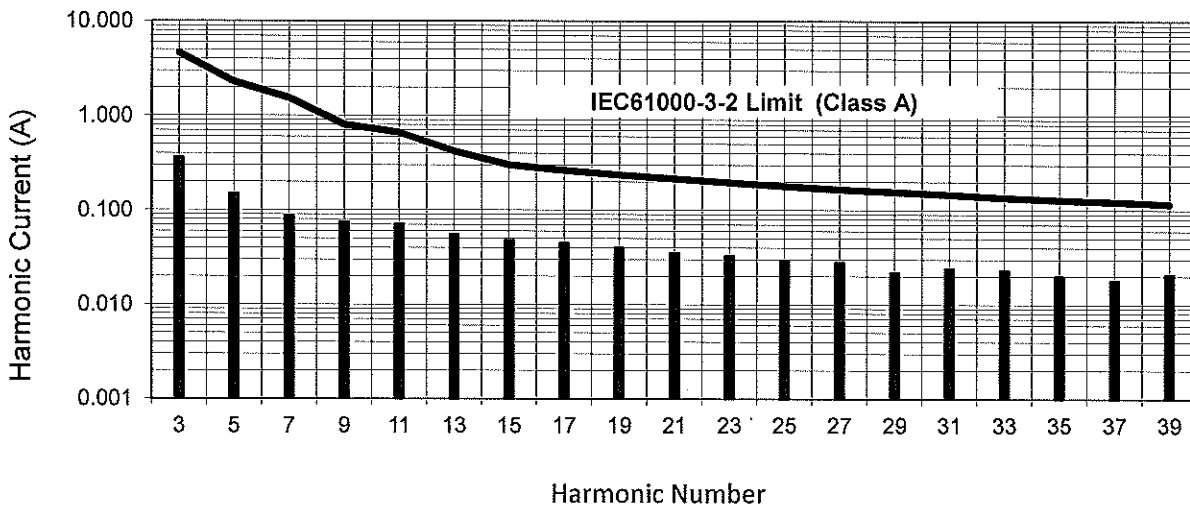

Vin: 230Vac

