

GENESYS™ 1.7kW

EVALUATION

DATA

DWG: IA845-53-01		
APPD	CHK	DWG
Sergey.K 4/9/2018	Urim 4/9/2018	MICHAEL C. 4.9.2018

TDK-LAMBDA

INDEX	PAGE
1. EVALUATION METHOD	
1.1 Circuit used for determination	
(1) Steady state data	T-1
(2) Over voltage protection (OVP) characteristics	T-1
(3) Output rise/fall characteristics	T-1
(4) Dynamic line response characteristic	T-2
(5) Dynamic load response characteristics	T-2
(6) Inrush current characteristics	T-3
(7) Leakage current characteristics	T-3
(8) Output ripple & noise waveform 10V to 300V models	T-3
(9) Output ripple & noise waveform for models higher than 300V	T-4
1.2 List of equipment used	T-5
2. CHARACTERISTICS	
2.1 Steady state data	
(1) Regulation - Line & Load, Temperature drift	T-6~9
(2) Output voltage and ripple voltage VS input voltage	T-10~11
(3) Efficiency and Input current VS Output current	T-12~13
2.2 Warm up voltage drift & temperature stability	T-14~17
2.3 Over voltage protection (OVP) characteristic	T-18~19
2.4 ON/OFF Output rise characteristics	T-20~27
2.5 ON/OFF Output fall characteristics	T-28~35
2.6 Hold up time characteristic	T-36~39
2.7 Dynamic line response	T-40~47
2.8 Dynamic load response	T-48~53
2.9 Response to brown-out characteristic	T-54~61
2.10 Inrush current characteristic	T-62~63
2.11 Inrush current waveform	T-64~65
2.12 Input current waveform	T-66~67
2.13 Leakage current characteristic	T-68
2.14 Output ripple & noise waveform	T-69~70
TERMINOLOGY USED	
Definition	
Vin	Input voltage
Vout	Output voltage
Iin	Input current
Iout	Output current
Ta	Ambient temperature
C.V	Constant voltage mode
C.C	Constant current mode

1. EVALUATION METHOD

1.1 Circuit used for determination

(1) Steady state data

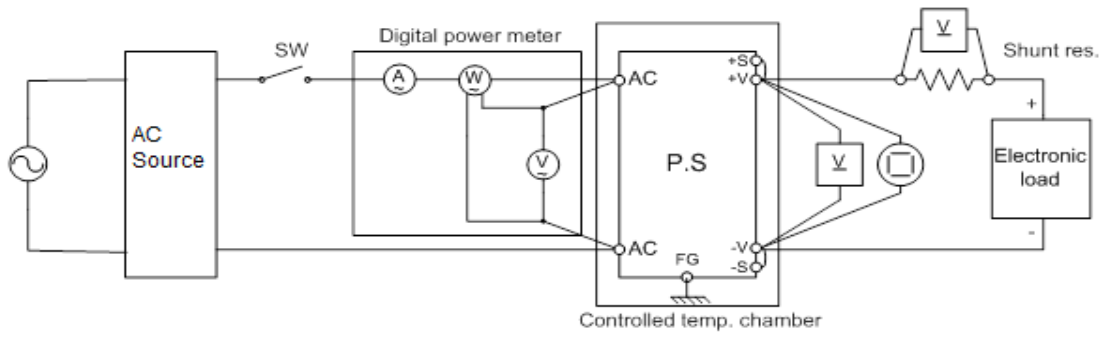

(2) Over voltage protection (OVP) characteristics

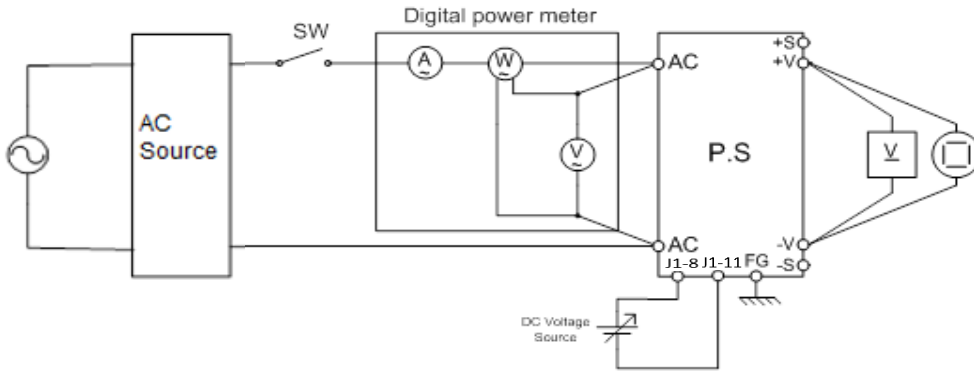

(3) Output rise/fall characteristics

Constant Voltage mode

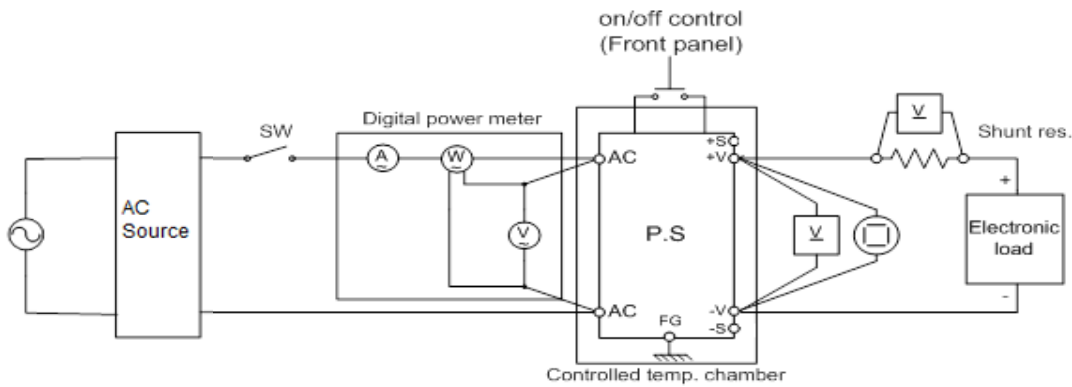

Constant Current mode

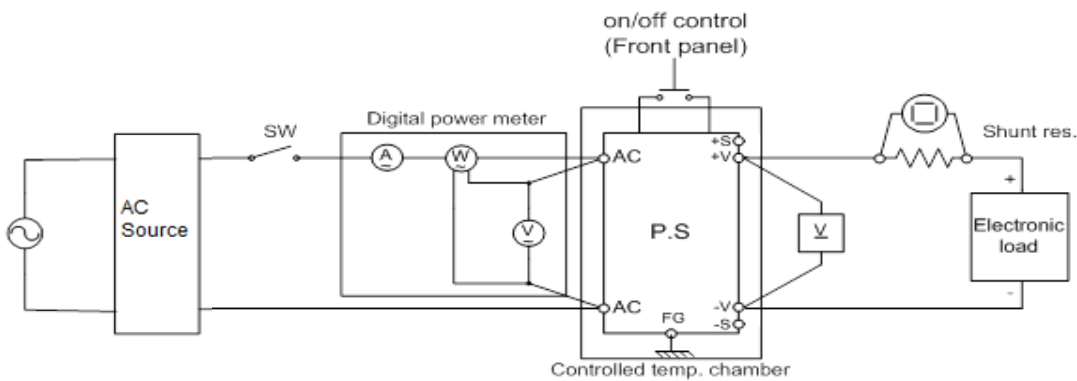

(4) Dynamic line response characteristics

Constant Voltage mode

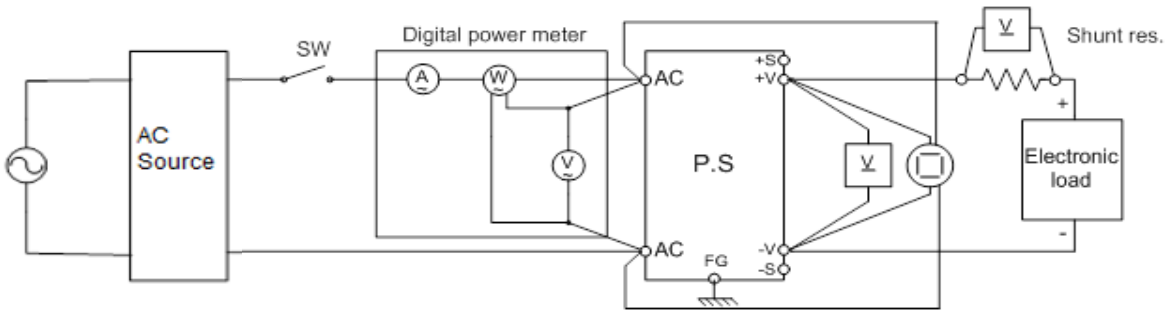

Constant Current mode

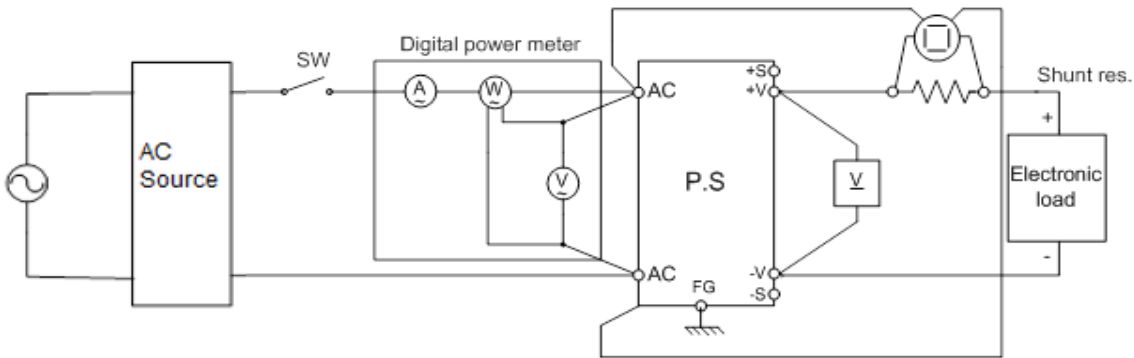

(5) Dynamic load response characteristics

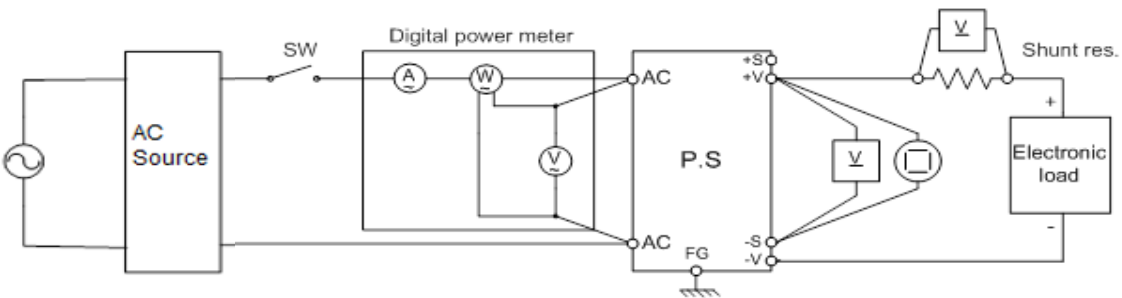

Output current waveform

load 0% <---> 100%

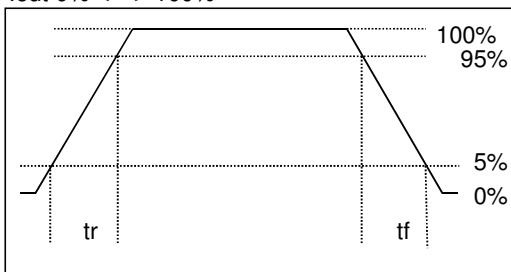

Output current waveform

load 50% <---> 100%

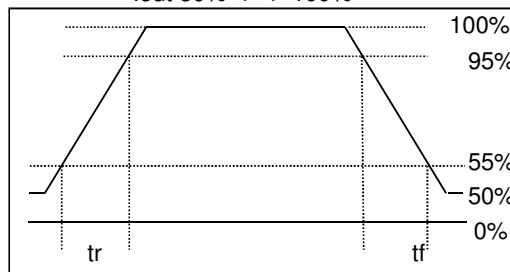

(6) Inrush current characteristics

Constant Voltage mode

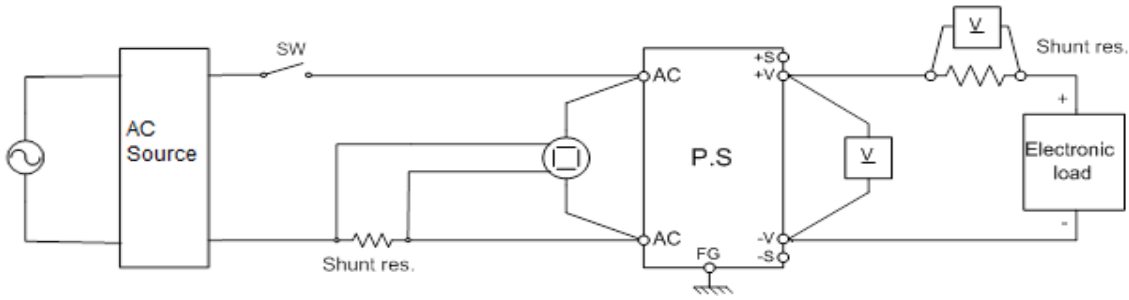

(7) Leakage current characteristics

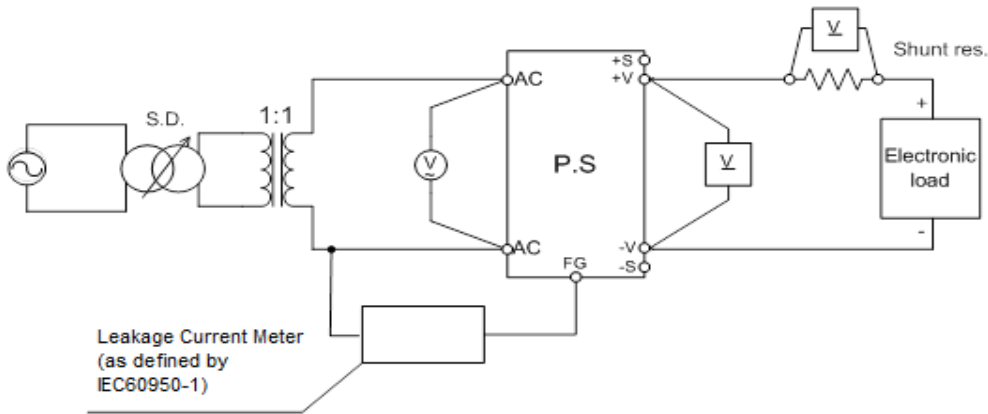

(8) Output ripple & noise waveform (10V to 300V models)

(a) Normal mode (JEITA Standard RC-9131A)

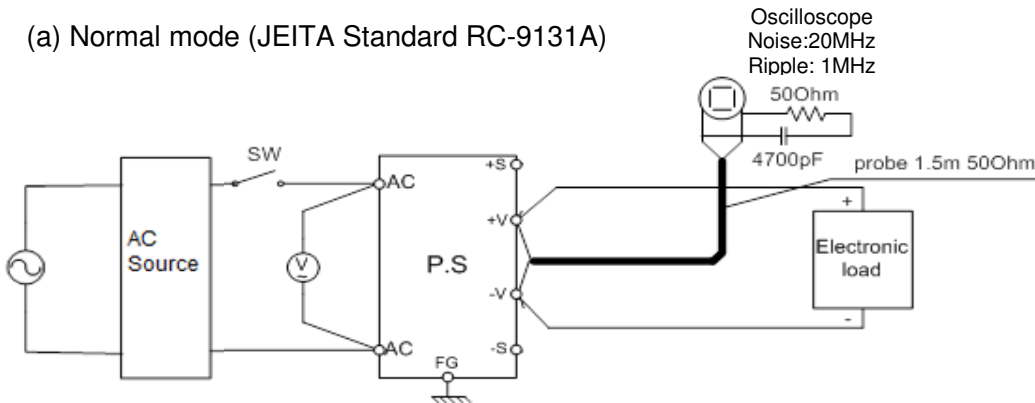

(b) Normal + Common mode

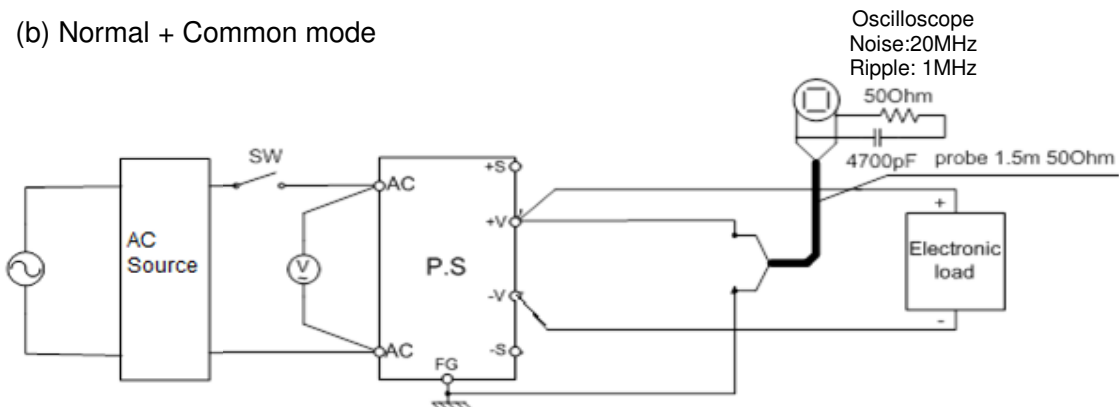

(9) Output ripple & noise waveform (400V to 600V models)

(a) Normal mode

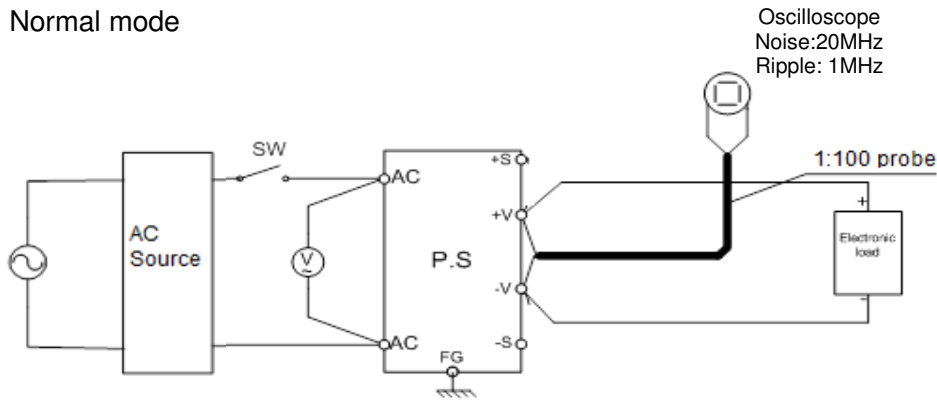

(b) Normal + Common mode

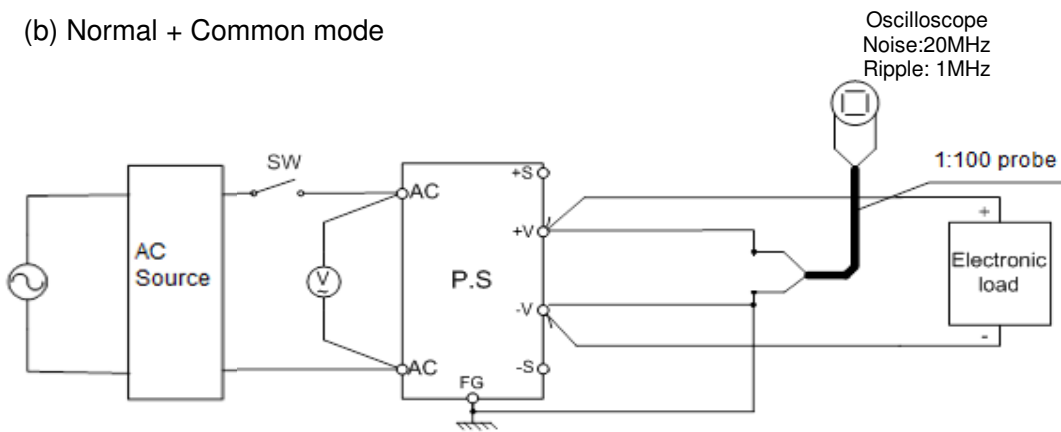

1.2 List of equipment used

	EQUIPMENT USED	MANUFACTURER	MODEL No.
1	Storage oscilloscope	YOKOGAWA	DLM2034
2	Storage oscilloscope	YOKOGAWA	DL1740
3	Digital multimeter	AGILENT	34401A
4	Digital power meter	YOKOGAWA	WT110
5	AC Source	CHROMA	6530
6	AC Source	CHROMA	6560
7	Electronic load	H&H	ZS1880
8	Electronic load	H&H	ZS4260
9	Electronic load	H&H	ZS7060
10	Electronic load	CHROMA	63201
11	Electronic load	CHROMA	63202
12	Electronic load	CHROMA	63206A
13	Controlled temp. chamber	THERMOTRON	SM-16-3800
14	Controlled temp. chamber	THERMOTRON	SE-600-5-5
15	Controlled temp. chamber	THERMOTRON	SE-600-6-6
16	Leakage current tester	KIKUSUI	TOS3200
17	Current probe	YOKOGAWA	701931
18	Transducer	LEM	IT700-SB
19	Transducer	LEM	IT60-S
20	Transducer	LEM	IT200-S

(1). Regulation - Line & Load, Temperature drift

G10-170

Conditions: Ta = 25°C

1. Regulation - Line & Load

Io	Vin						Line Regulation	
	85VAC	100VAC	115VAC	200VAC	230VAC	265VAC		
0%	9.9997	9.9997	9.9997	9.9997	9.9997	9.9997	0.0	0.000%
25%	9.9993	9.9993	9.9993	9.9993	9.9993	9.9993	0.0	0.000%
50%	9.9988	9.9988	9.9988	9.9989	9.9989	9.9989	0.1	0.001%
75%	9.9982	9.9982	9.9982	9.9982	9.9982	9.9982	0.0	0.000%
100%	9.9979	9.9979	9.9979	9.9979	9.9979	9.9979	0.0	0.000%
Load	1.8	1.8	1.8	1.8	1.8	1.8	$\Delta V(mV)$	
Regulation	0.018%	0.018%	0.018%	0.018%	0.018%	0.018%		

2. Temperature drift, C.V mode

Conditions: Vin:100VAC
Iout:100%

Ta	0°C	25°C	50°C	Temp. Coefficient (0°C~50°C)		
Vout	9.9979	9.9977	9.9975	0.4	mV	1 ppm/°C

G60-28

Conditions: Ta = 25°C

1. Regulation - Line & Load, C.V mode /

Io	Vin						Line Regulation	
	85VAC	100VAC	115VAC	200VAC	230VAC	265VAC		
0%	60.0332	60.0332	60.0333	60.0331	60.0333	60.0332	0.2	0.000%
25%	60.0322	60.0323	60.0323	60.0323	60.0324	60.0324	0.2	0.000%
50%	60.0320	60.0321	60.0321	60.0321	60.0321	60.0322	0.2	0.000%
75%	60.0316	60.0317	60.0317	60.0317	60.0318	60.0318	0.2	0.000%
100%	60.0309	60.0310	60.0312	60.0312	60.0313	60.0314	0.5	0.001%
Load	2.3	2.2	2.1	1.9	2.0	1.8	$\Delta V(mV)$	
Regulation	0.004%	0.004%	0.003%	0.003%	0.003%	0.003%		

2. Temperature drift, C.V mode

Conditions: Vin:100VAC
Iout:100%

Ta	0°C	25°C	50°C	Temp. Coefficient (0°C~50°C)		
Vout	59.9917	60.0018	60.0092	17.5	mV	6 ppm/°C

(1). Regulation - Line & Load, Temperature drift

G150-11.2

Conditions: Ta = 25°C

1. Regulation - Line & Load

Io	Vin						Line Regulation	
	85VAC	100VAC	115VAC	200VAC	230VAC	265VAC		
0%	149.9921	149.9926	149.9930	149.9929	149.9930	149.9931	1.0	0.001%
25%	149.9923	149.9923	149.9928	149.9923	149.9925	149.9924	0.5	0.000%
50%	149.9919	149.9922	149.9924	149.9923	149.9921	149.9924	0.5	0.000%
75%	149.9918	149.9922	149.9918	149.9920	149.9921	149.9921	0.4	0.000%
100%	149.9907	149.9912	149.9910	149.9911	149.9915	149.9914	0.8	0.001%
Load	1.6	1.4	2.0	1.8	1.5	1.7	$\Delta V(mV)$	
Regulation	0.001%	0.001%	0.001%	0.001%	0.001%	0.001%		

2. Temperature drift, C.V mode

Conditions: Vin:100VAC
Iout:100%

Ta	0°C	25°C	50°C	Temp. Coefficient (0°C~50°C)		
Vout	149.982	149.999	149.998	17	mV	2 ppm/°C

G600-2.8

Conditions: Ta = 25°C

1. Regulation - Line & Load, C.V mode /

Io	Vin						Line Regulation	
	85VAC	100VAC	115VAC	200VAC	230VAC	265VAC		
0%	599.9630	599.9630	599.9630	599.9630	599.9630	599.9630	0.0	0.000%
25%	599.9600	599.9600	599.9600	599.9600	599.9600	599.9600	0.0	0.000%
50%	599.9590	599.9590	599.9590	599.9590	599.9590	599.9590	0.0	0.000%
75%	599.9580	599.9580	599.9580	599.9580	599.9580	599.9580	0.0	0.000%
100%	599.9570	599.9570	599.9570	599.9570	599.9570	599.9570	0.0	0.000%
Load	6.0	6.0	6.0	6.0	6.0	6.0	$\Delta V(mV)$	
Regulation	0.001%	0.001%	0.001%	0.001%	0.001%	0.001%		

2. Temperature drift, C.V mode

Conditions: Vin:100VAC
Iout:100%

Ta	0°C	25°C	50°C	Temp. Coefficient (0°C~50°C)		
Vout	599.972	600.026	600.035	63	mV	2 ppm/°C

(1). Regulation - Line & Load, Temperature drift

G10-170

Conditions: Ta = 25°C

1. Regulation - Line & Load, C.C mode (*)

Vo	Vin						Line Regulation	
	85VAC	100VAC	115VAC	200VAC	230VAC	265VAC		
0%	169.7950	169.7950	169.7950	169.7950	169.7950	169.7950	0.0	0.000%
25%	169.7910	169.7910	169.7910	169.7910	169.7910	169.7910	0.0	0.000%
50%	169.7820	169.7820	169.7820	169.7820	169.7820	169.7820	0.0	0.000%
75%	169.7840	169.7840	169.7840	169.7840	169.7840	169.7840	0.0	0.000%
100%	169.7750	169.7750	169.7750	169.7750	169.7750	169.7750	0.0	0.000%
Load	20.0	20.0	20.0	20.0	20.0	20.0	ΔI(mA)	
Regulation	0.012%	0.012%	0.012%	0.012%	0.012%	0.012%		

2. Temperature drift, C.C mode

Conditions: Vin:100VAC
Iout:100%

Ta	0°C	25°C	50°C	Temp. Coefficient (0°C~50°C)	
Iout	169.899	169.769	169.673	226 mA	27 ppm/°C

G60-28

1. Regulation - Line & Load, C.C mode (*)

Vo	Vin						Line Regulation	
	85VAC	100VAC	115VAC	200VAC	230VAC	265VAC		
0%	27.9936	27.9935	27.9935	27.9937	27.9940	27.9940	0.5	0.002%
25%	27.9940	27.9941	27.9941	27.9941	27.9942	27.9942	0.2	0.001%
50%	27.9947	27.9949	27.9948	27.9945	27.9946	27.9948	0.4	0.001%
75%	27.9957	27.9959	27.9961	27.9957	27.9960	27.9962	0.5	0.002%
100%	27.9954	27.9955	27.9954	27.9951	27.9955	27.9956	0.5	0.002%
Load	2.1	2.4	2.6	2.0	2.0	2.2	ΔI(mA)	
Regulation	0.007%	0.009%	0.009%	0.007%	0.007%	0.008%		

2. Temperature drift, C.C mode

Conditions: Vin:100VAC
Iout:100%

Ta	0°C	25°C	50°C	Temp. Coefficient (0°C~50°C)	
Iout	27.9936	28.0116	28.0465	52.9 mA	38 ppm/°C

Notes:

(*) Not including load regulation thermal drift effect.

(1). Regulation - Line & Load, Temperature drift

G150-11.2

Conditions: Ta = 25°C

1. Regulation - Line & Load, C.C mode (*)

Vo	Vin						Line Regulation	
	85VAC	100VAC	115VAC	200VAC	230VAC	265VAC		
0%	11.1978	11.1979	11.1978	11.1976	11.1977	11.1976	0.3	0.003%
25%	11.1970	11.1974	11.1974	11.1971	11.1972	11.1972	0.4	0.004%
50%	11.1984	11.1987	11.1986	11.1983	11.1986	11.1986	0.4	0.004%
75%	11.1988	11.1991	11.1992	11.1987	11.1991	11.1991	0.5	0.004%
100%	11.1986	11.1991	11.1991	11.1985	11.1989	11.1990	0.6	0.005%
Load	1.8	1.7	1.8	1.6	1.9	1.9	$\Delta I(\text{mA})$	
Regulation	0.016%	0.015%	0.016%	0.014%	0.017%	0.017%		

2. Temperature drift, C.C mode

Conditions: Vin:100VAC
Iout:100%

Ta	0°C	25°C	50°C	Temp. Coefficient (0°C~50°C)	
Iout	11.1947	11.1979	11.2060	11.3 mA	20 ppm/°C

G600-2.8

1. Regulation - Line & Load, C.C mode (*)

Vo	Vin						Line Regulation	
	85VAC	100VAC	115VAC	200VAC	230VAC	265VAC		
0%	2.8003	2.8003	2.8003	2.8003	2.8003	2.8003	0.0	0.000%
25%	2.8003	2.8003	2.8003	2.8003	2.8003	2.8003	0.0	0.000%
50%	2.8006	2.8006	2.8006	2.8006	2.8006	2.8006	0.0	0.000%
75%	2.8006	2.8006	2.8006	2.8006	2.8006	2.8006	0.0	0.000%
100%	2.8008	2.8008	2.8008	2.8008	2.8008	2.8008	0.0	0.000%
Load	0.5	0.5	0.5	0.5	0.5	0.5	$\Delta I(\text{mA})$	
Regulation	0.018%	0.018%	0.018%	0.018%	0.018%	0.018%		

2. Temperature drift, C.C mode

Conditions: Vin:100VAC
Iout:100%

Ta	0°C	25°C	50°C	Temp. Coefficient (0°C~50°C)	
Iout	2.8006	2.8015	2.8029	2.3 mA	16 ppm/°C

Notes:

(*) Not including load regulation thermal drift effect.

(2). Output voltage and ripple voltage vs. input voltage

C.V mode

Conditions: Iout:100%

Ta: 0°C -----
 25°C -.-.-.-.-
 50°C _____

G10-170

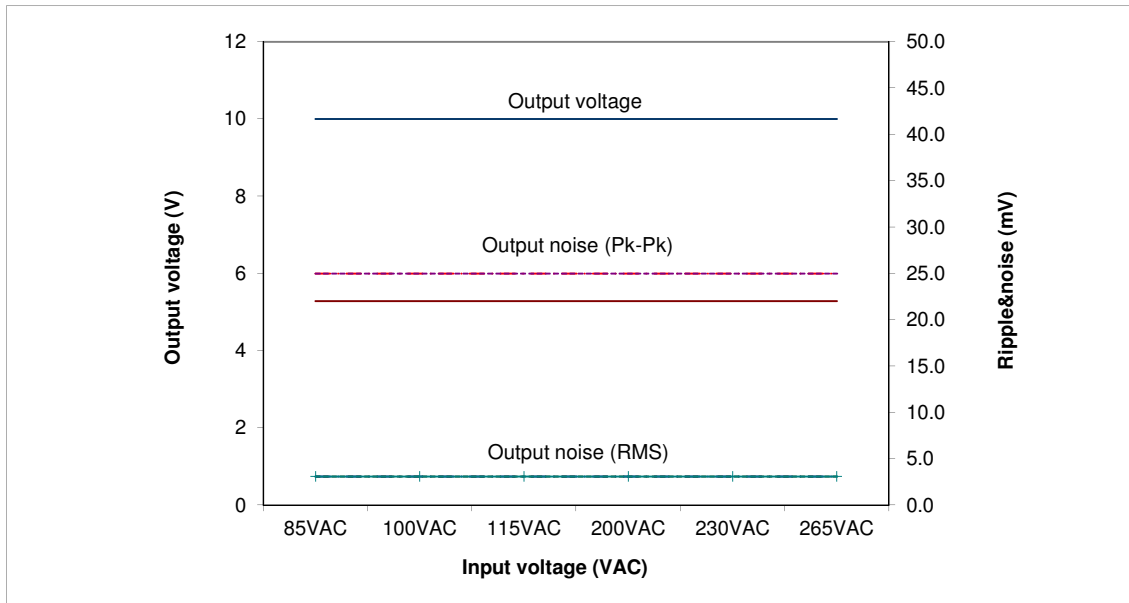

G60-28

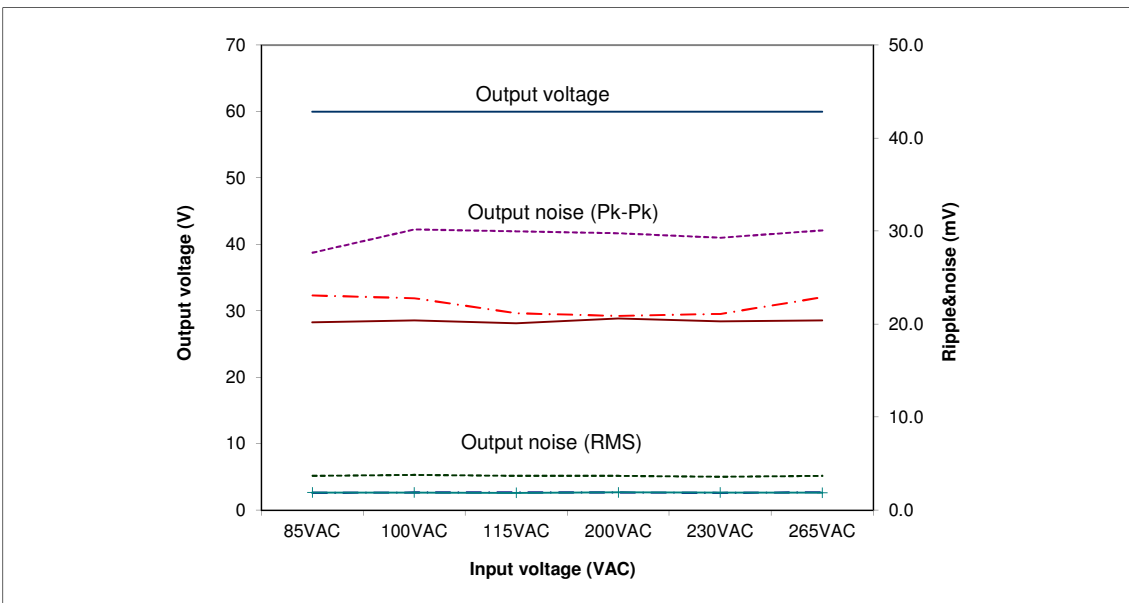

(2). Output voltage and ripple voltage vs. input voltage

C.V mode

Conditions: Iout:100%

Ta: 0°C -----
 25°C - - - - -
 50°C _____

G150-11.2

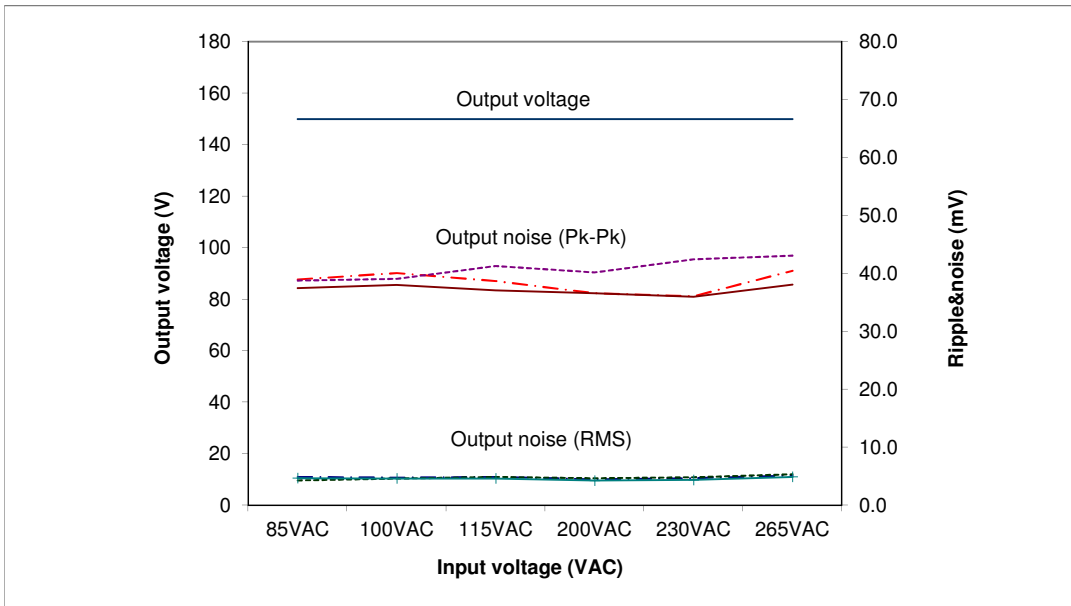

G600-2.8

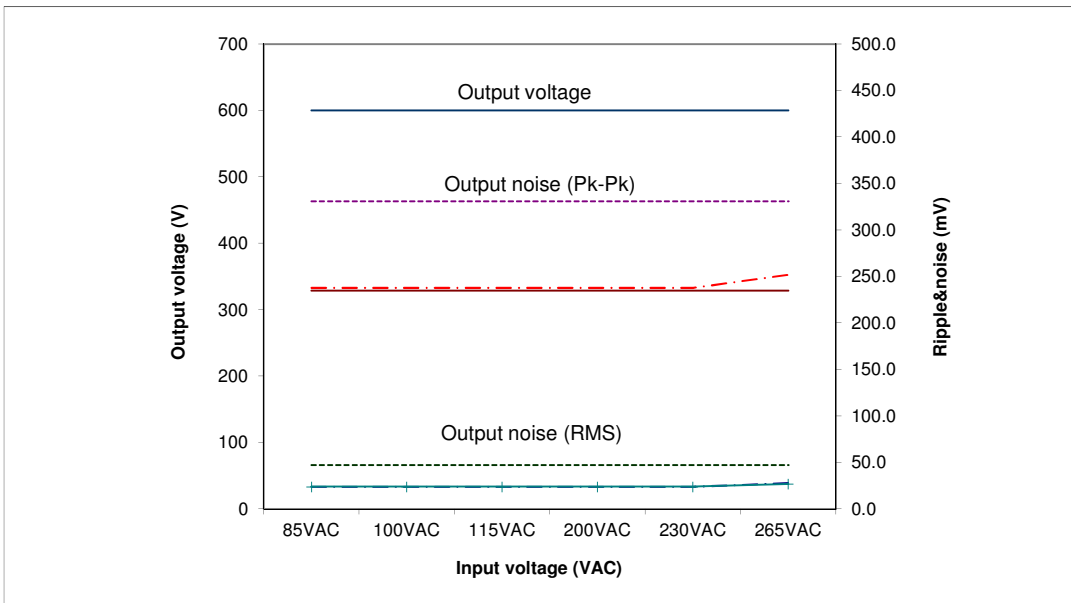

(3). Efficiency and Input current vs. Output current

G10-170

Conditions:
 Vin: 85~265 VAC
 Vout: 100%
 Ta: 25°C

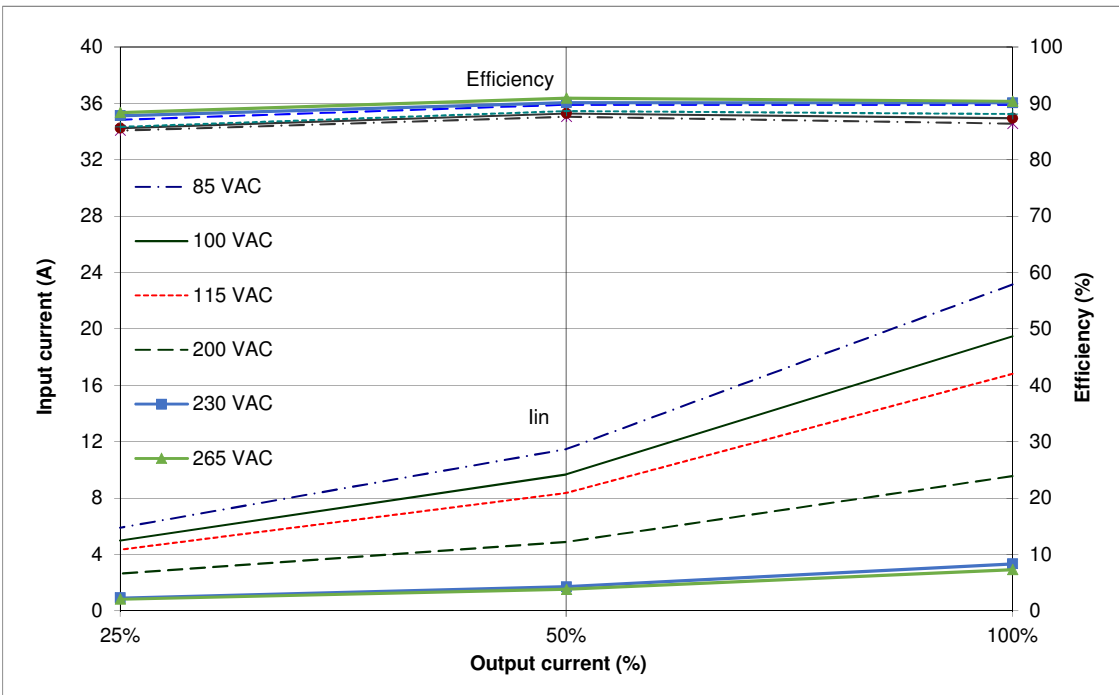

G60-28

Conditions:
 Vin: 85~265 VAC
 Vout: 100%
 Ta: 25°C

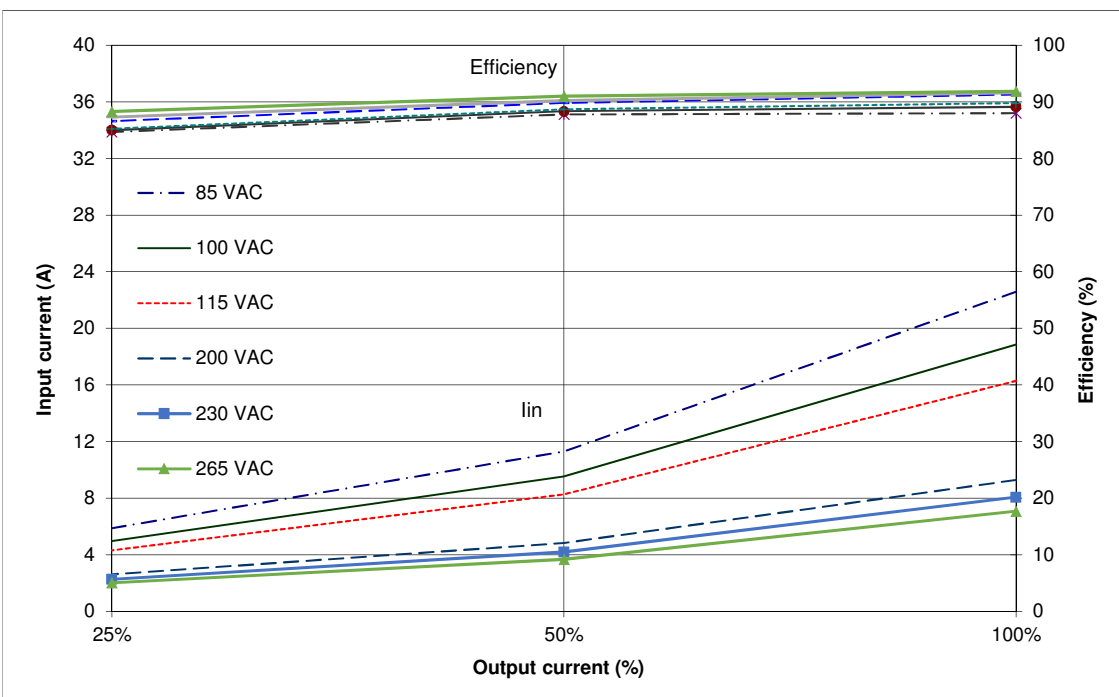

(3). Efficiency and Input current vs. Output current

G150-11.2

Conditions:

Vin: 85~265 VAC

Vout: 100%

Ta: 25°C

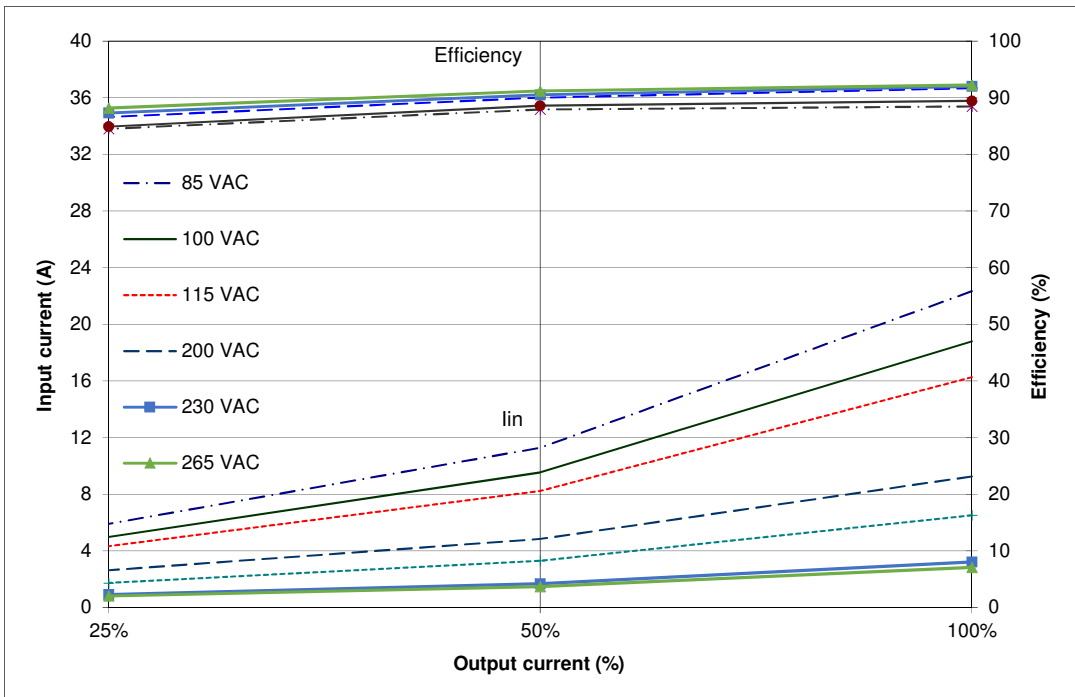

G600-2.8

Conditions:

Vin: 85~265 VAC

Vout: 100%

Ta: 25°C

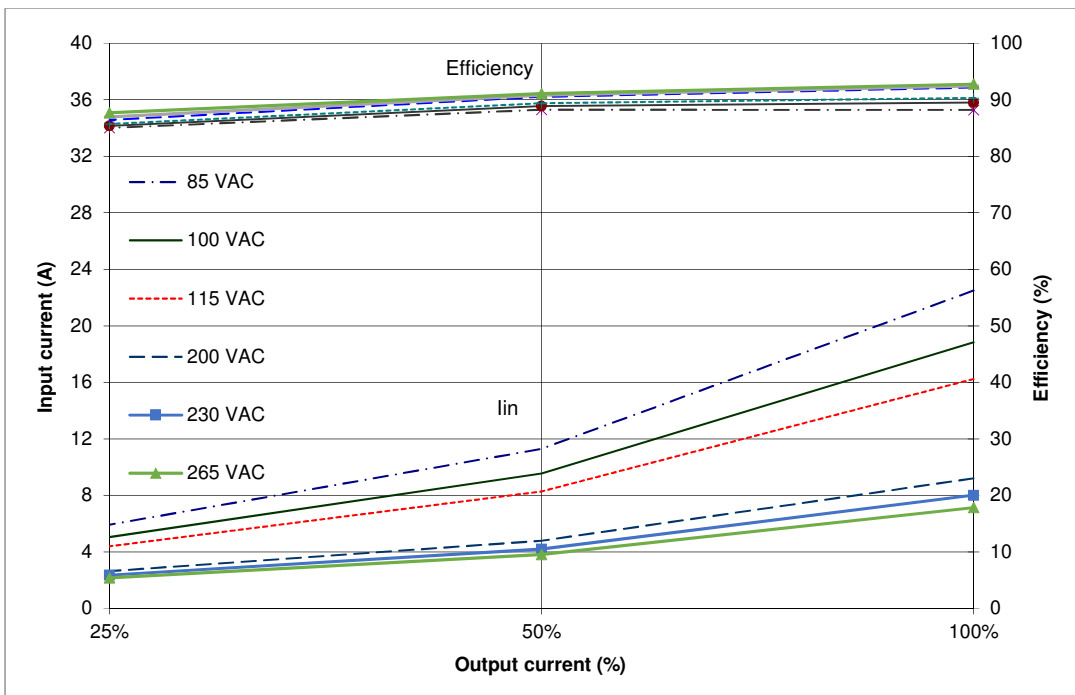

2.2 Warm up drift & stability

Conditions: Vin:100VAC

Vout: 100%

Iout: 100%

Ta = 25°C

G10-170 C.V mode

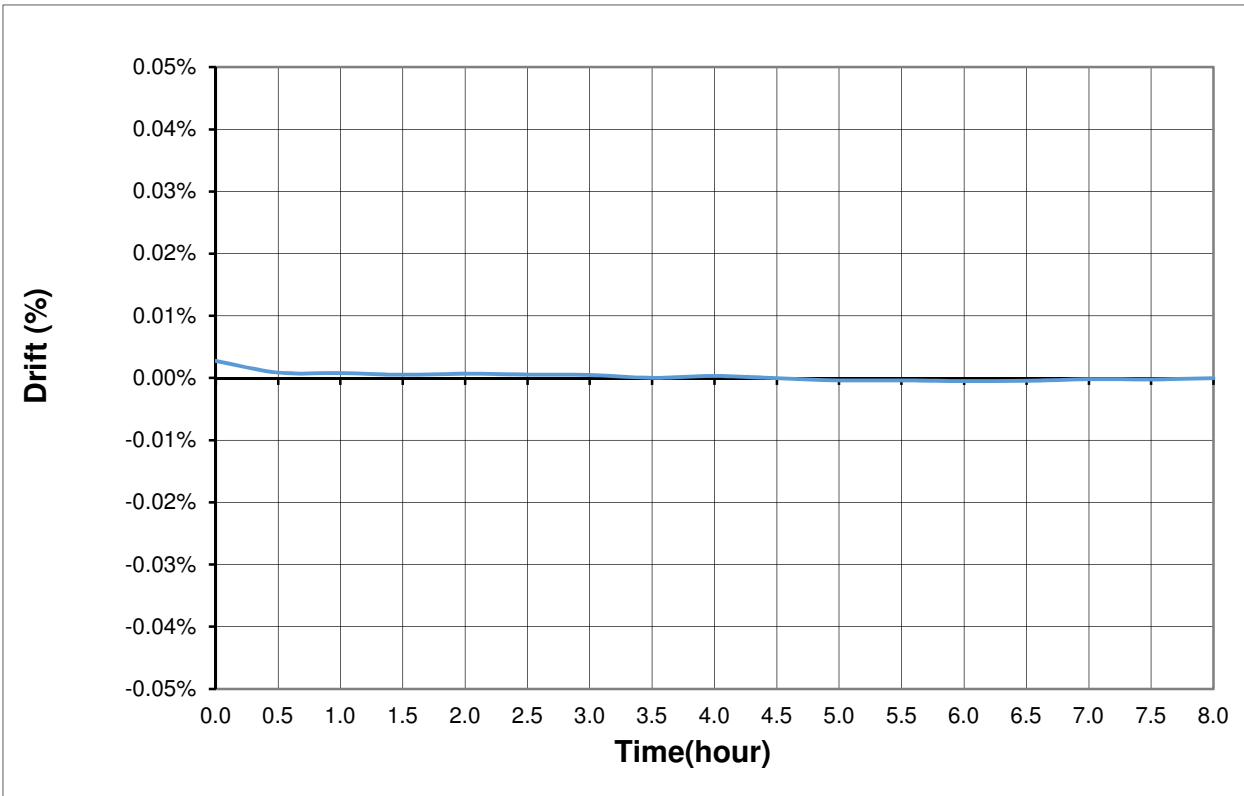

G10-170 C.C mode

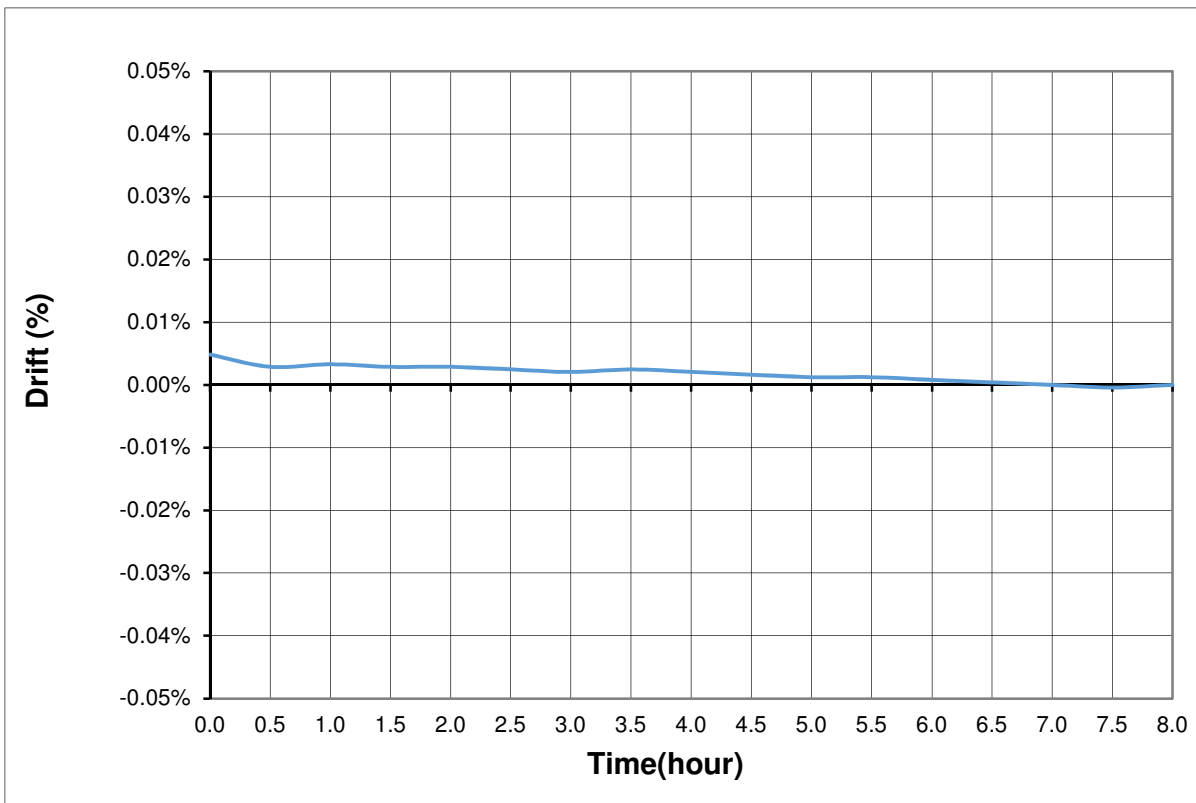

2.2 Warm up drift & stability

Conditions: Vin:100VAC

Vout: 100%

Iout: 100%

Ta = 25 °C

G60-28 C.V mode

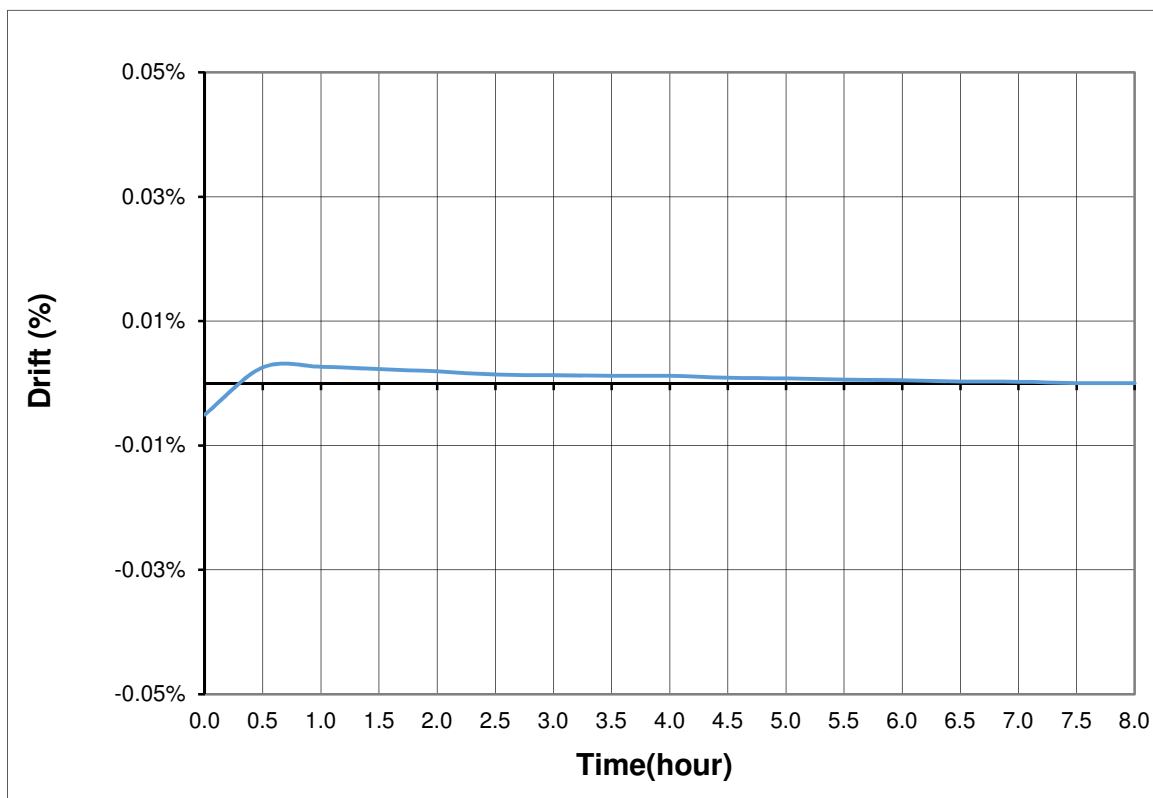

G60-28 C.C mode

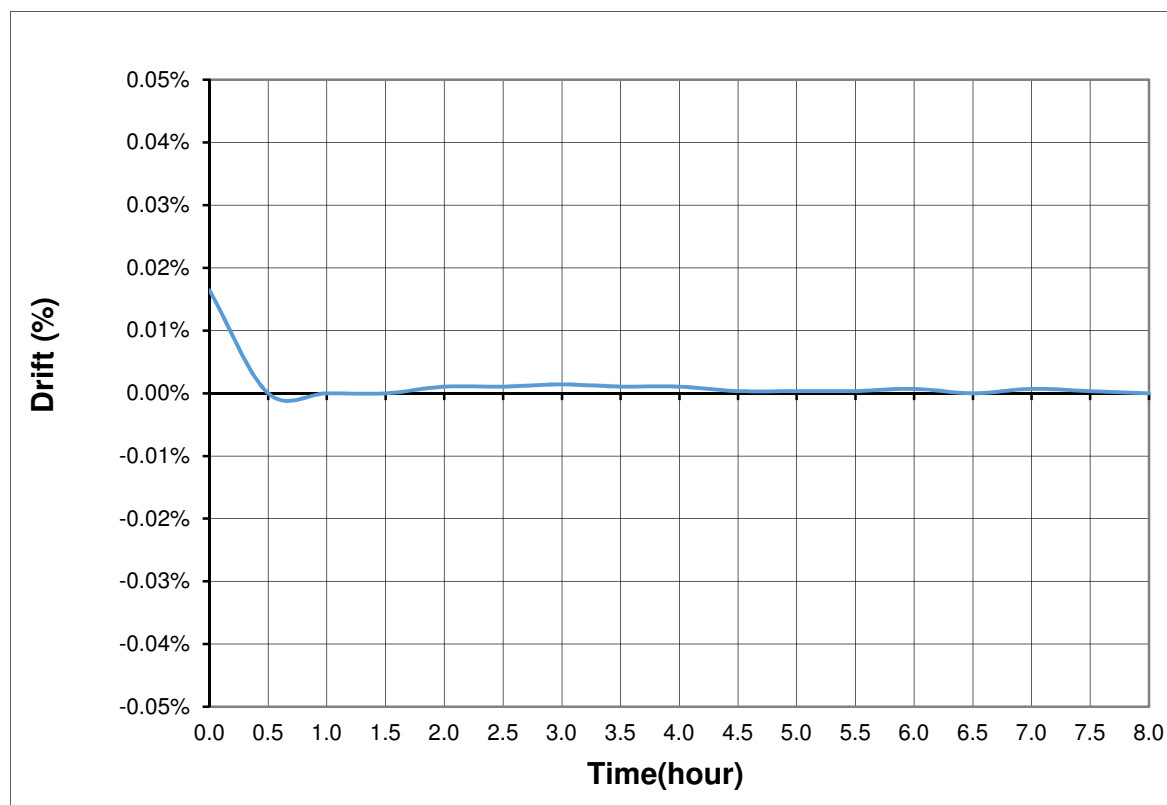

2.2 Warm up drift & stability

Conditions: Vin:100VAC

Vout: 100%

Iout: 100%

Ta = 25°C

G150-11.2 C.V mode

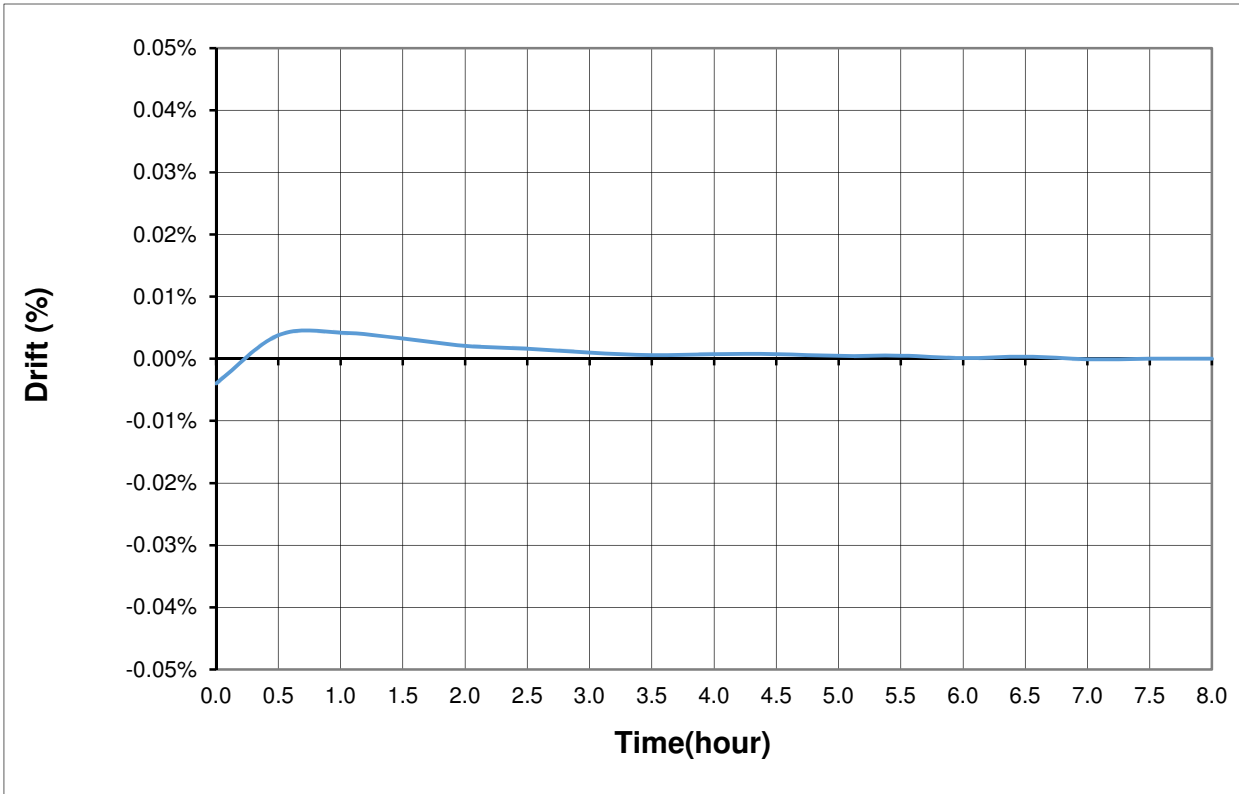

G150-11.2 C.C mode

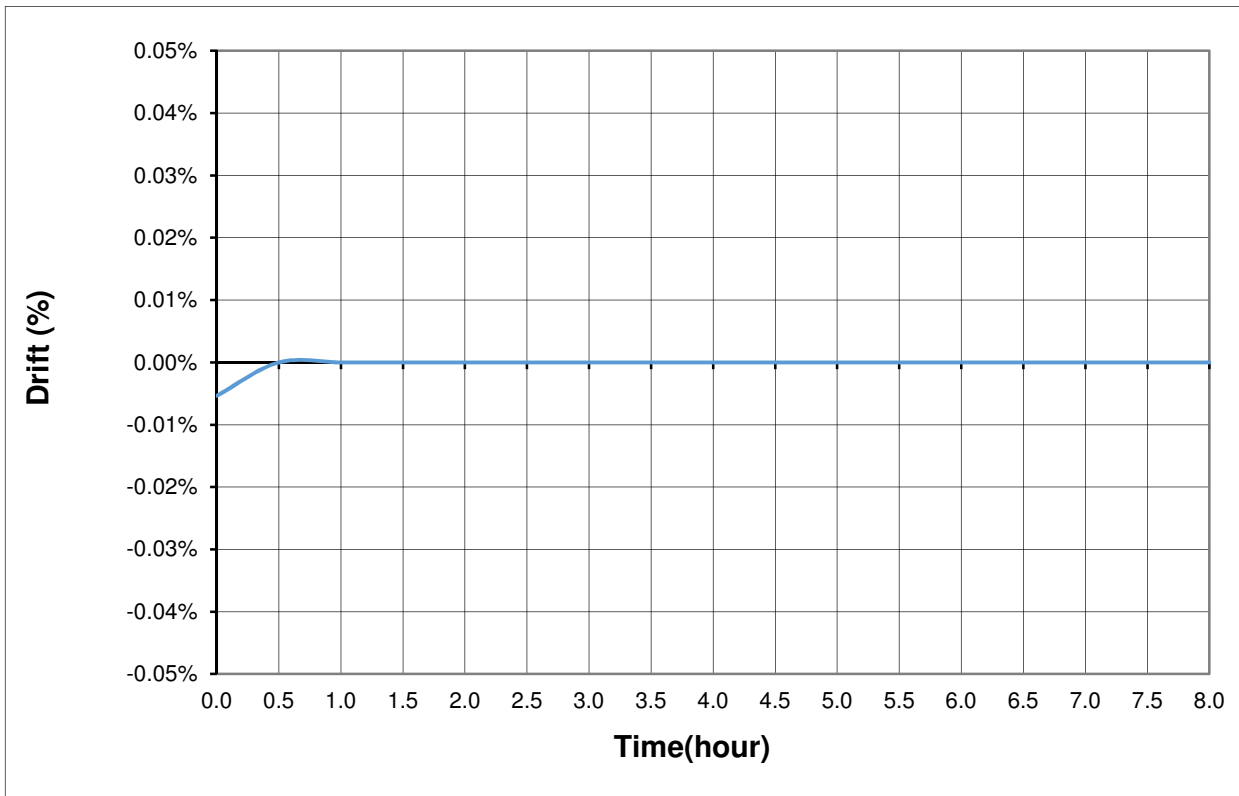

2.2 Warm up drift & stability

Conditions: Vin:100VAC

Vout: 100%

Iout: 100%

Ta = 25°C

G600-2.8 C.V mode

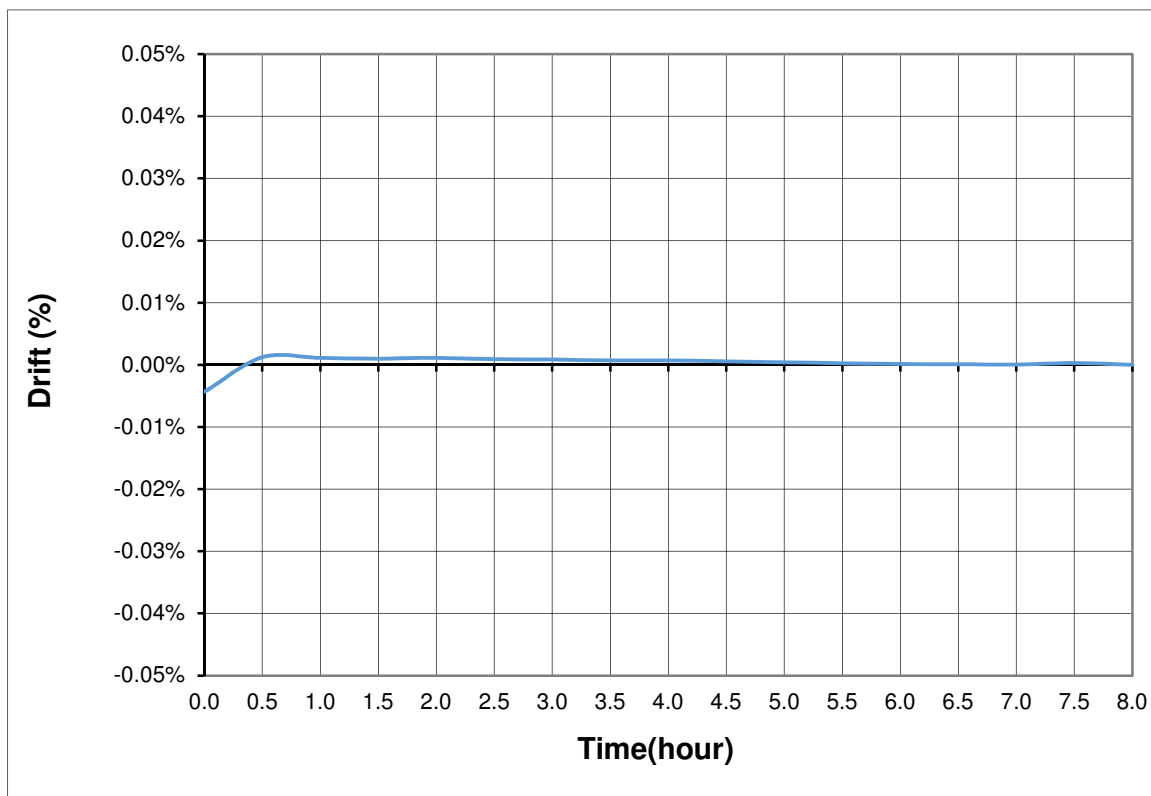

G600-2.8 C.C mode

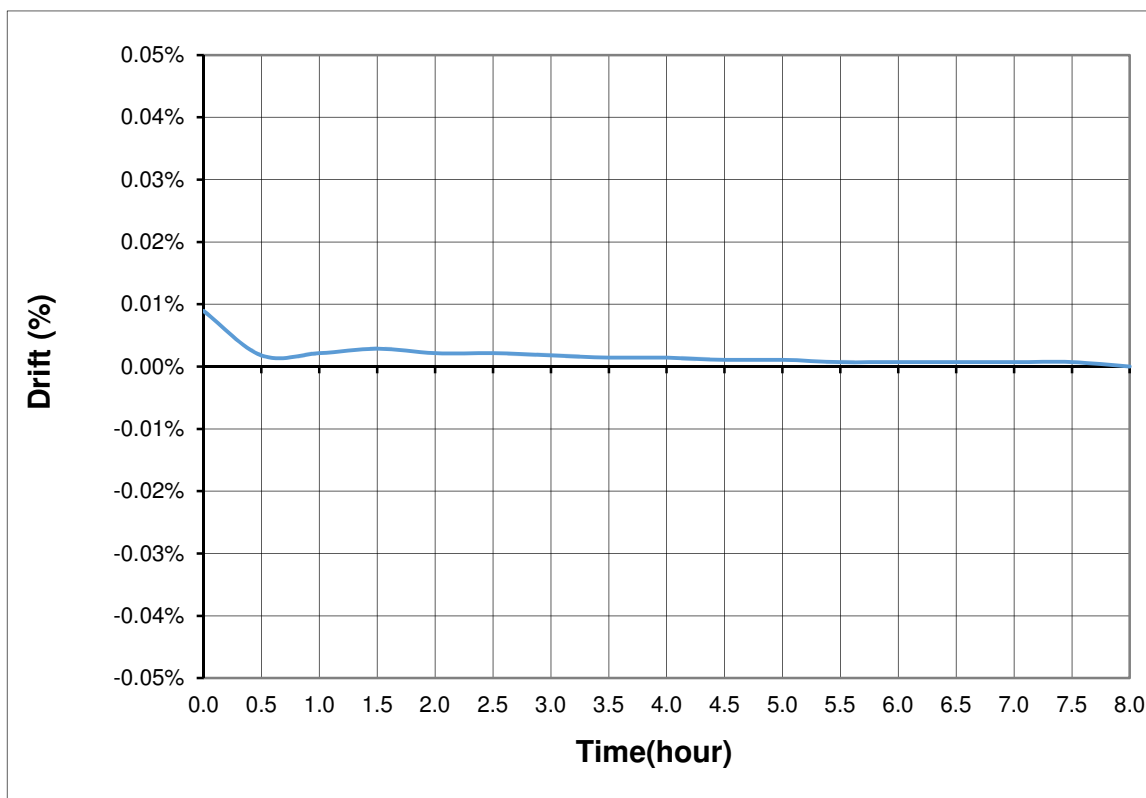

2.3 Over voltage protection (OVP) characteristic

Conditions: Vin:100VAC

Iout: 0%

Ta = 25°C

G10-170

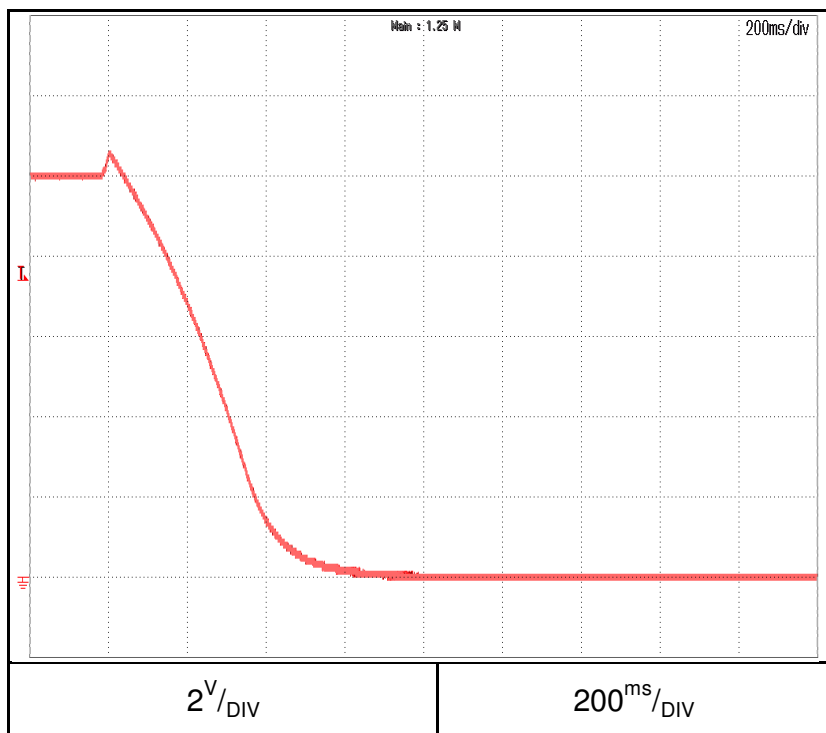

OVP setting:10.5V

G60-28

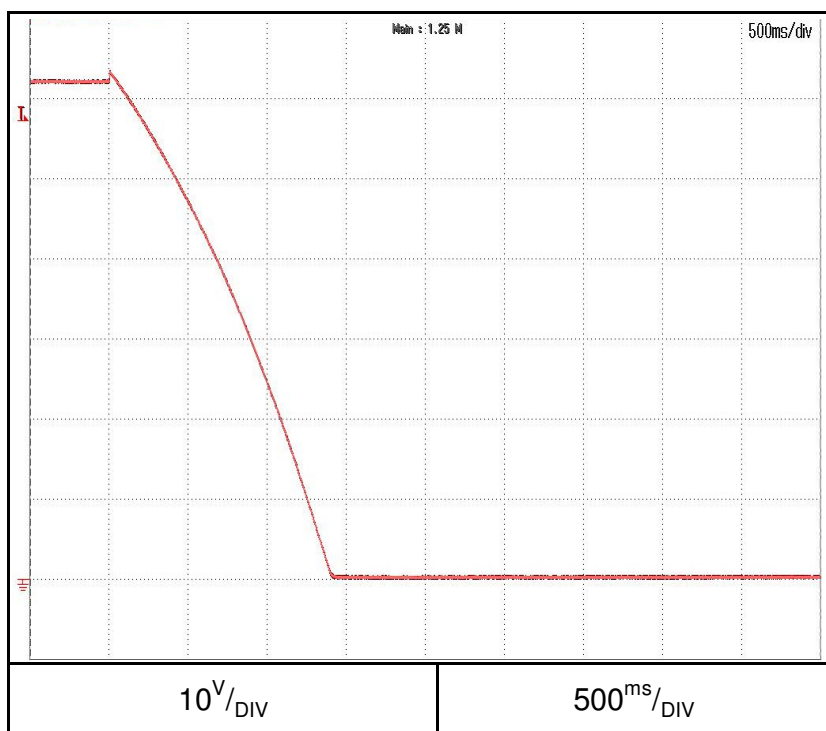

OVP setting:63V

2.3 Over voltage protection (OVP) characteristic

Conditions: Vin:100VAC

Iout: 0%

Ta = 25°C

G150-11.2

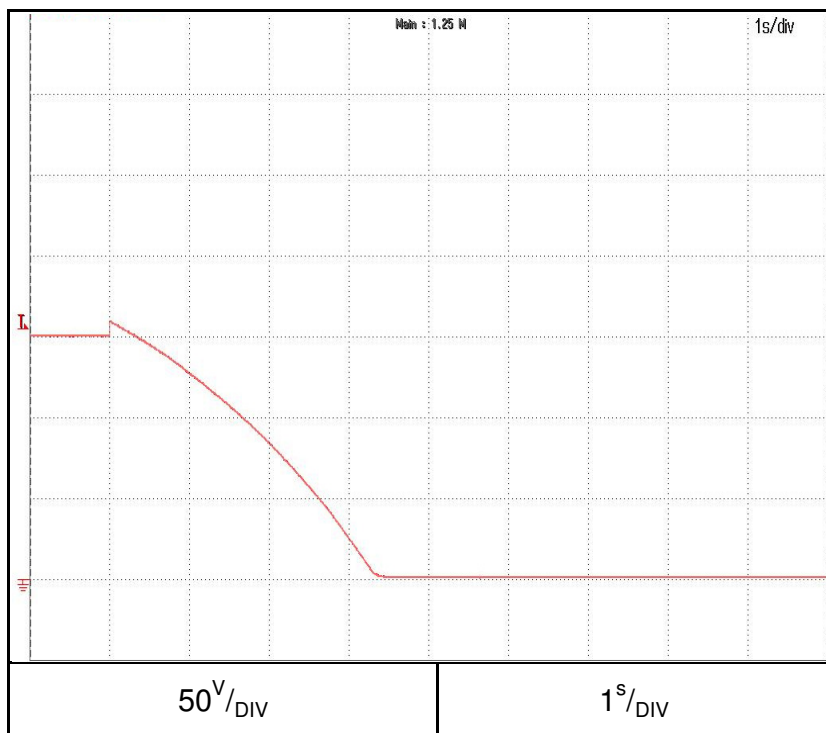

OVP setting:157.5V

G600-2.8

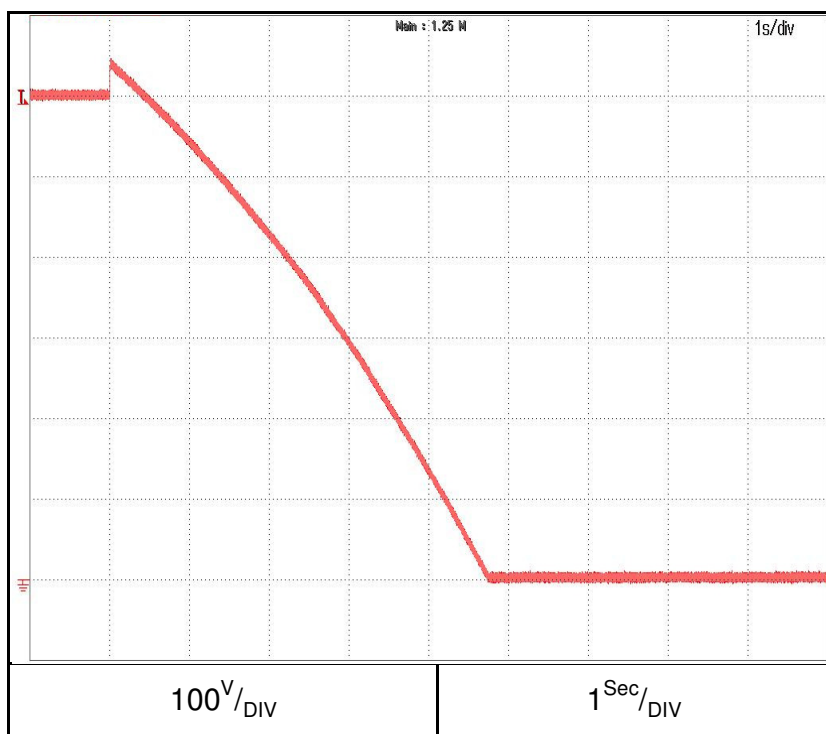

OVP setting:630V

2.4 ON/OFF Output rise characteristics

C.V mode

Conditions: Vin: 100VAC

Vout: 100%

Iout: 0%

Iset=105%

Ta = 25°C

G10-170

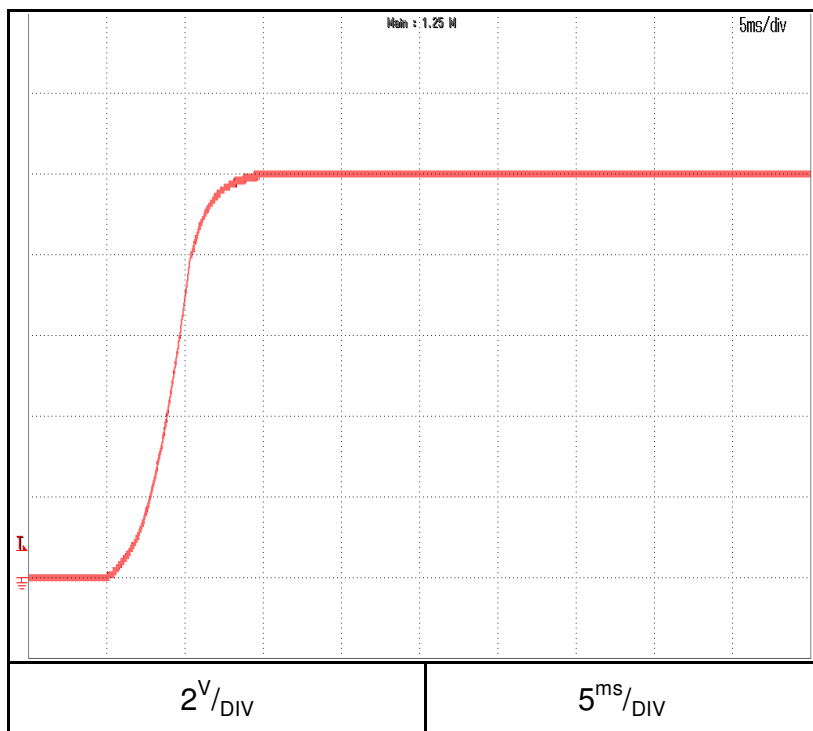

G60-28

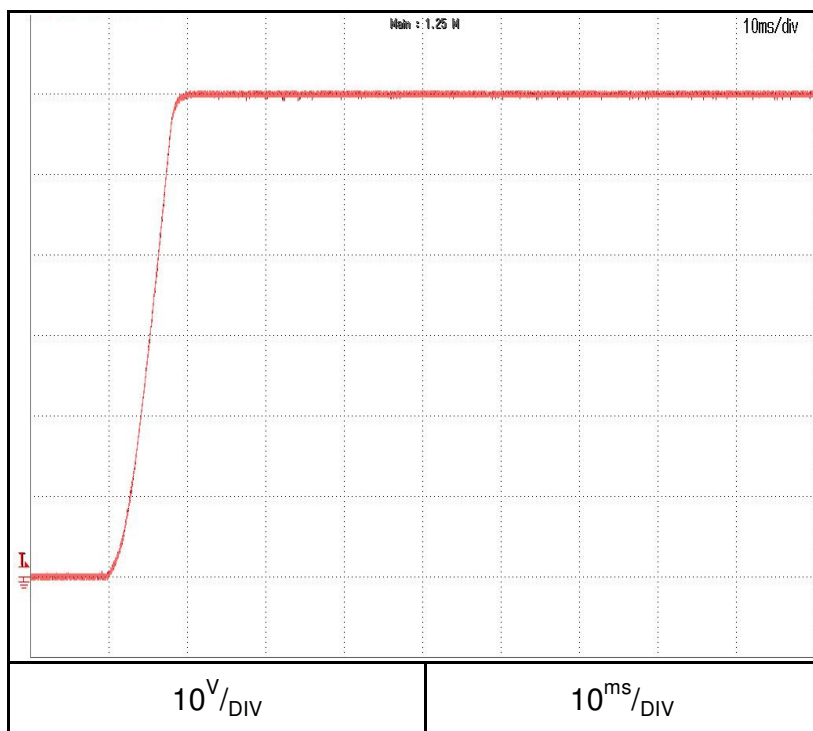

2.4 ON/OFF Output rise characteristics

C.V mode

Conditions: Vin: 100VAC

Vout: 100%

Iout: 0%

Iset=105%

Ta = 25 °C

G150-11.2

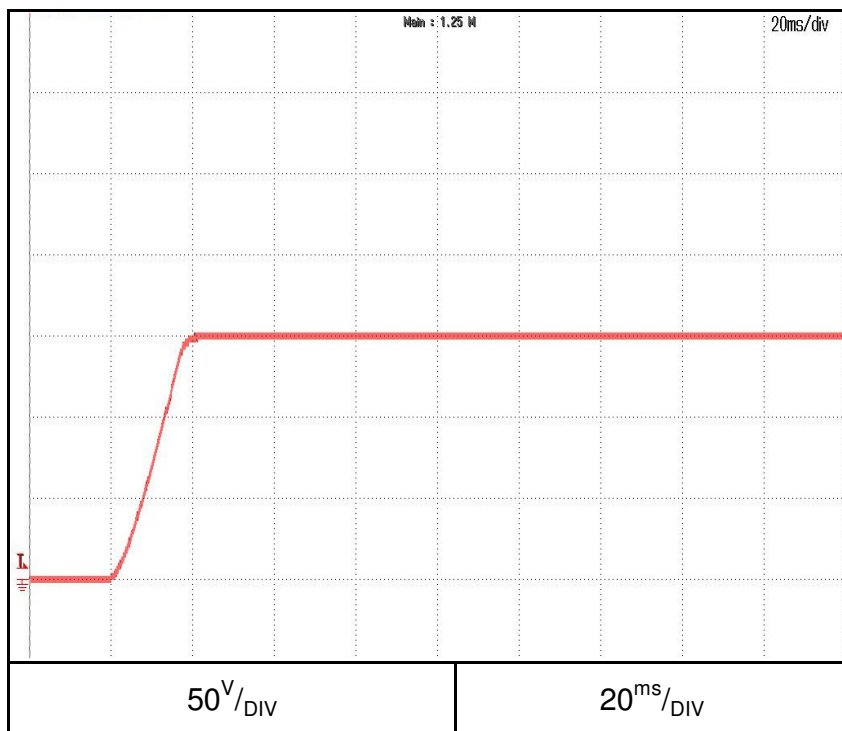

G600-2.8

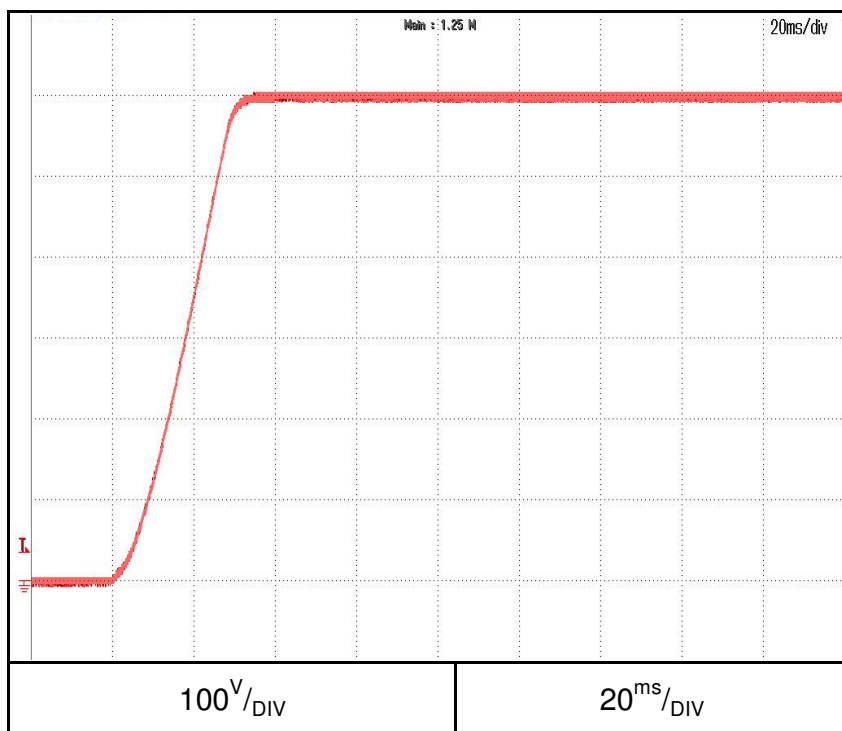

2.4 ON/OFF Output rise characteristics

C.V mode

Conditions: Vin: 100VAC

Vout: 100%

Iout: 100%

Iset=105%

Load: CR

Ta = 25°C

G10-170

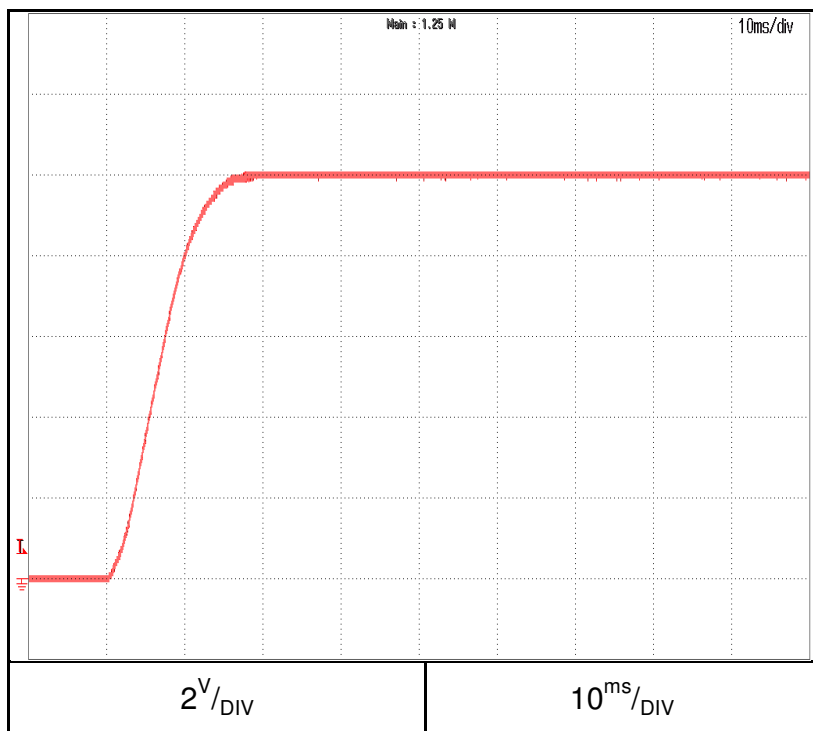

G60-28

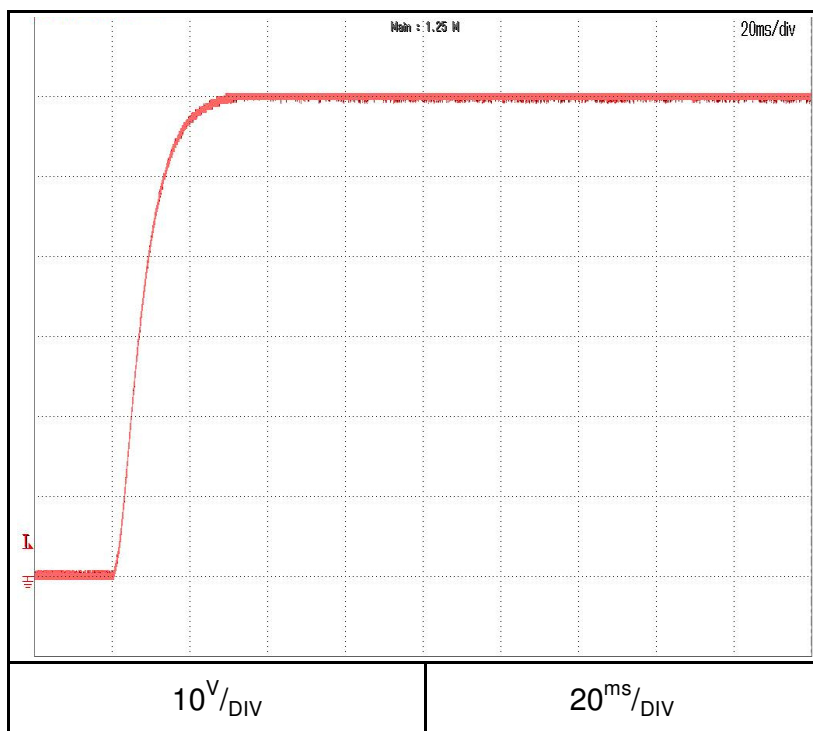

2.4 ON/OFF Output rise characteristics

C.V mode

Conditions: Vin: 100VAC

Vout: 100%

Iout: 100%

Iset=105%

Load: CR

Ta = 25°C

G150-11.2

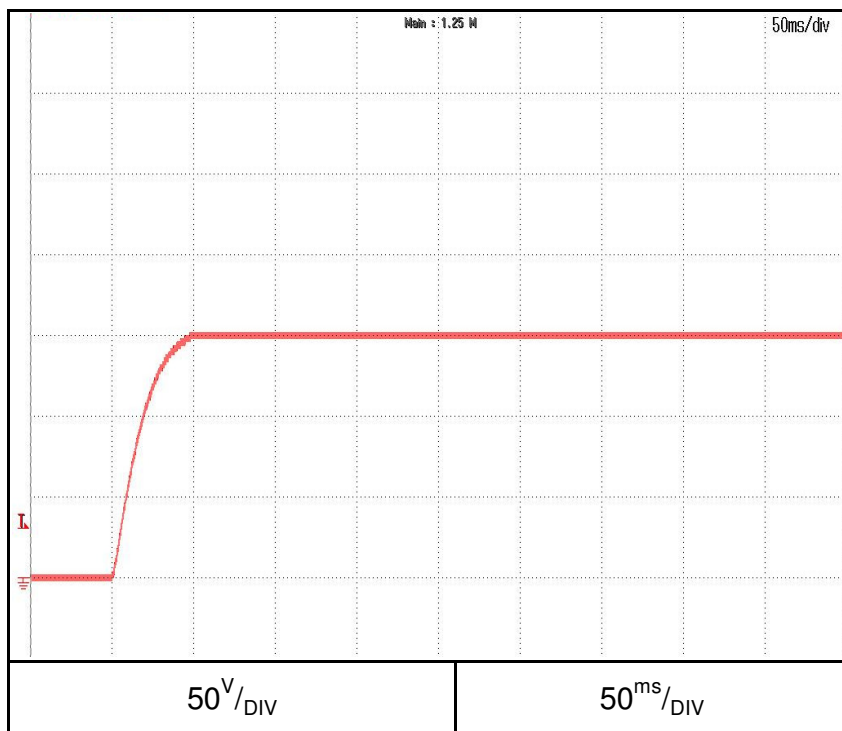

G600-2.8

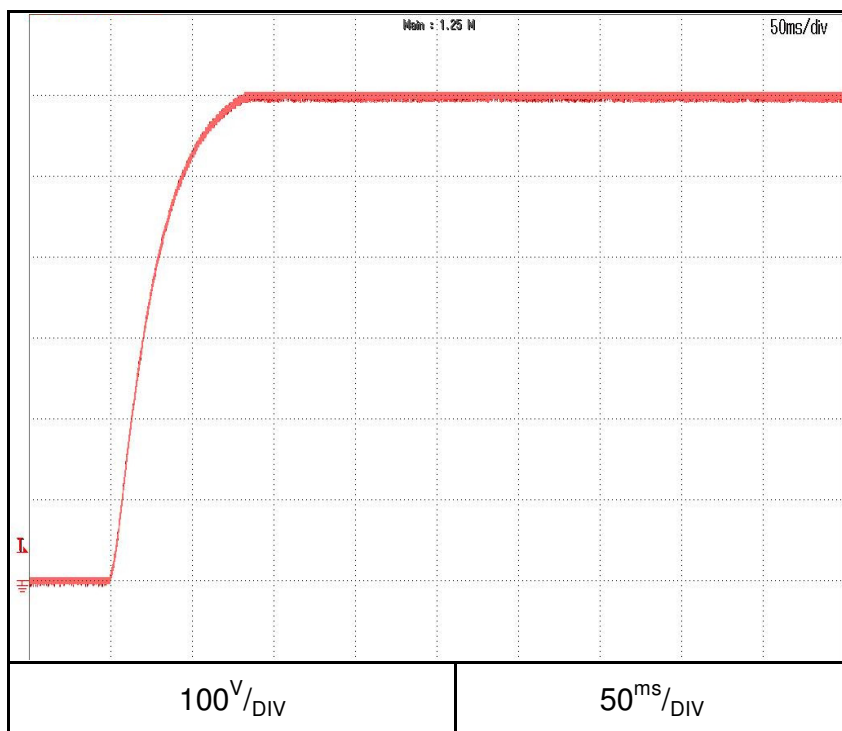

2.4 ON/OFF Output rise characteristics

C.C mode

Conditions: Vin: 100VAC

Vout: 100%

Iout: 100%

Vset=105%

Load: CR

Ta = 25°C

G10-170

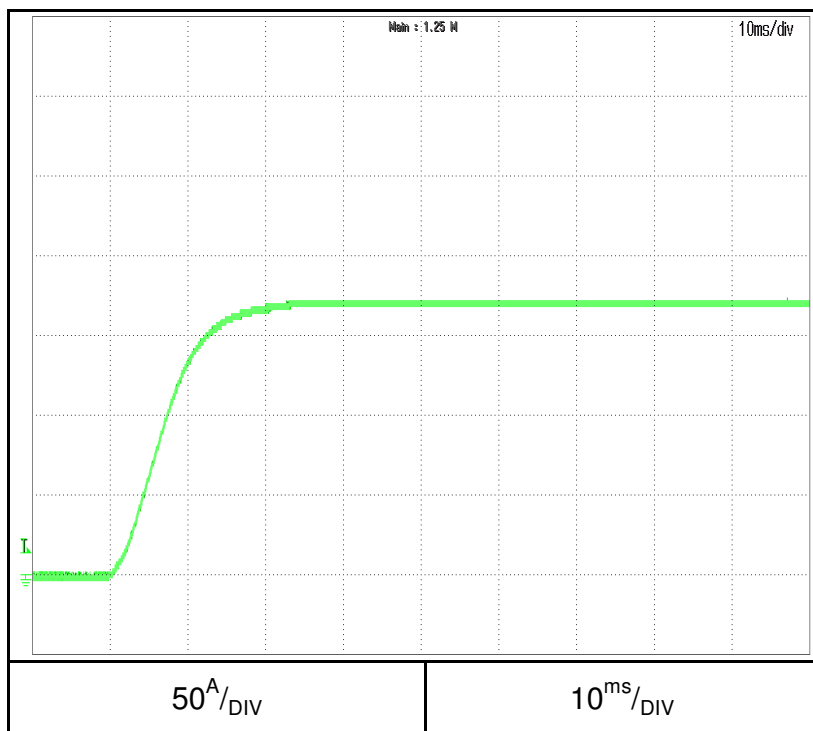

G60-28

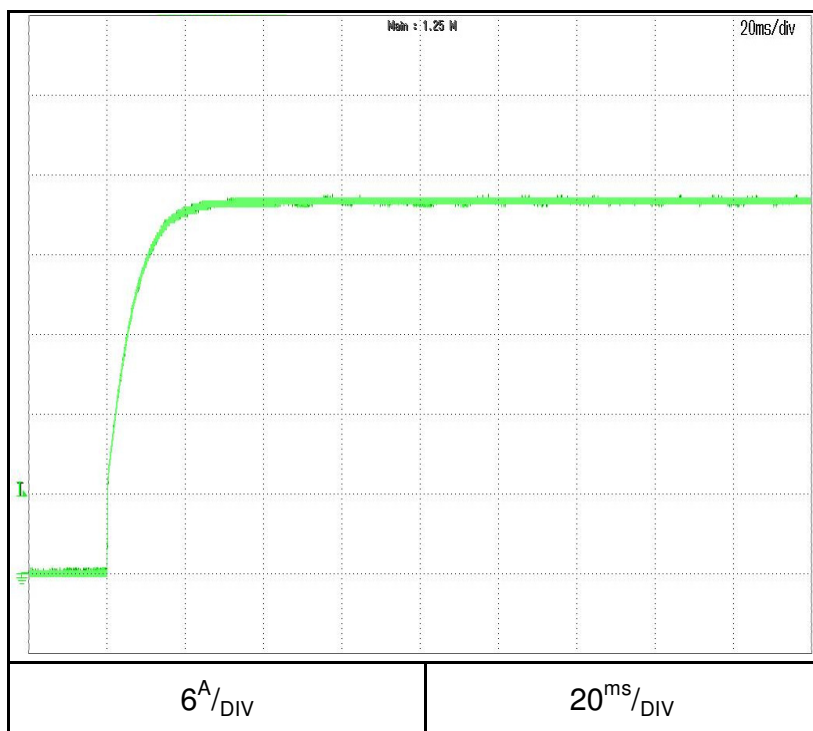

2.4 ON/OFF Output rise characteristics

C.C mode

Conditions: Vin: 100VAC

Vout: 100%

Iout: 100%

Vset=105%

Load: CR

Ta = 25°C

G150-11.2

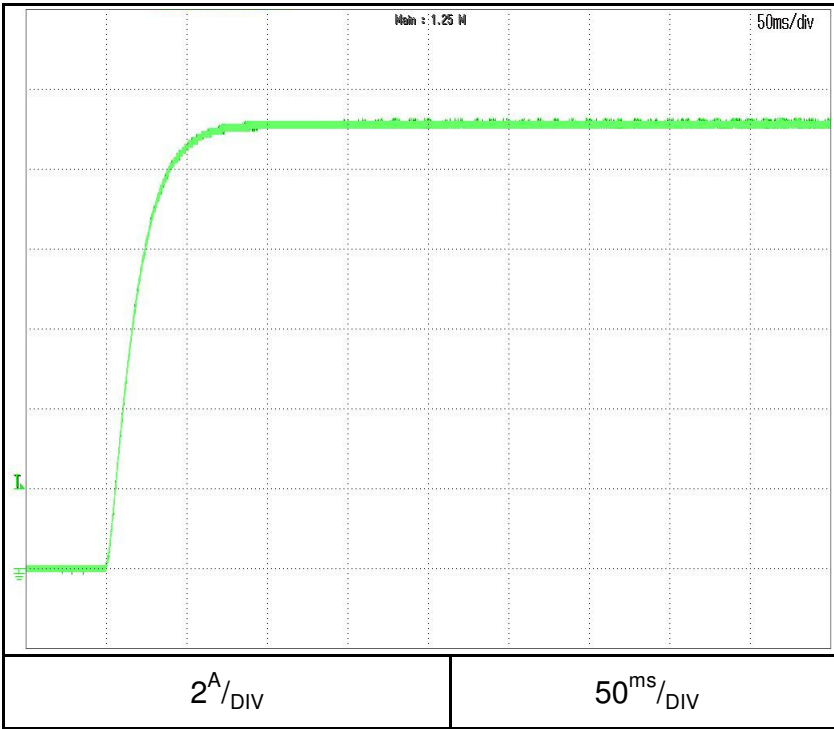

G600-2.8

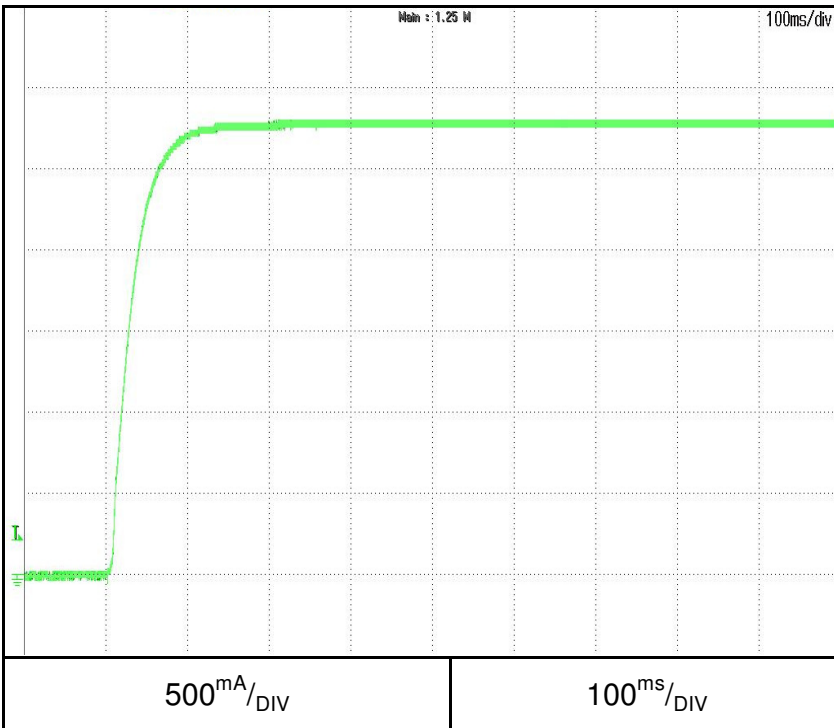

2.4 ON/OFF Output rise characteristics

C.C mode

Conditions: Vin: 100VAC

Iout: 100%

Vset=105%

shorted output

Ta = 25 °C

G10-170

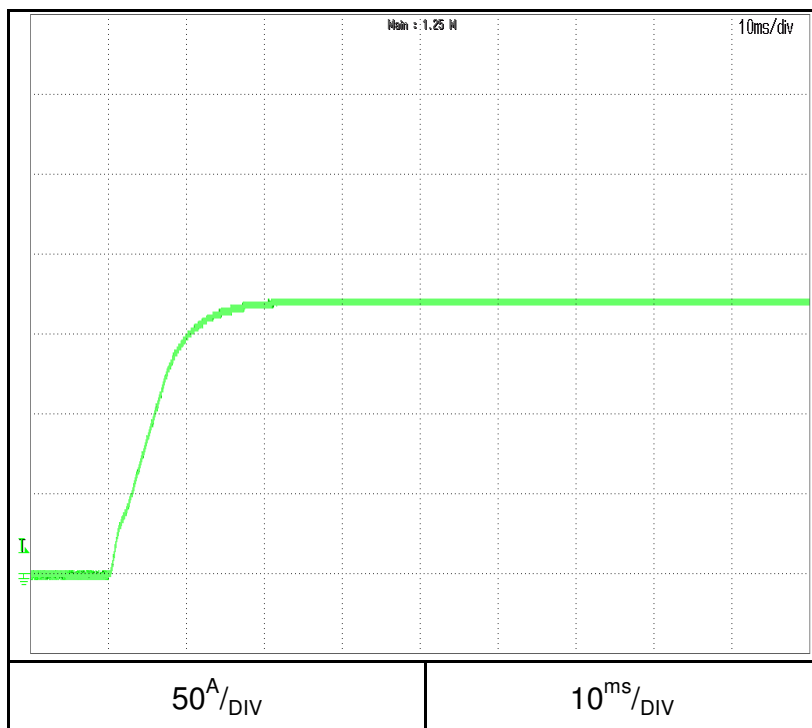

G60-28

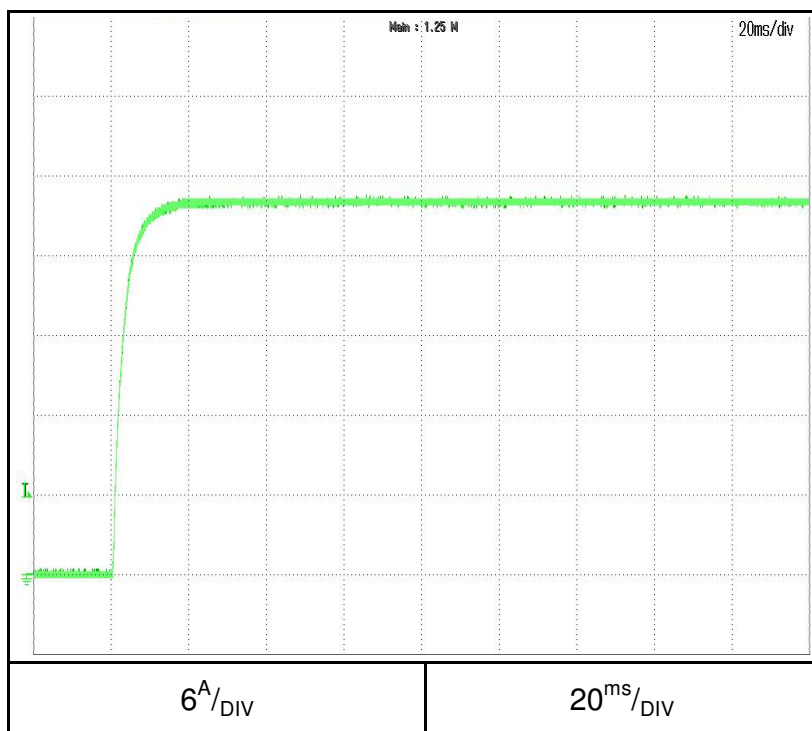

2.4 ON/OFF Output rise characteristics

C.C mode

Conditions: Vin: 100VAC

Iout: 100%

Vset=105%

shorted output

Ta = 25°C

G150-11.2

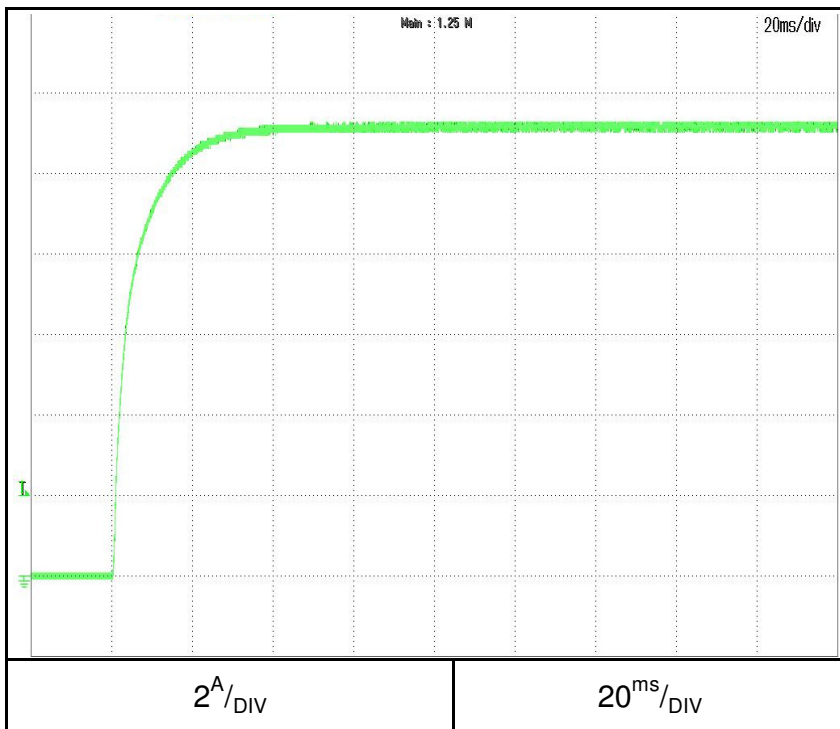

G600-2.8

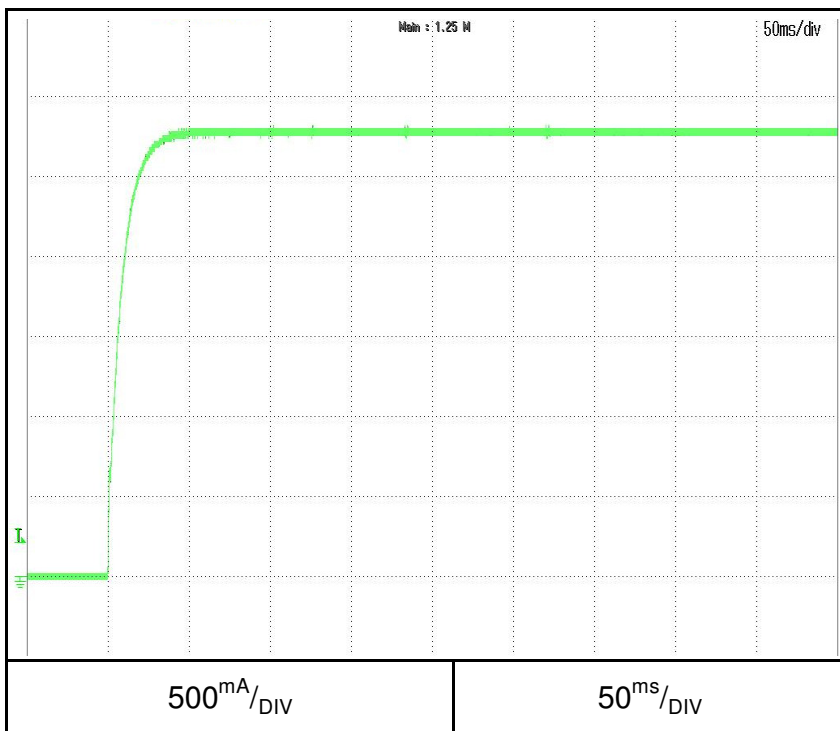

2.5 ON/OFF Output fall characteristics

C.V mode

Conditions: Vin: 100VAC

Vout: 100%

Iout: 0%

Ta = 25°C

G10-170

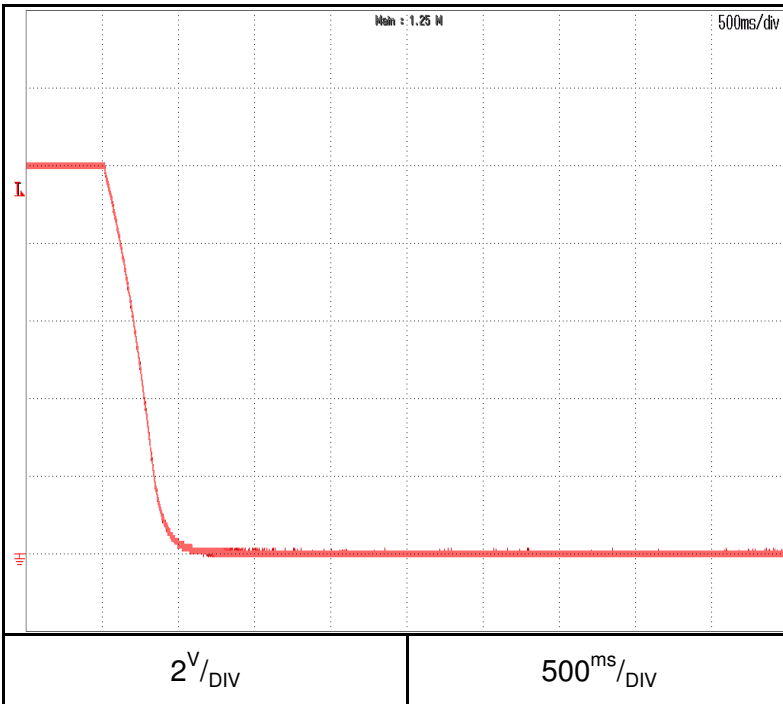

G60-28

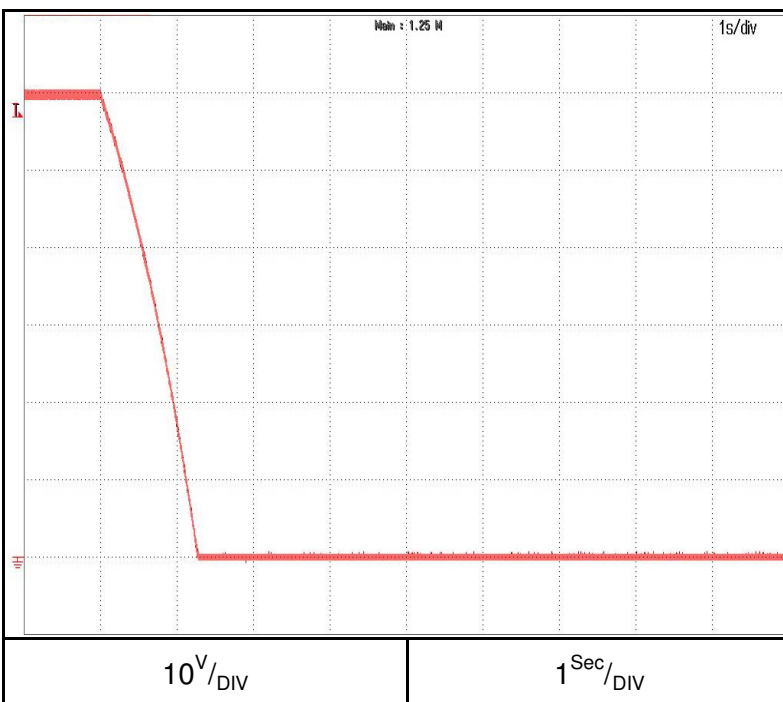

2.5 ON/OFF Output fall characteristics

C.V mode

Conditions: Vin: 100VAC

Vout: 100%

Iout: 0%

Ta = 25°C

G150-11.2

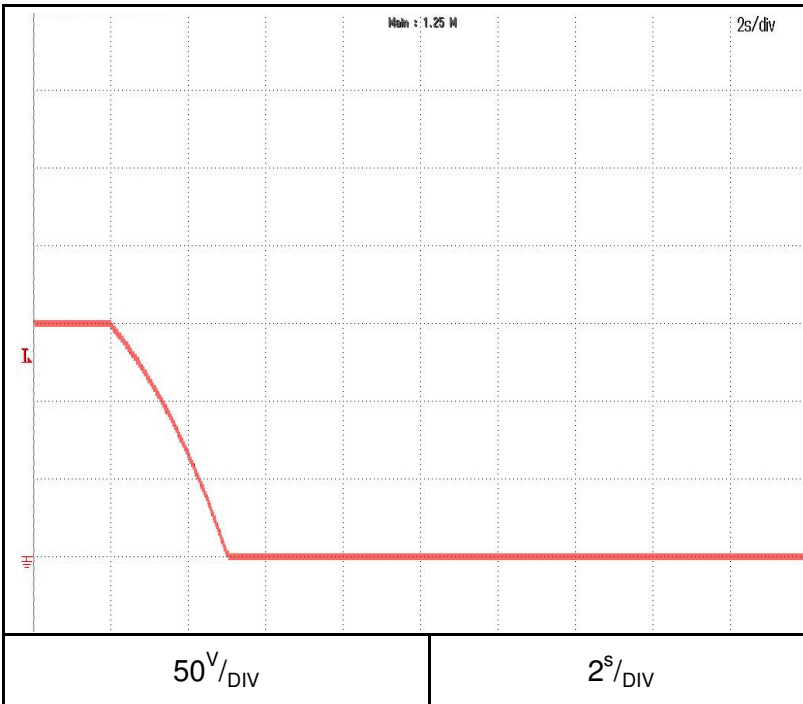

G600-2.8

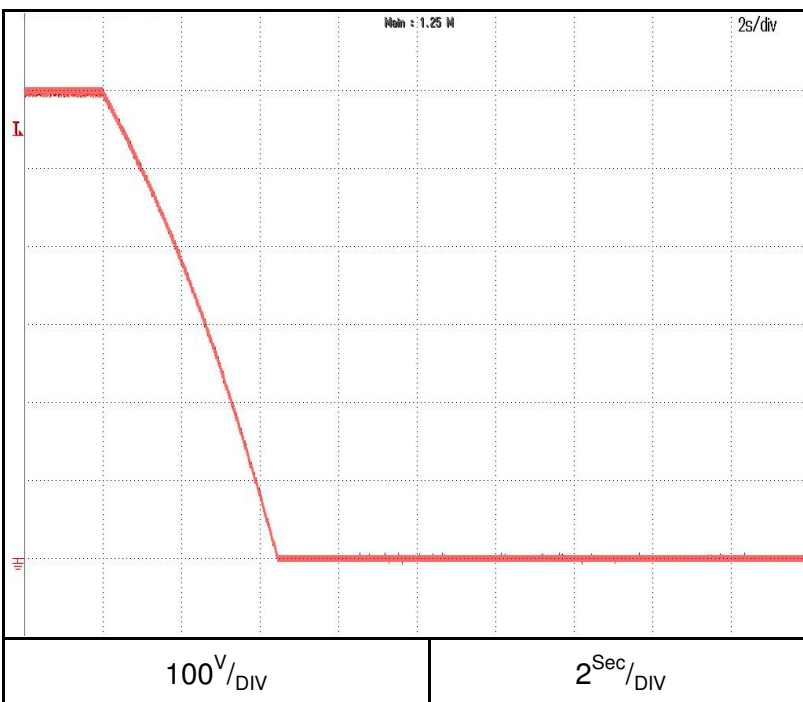

2.5 ON/OFF Output fall characteristics

C.V mode

Conditions: Vin: 100VAC

Vout: 100%

Iout: 100%

Load: CR

Ta = 25°C

G10-170

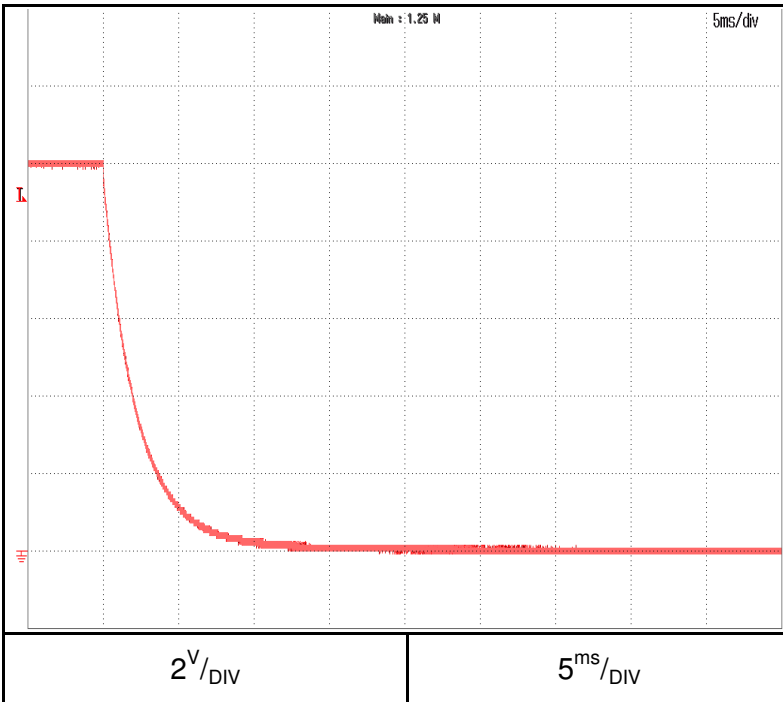

G60-28

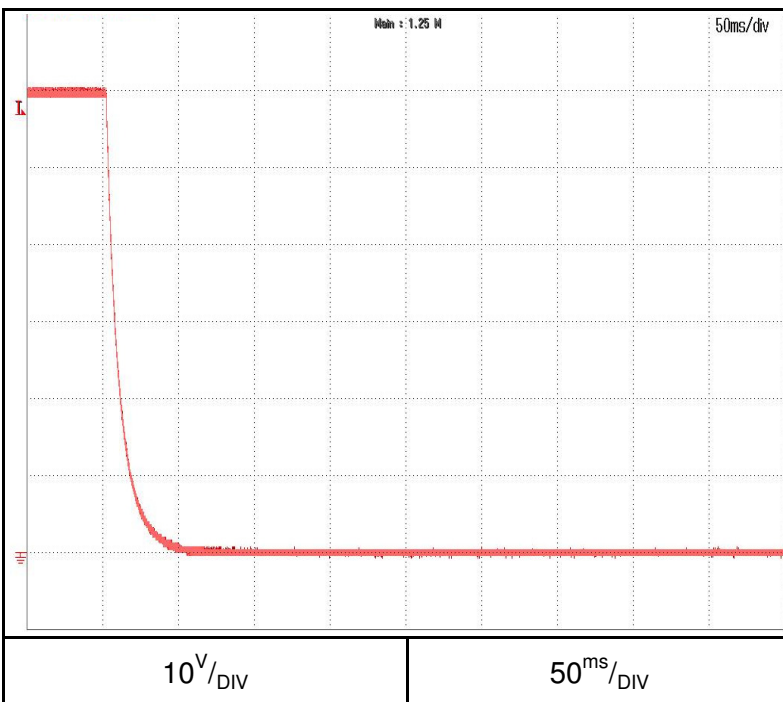

2.5 ON/OFF Output fall characteristics

C.V mode

Conditions: Vin: 100VAC

Vout: 100%

Iout: 100%

Load: CR

Ta = 25°C

G150-11.2

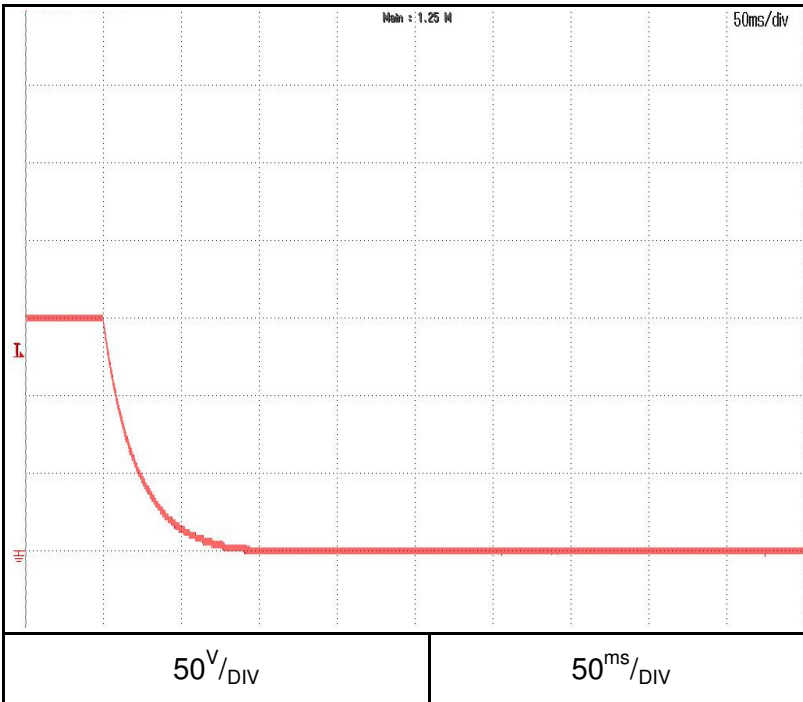

G600-2.8

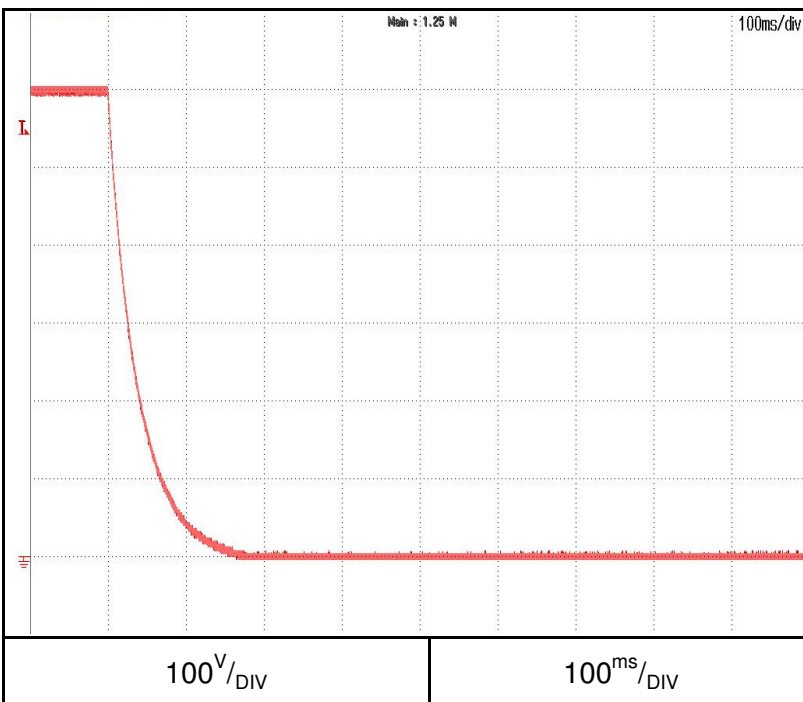

2.5 ON/OFF Output fall characteristics

C.C mode

Conditions: Vin: 100VAC

Vout: 100%

Iout: 100%

Load: CR

Ta = 25°C

G10-170

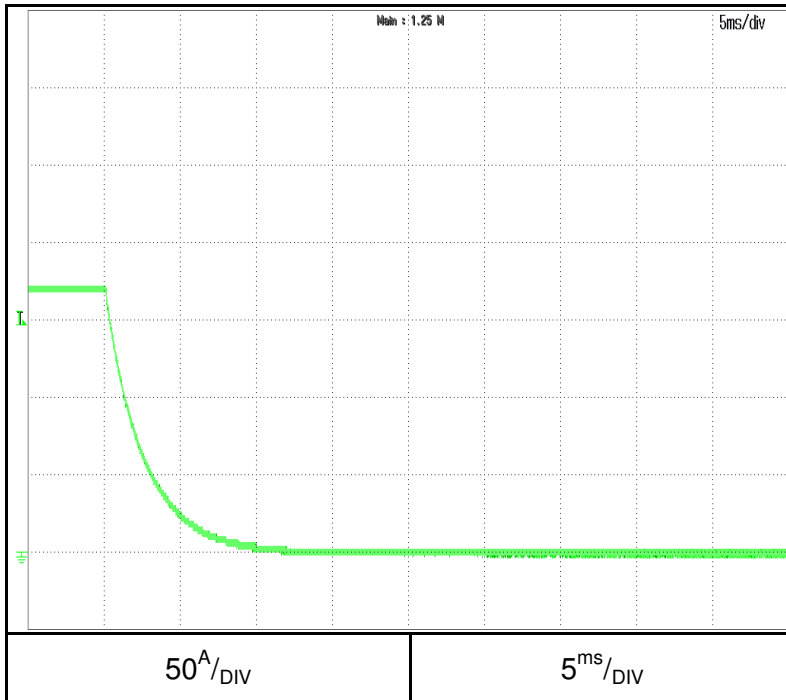

G60-28

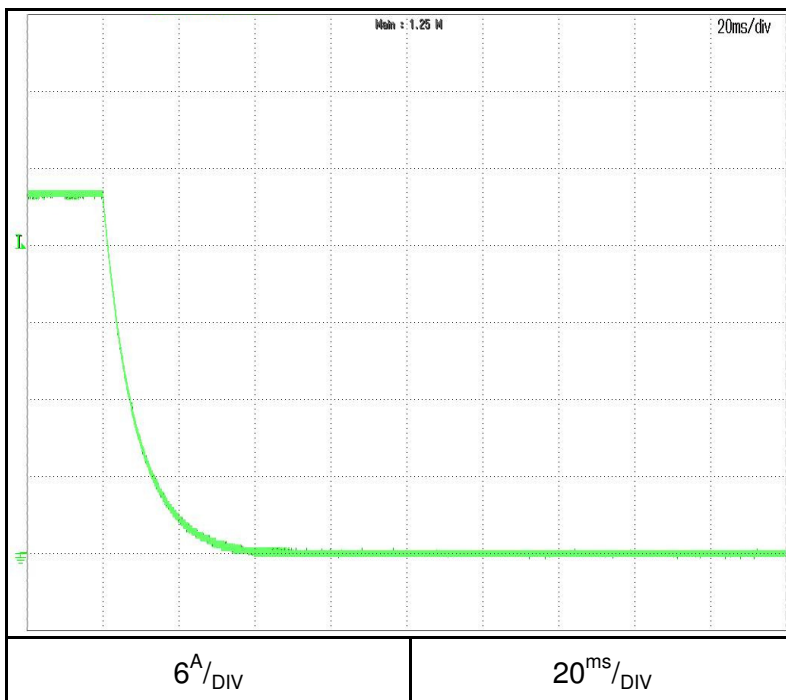

2.5 ON/OFF Output fall characteristics

C.C mode

Conditions: Vin: 100VAC

Vout: 100%

Iout: 100%

Load: CR

Ta = 25 °C

G150-11.2

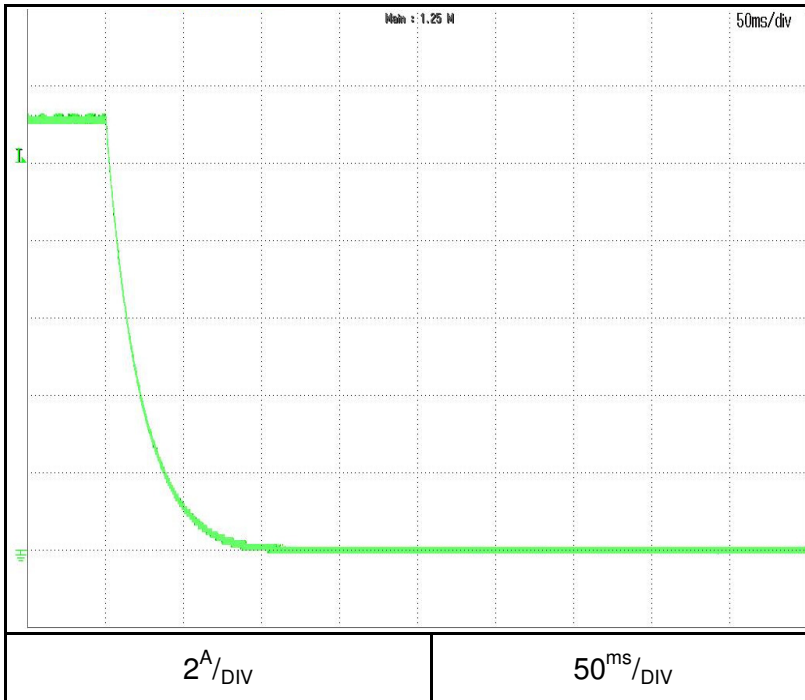

G600-2.8

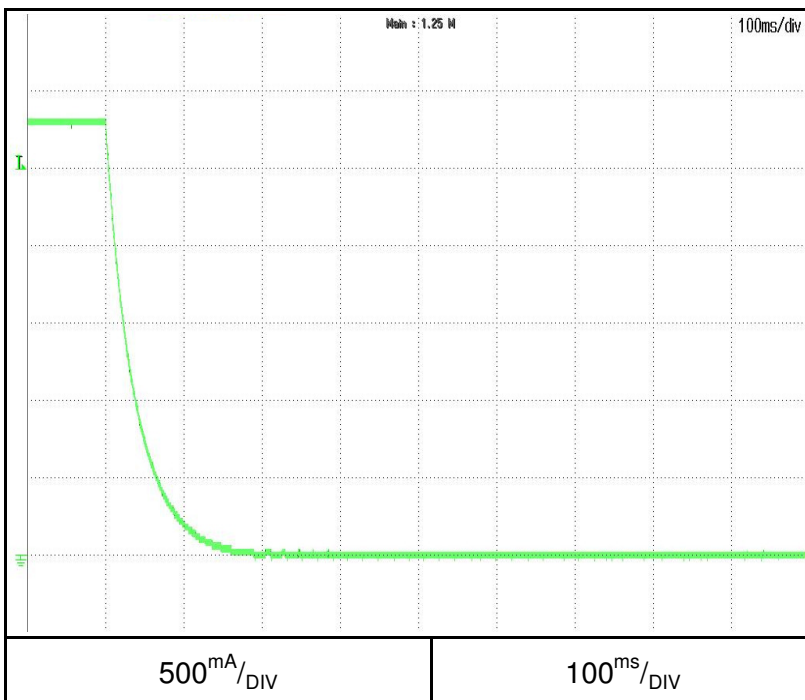

2.5 ON/OFF Output fall characteristics

C.C mode

Conditions: Vin: 100VAC

Iout: 100%

shorted output

Ta = 25°C

G10-170

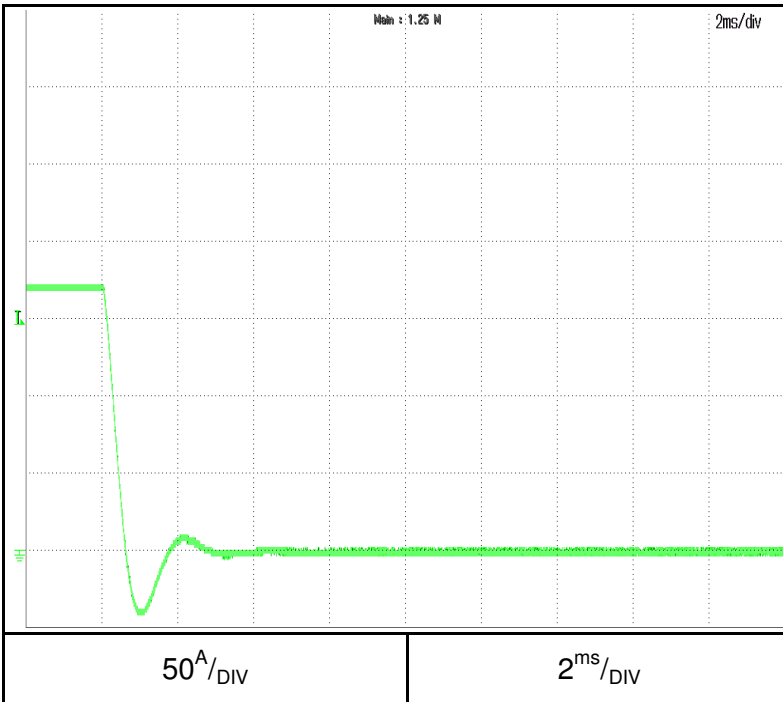

G60-28

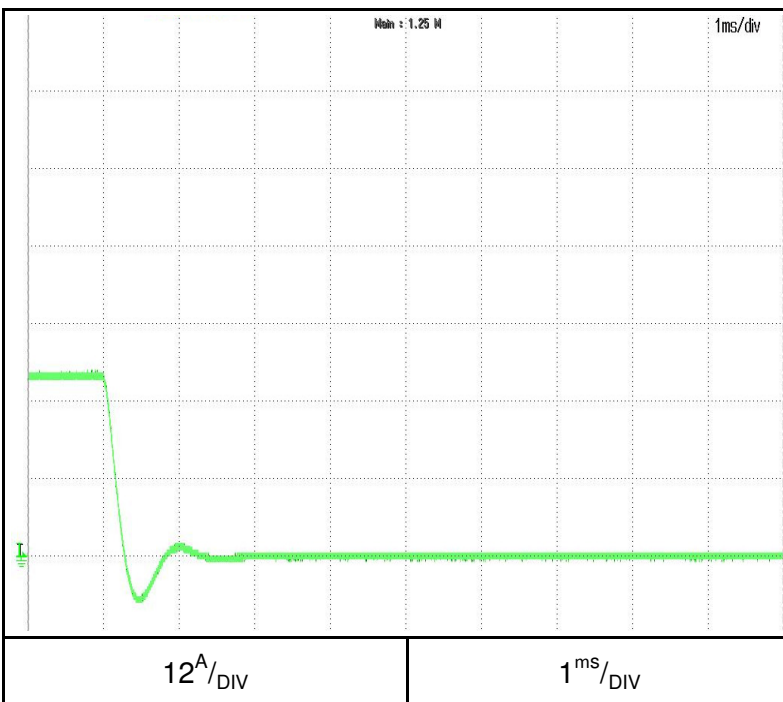

2.5 ON/OFF Output fall characteristics

C.C mode

Conditions: V_{in} : 100VAC
 I_{out} : 100%
shorted output
 $T_a = 25^\circ\text{C}$

G150-11.2

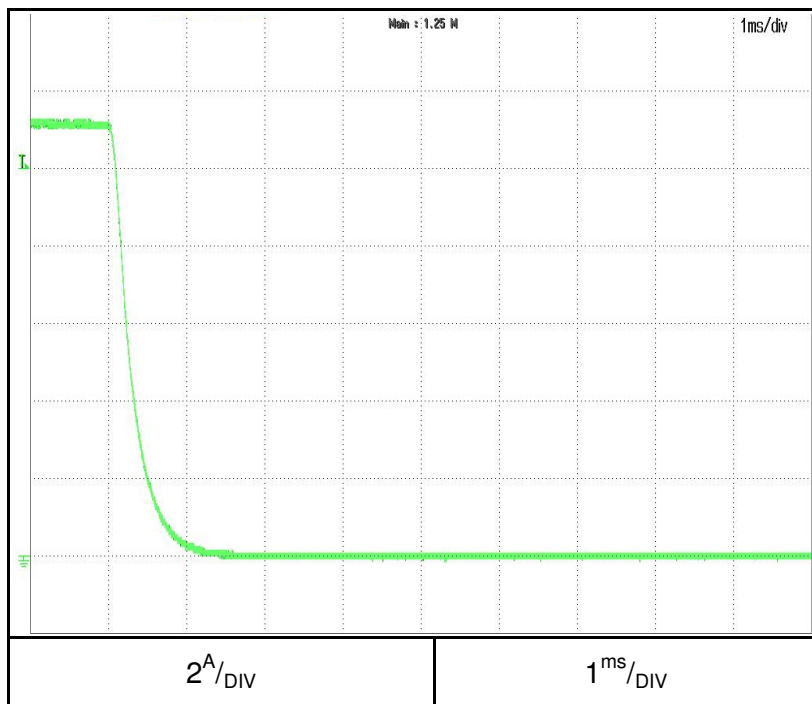

G600-2.8

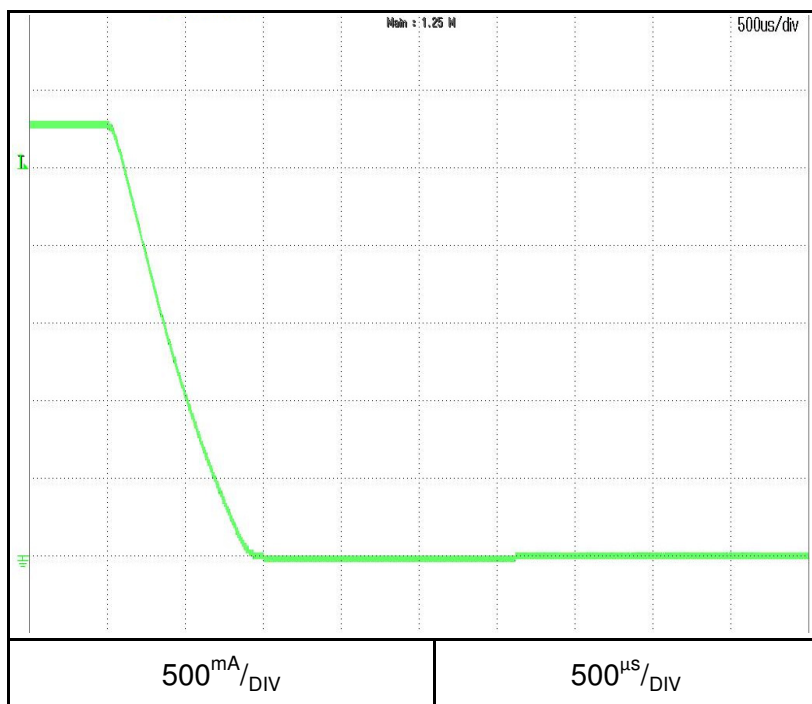

2.6 Holdup time characteristics

Conditions: Ta = 25°C

Vout:100%

G10-170

Vin:100VAC

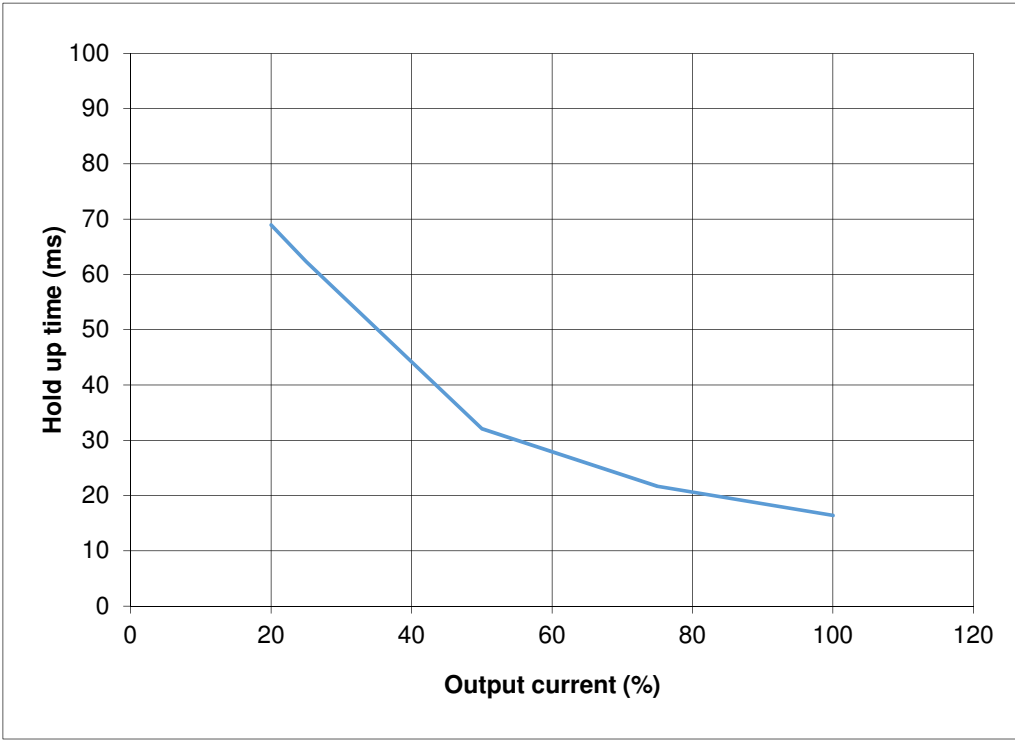

G10-170

Vin:200VAC

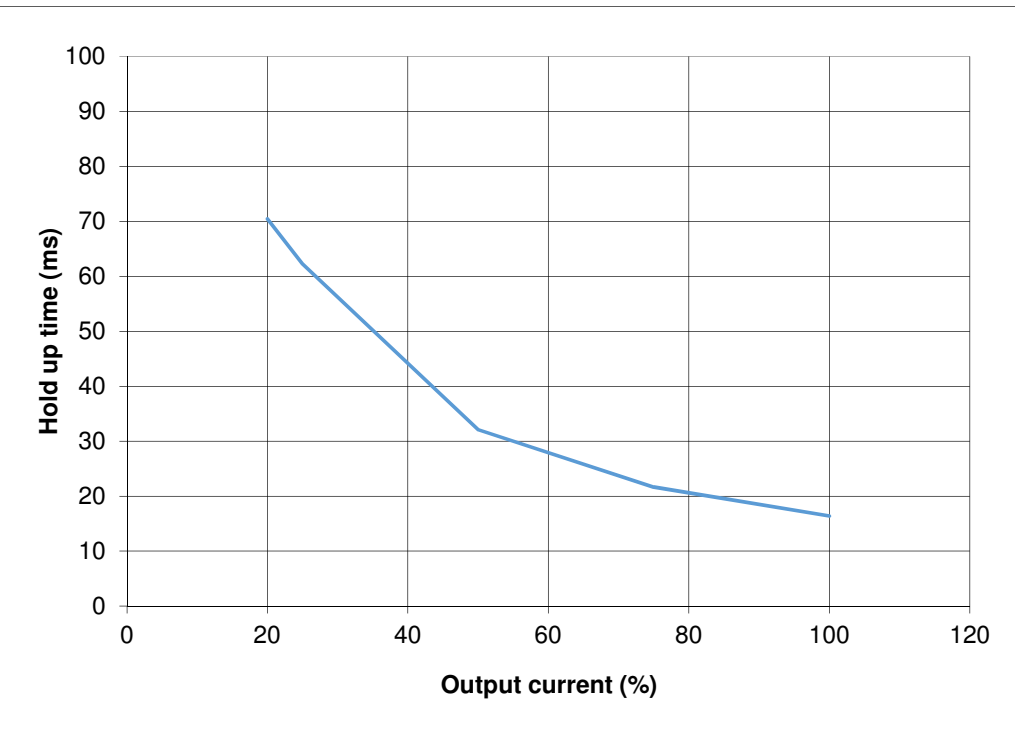

2.6 Holdup time characteristics

Conditions: $T_a = 25^\circ\text{C}$
 $V_{out}: 100\%$

G60-28

$V_{in}: 100\text{VAC}$

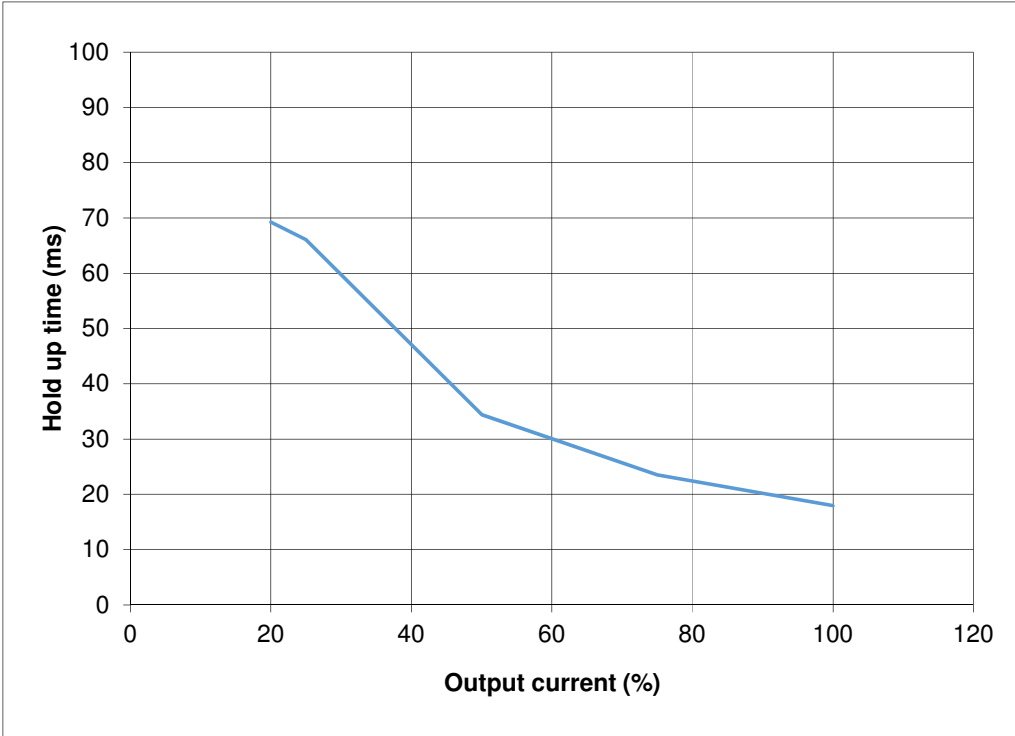

G60-28

$V_{in}: 200\text{VAC}$

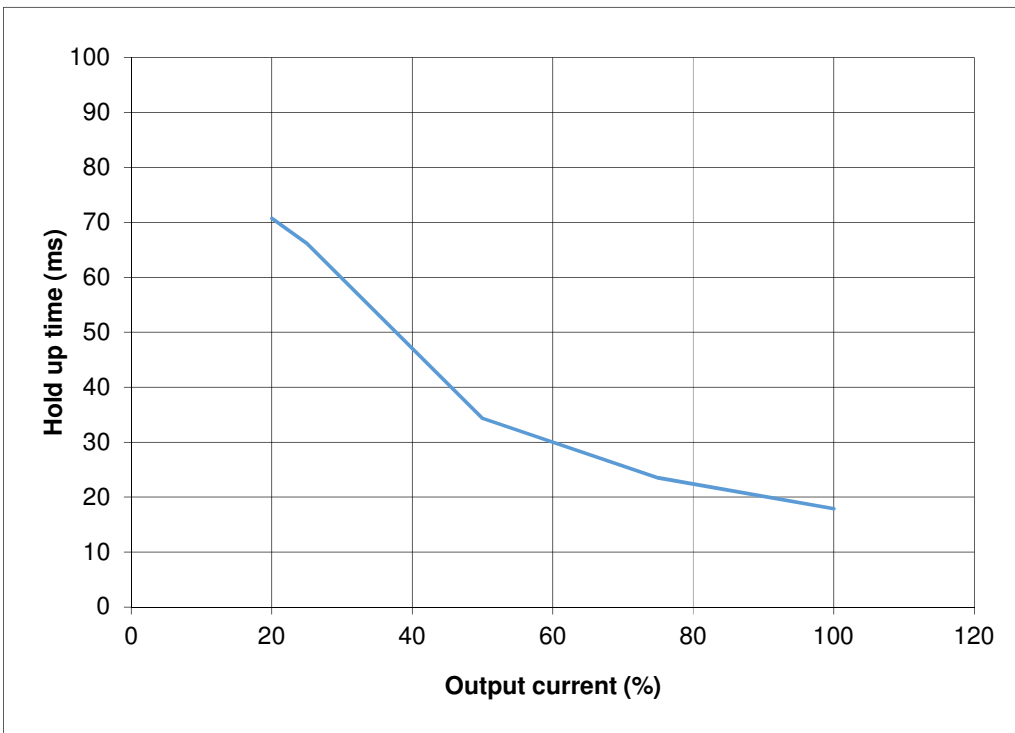

2.6 Holdup time characteristics

Conditions: Ta = 25°C

Vout:100%

G150-11.2

Vin:100VAC

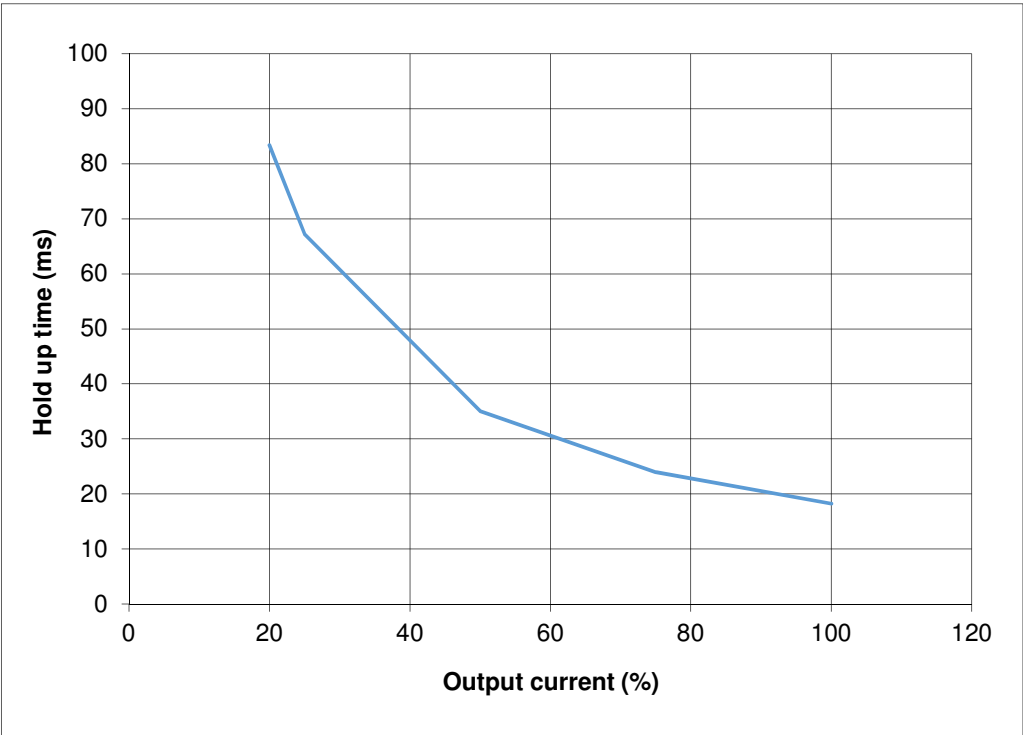

G150-11.2

Vin:200VAC

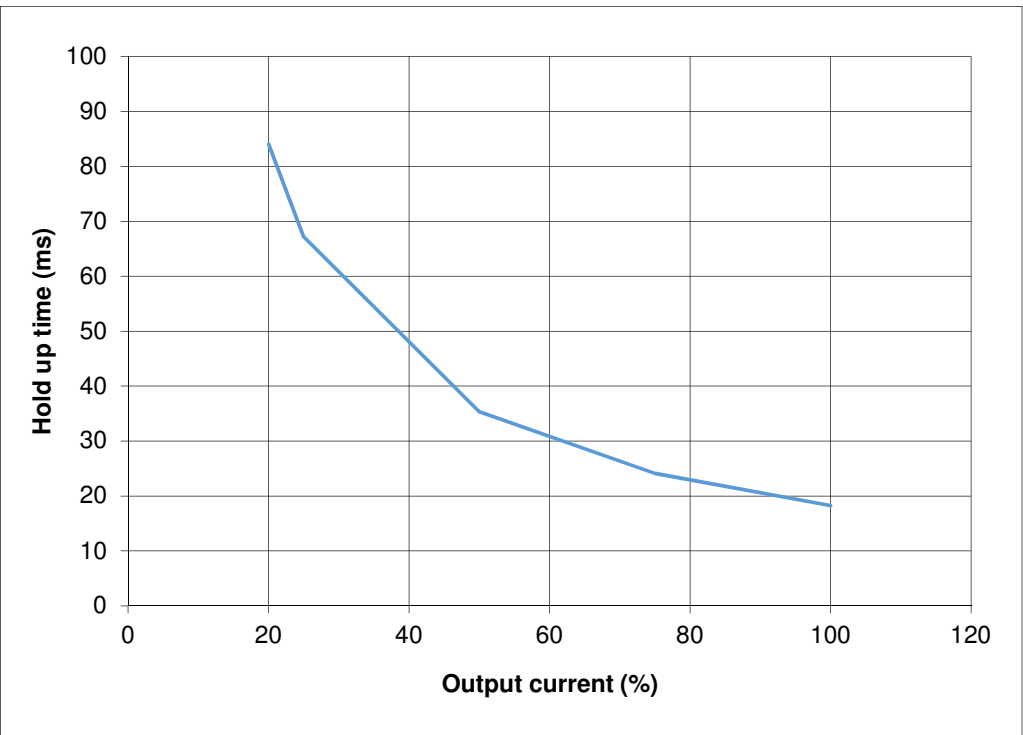

2.6 Holdup time characteristics

Conditions: $T_a = 25^\circ\text{C}$
 $V_{out}: 100\%$

G600-2.8

$V_{in}: 100\text{VAC}$

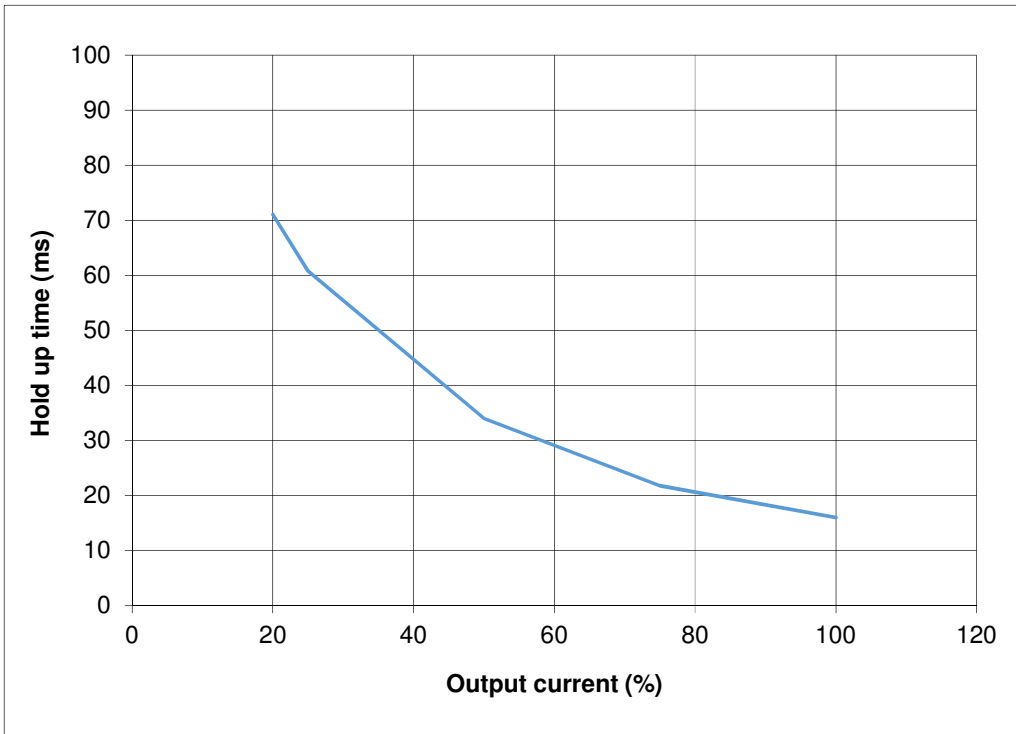

G600-2.8

$V_{in}: 200\text{VAC}$

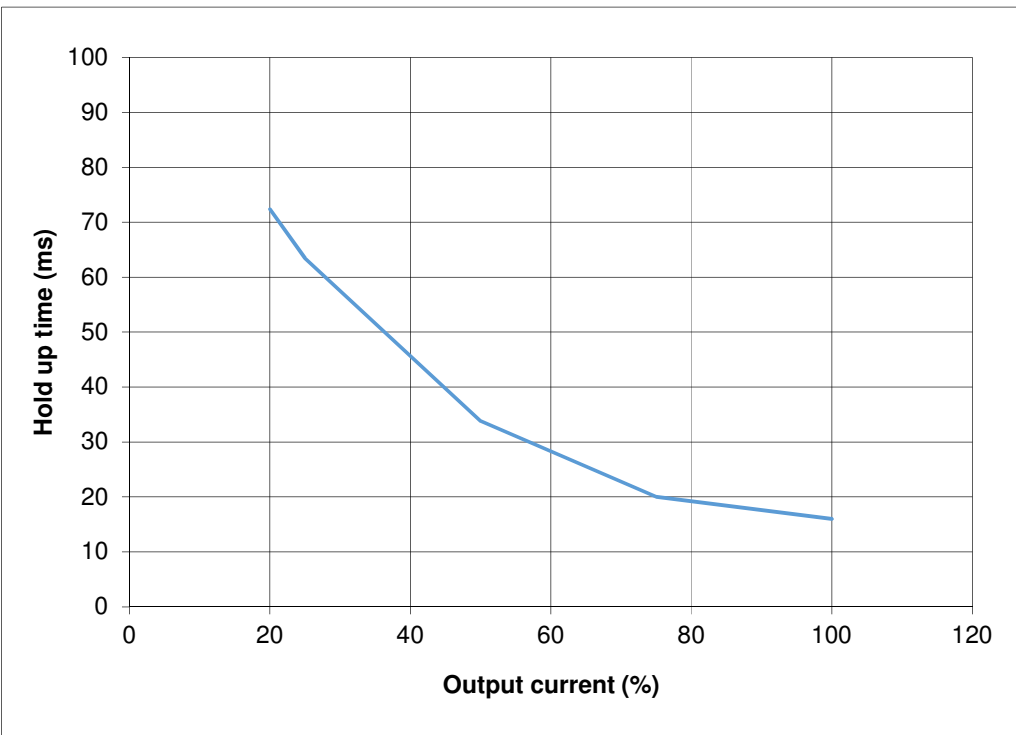

2.7 Dynamic line response characteristics

C.V mode

G10-170

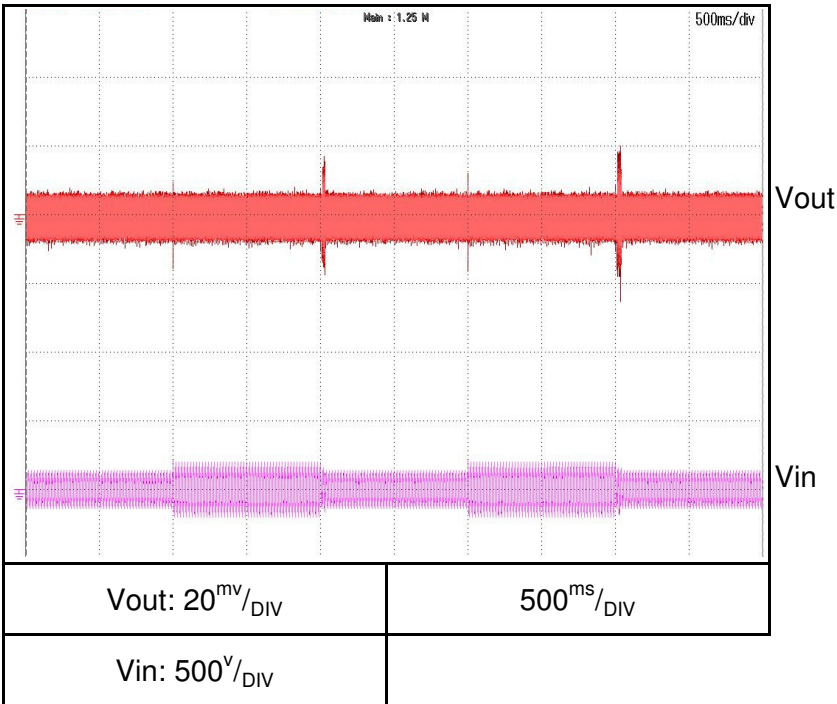
Conditions: Vout: 100%
Iout: 100%
Vin: 85↔132V

G10-170

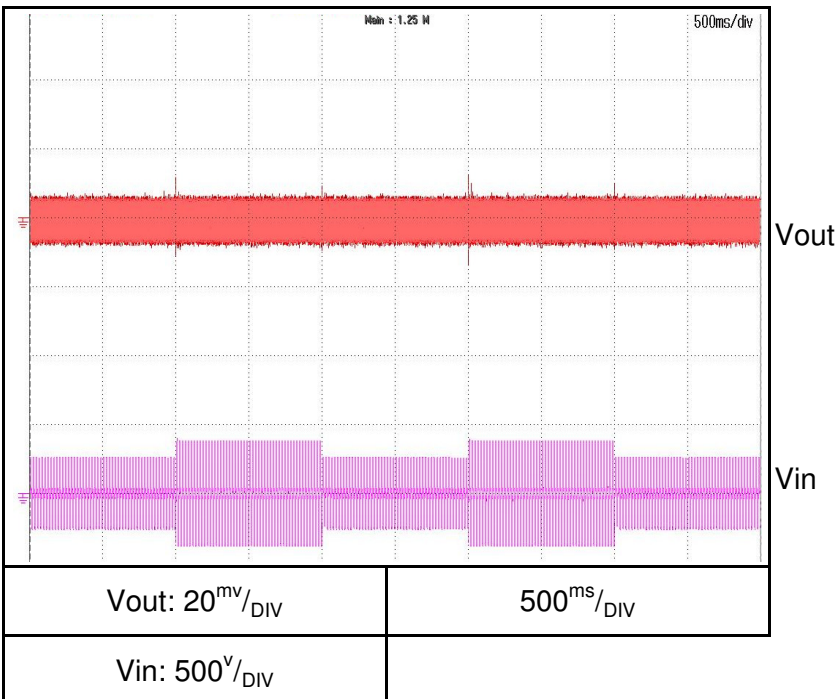
Conditions: Vout: 100%
Iout: 100%
Vin: 170↔265V

2.7 Dynamic line response characteristics

C.V mode

G60-28

Conditions: Vout: 100%
Iout: 100%
Vin: 85↔132V

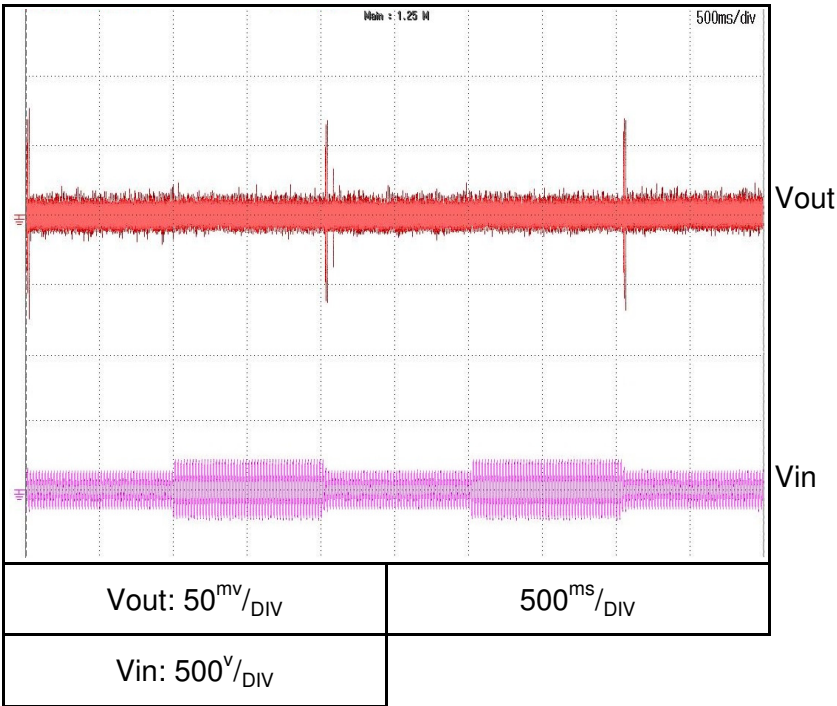

G60-28

Conditions: Vout: 100%
Iout: 100%
Vin: 170↔265V

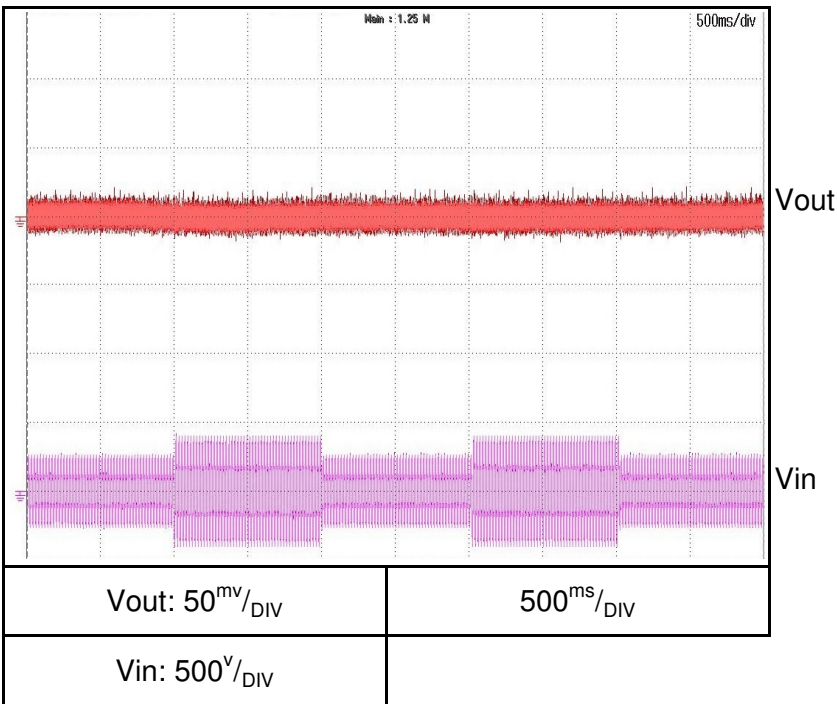

Ta = 25°C

2.7 Dynamic line response characteristics

C.V mode

G150-11.2

Conditions: Vout: 100%
Iout: 100%
Vin: 85↔132V

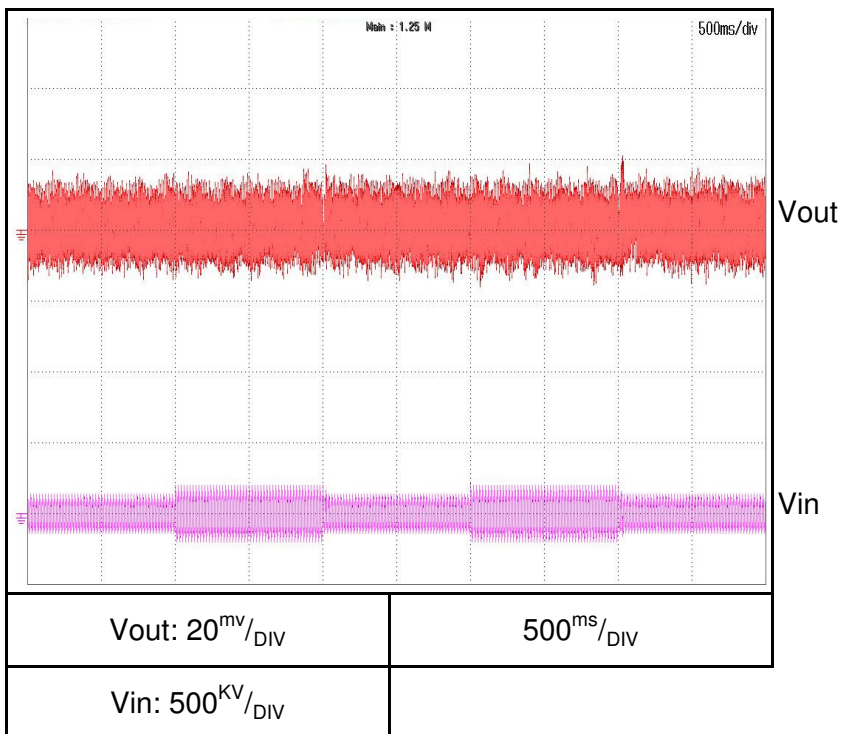

G150-11.2

Conditions: Vout: 100%
Iout: 100%
Vin: 170↔265V

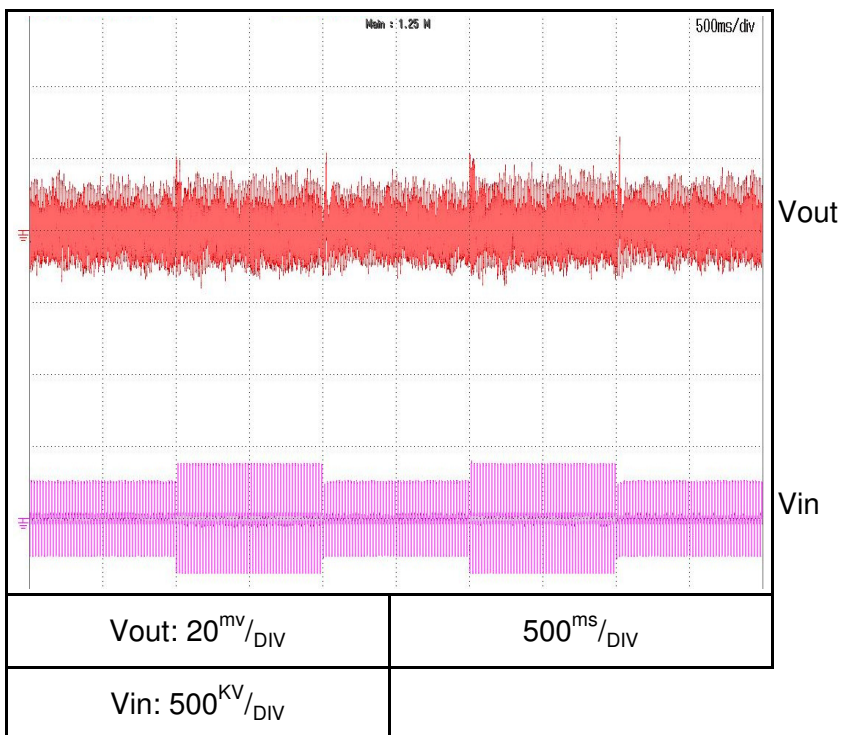

Ta = 25°C

2.7 Dynamic line response characteristics

C.V mode

G600-2.8

Conditions: Vout: 100%
Iout: 100%
Vin: 85↔132V

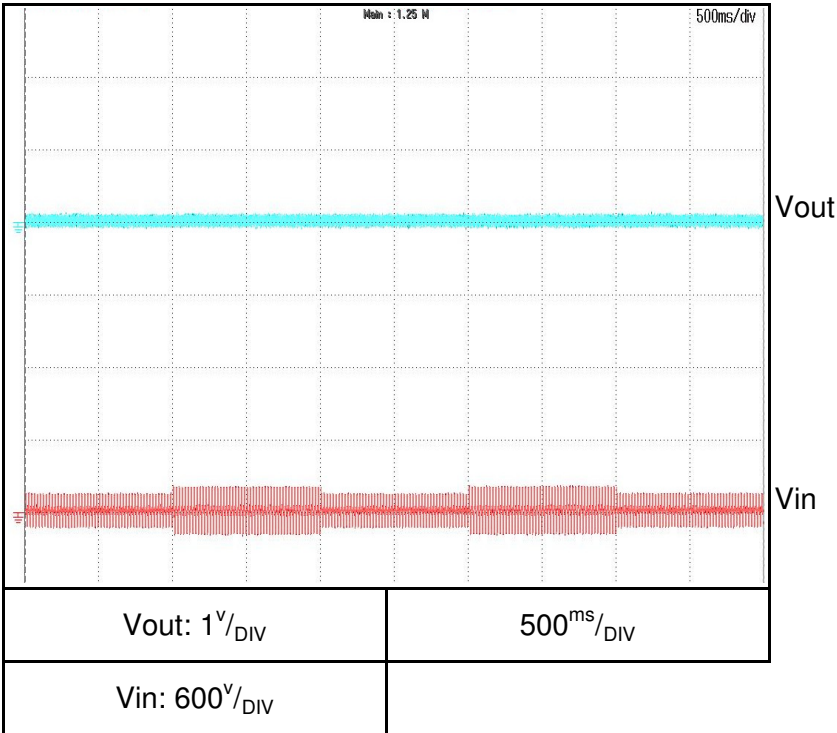

G600-2.8

Conditions: Vout: 100%
Iout: 100%
Vin: 170↔265V

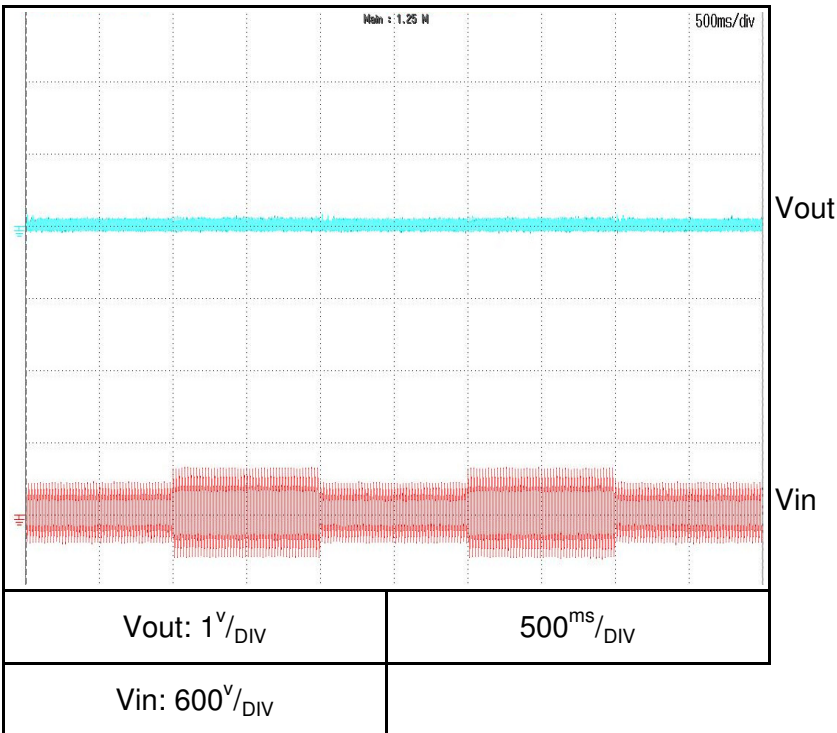

2.7 Dynamic line response characteristics
C.C mode

G10-170

Conditions: Vout: 100%
Iout: 100%
Vin: 85↔132V

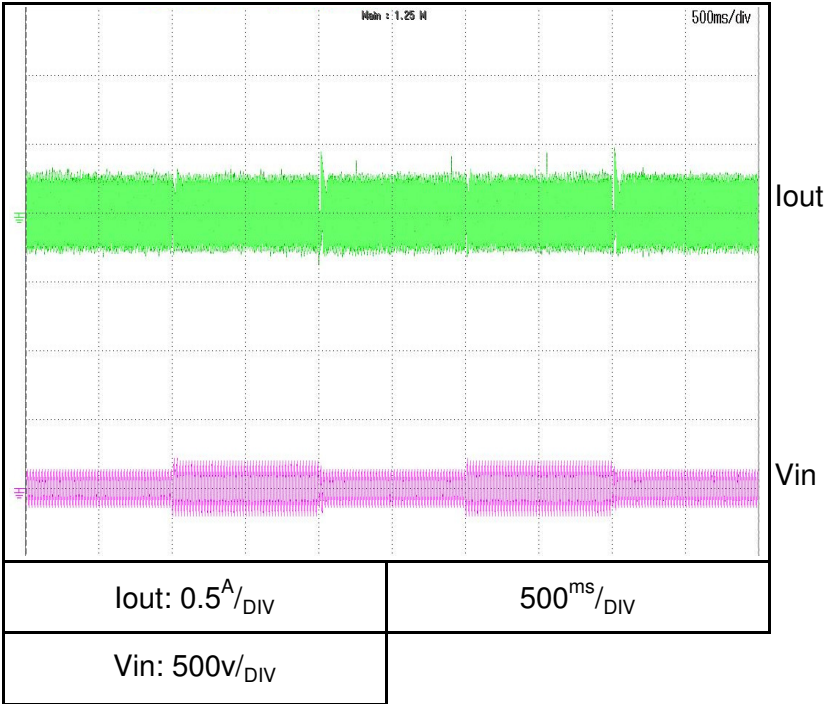

G10-170

Conditions: Vout: 100%
Iout: 100%
Vin: 170↔265V

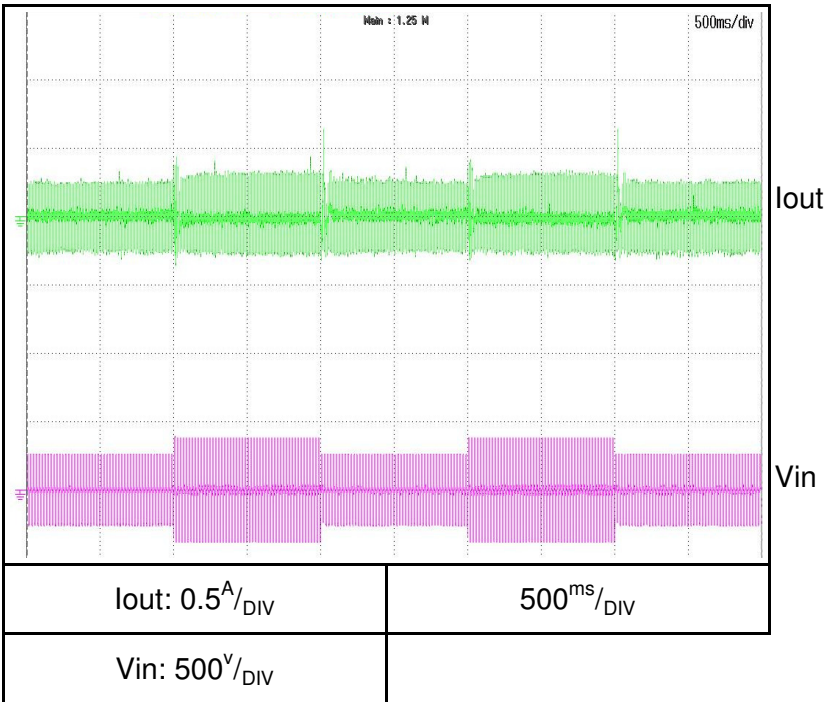

2.7 Dynamic line response characteristics

C.C mode

G60-28

Conditions: Vout: 100%
Iout: 100%
Vin: 85↔132V

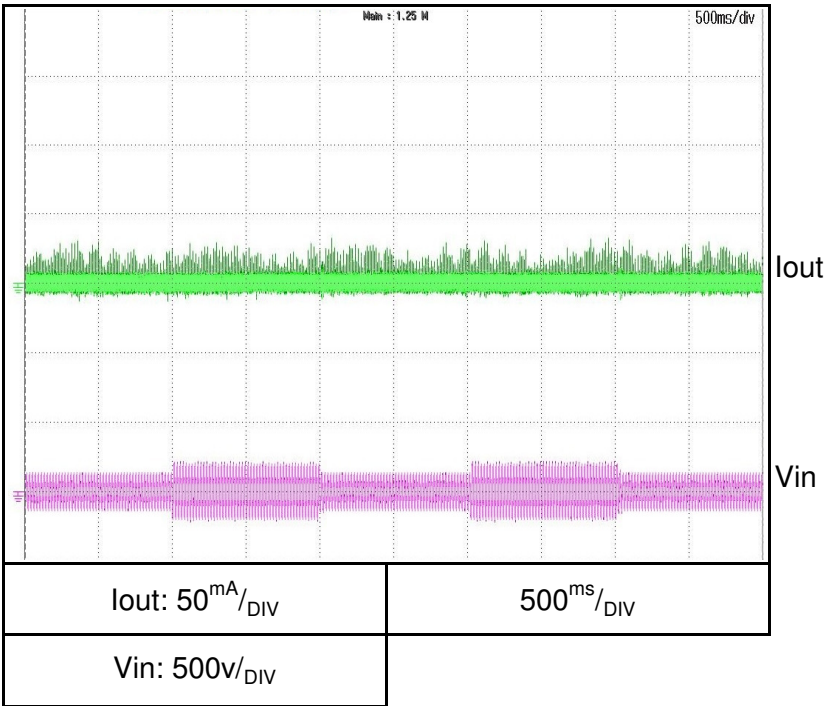

G60-28

Conditions: Vout: 100%
Iout: 100%
Vin: 170↔265V

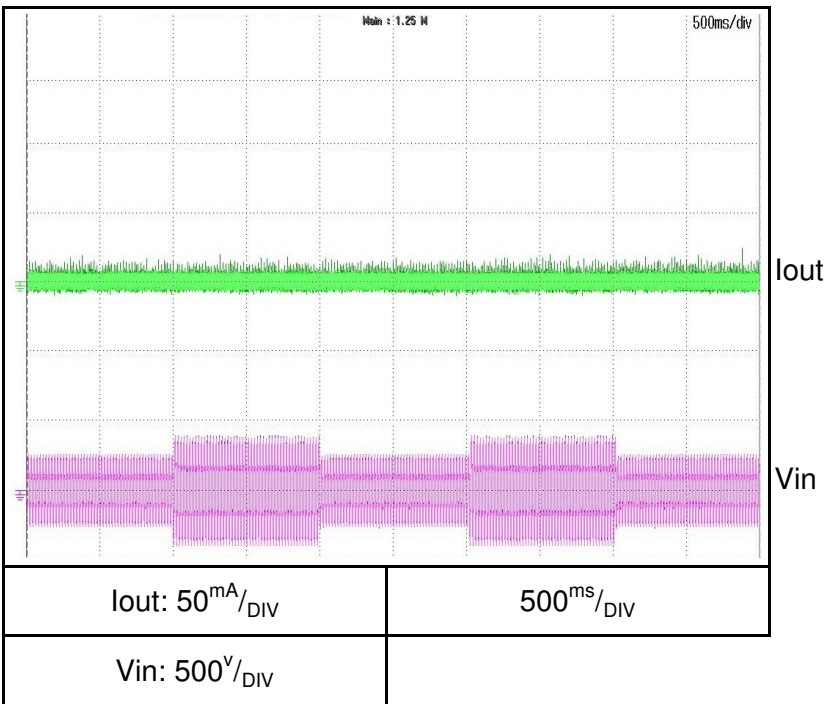

2.7 Dynamic line response characteristics

C.C mode

G150-11.2

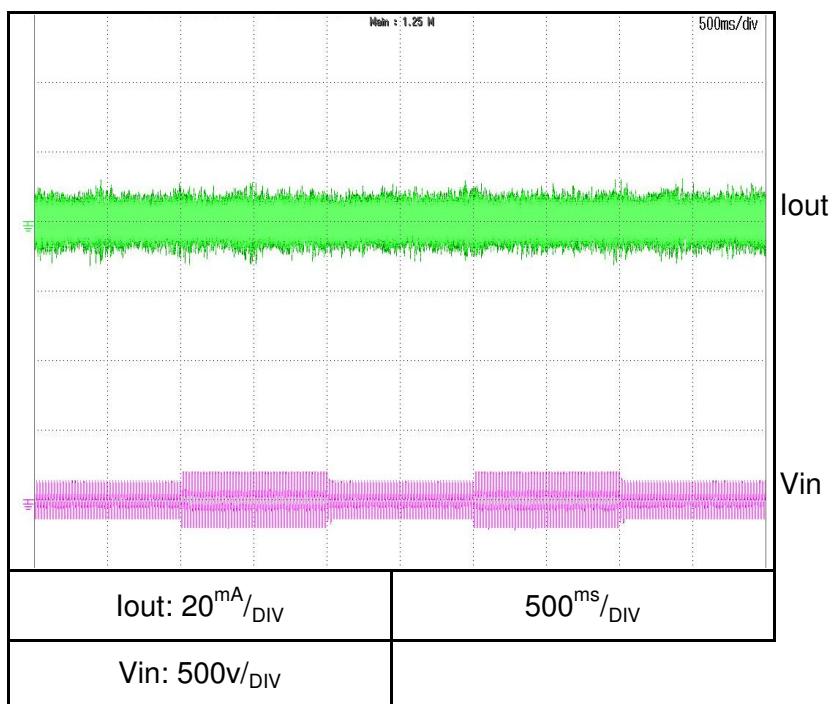
Conditions: Vout: 100%
Iout: 100%
Vin: 85↔132V

G150-11.2

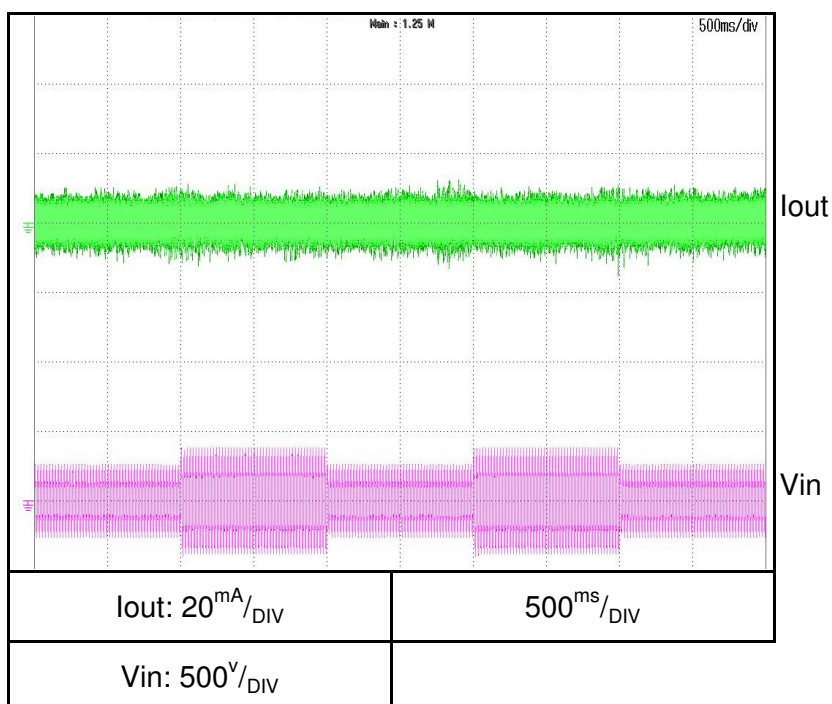
Conditions: Vout: 100%
Iout: 100%
Vin: 170↔265V

2.7 Dynamic line response characteristics

C.C mode

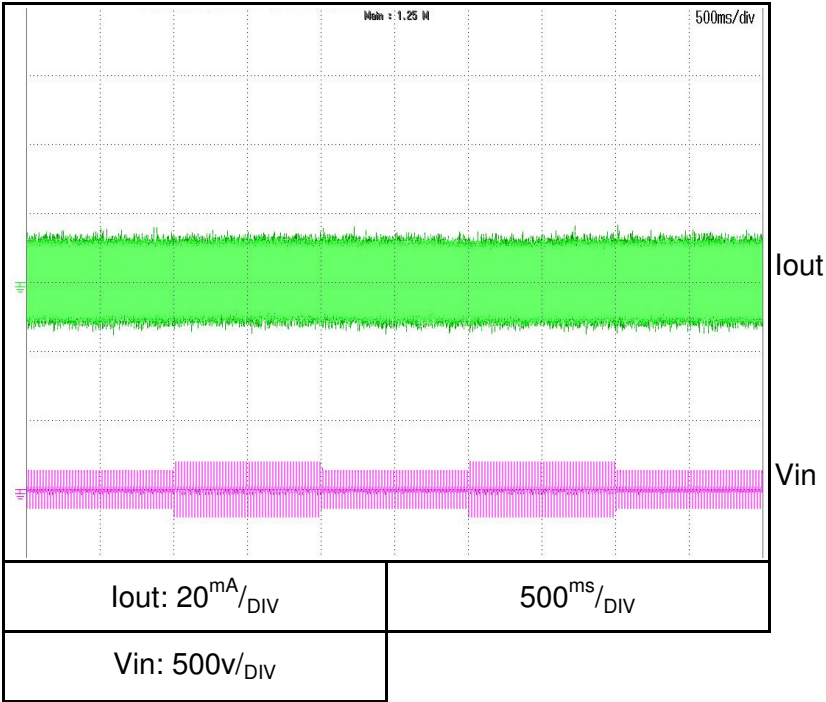
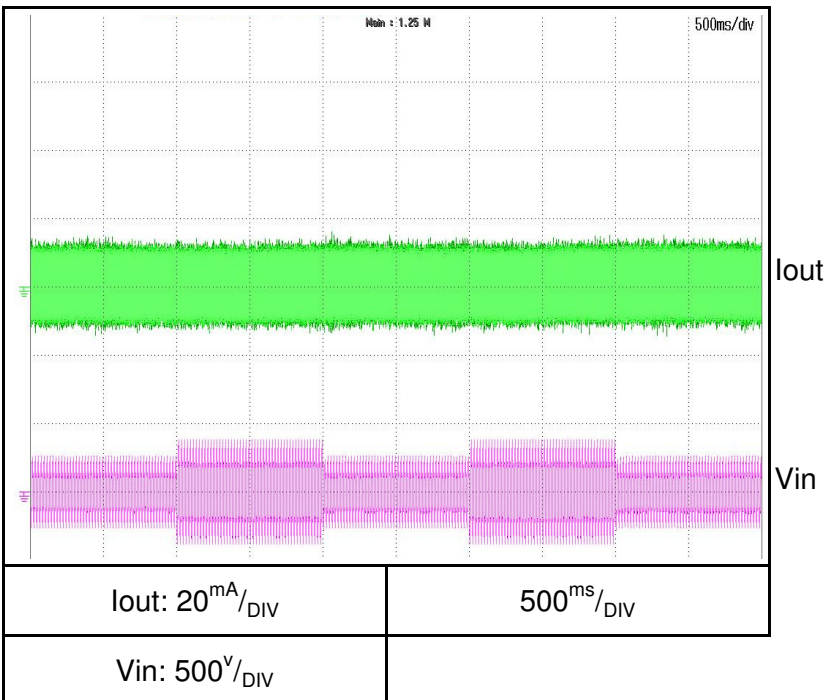
G600-2.8Conditions: Vout: 100%
Iout: 100%
Vin: 85↔132V**G600-2.8**Conditions: Vout: 100%
Iout: 100%
Vin: 170↔265V

2.8 Dynamic load response characteristics
C.V mode

Conditions: Vin: Nominal
Vout: 100%
Ta = 25°C

Load current: tr=tf=100us

G10-170

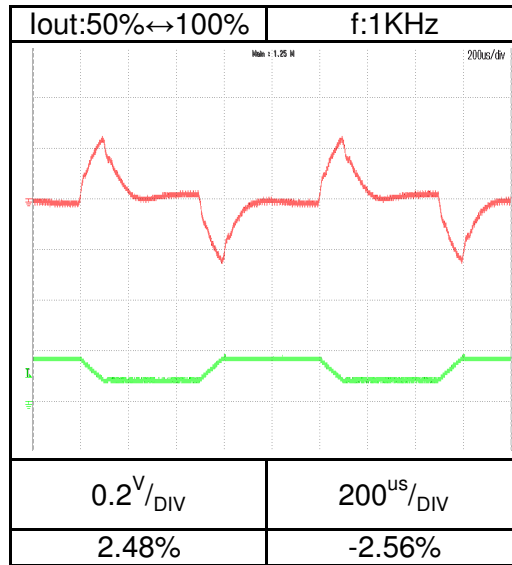
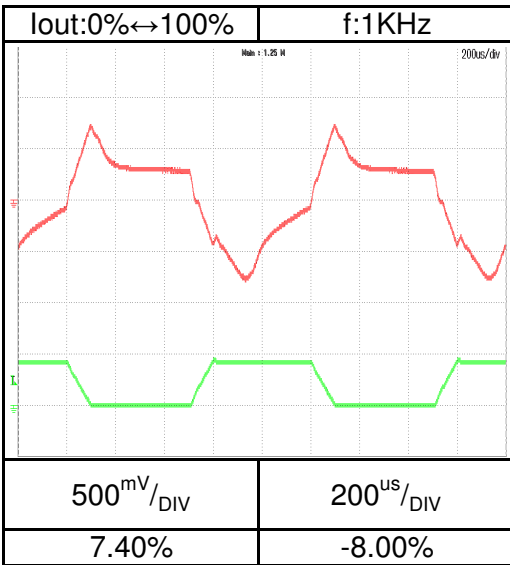
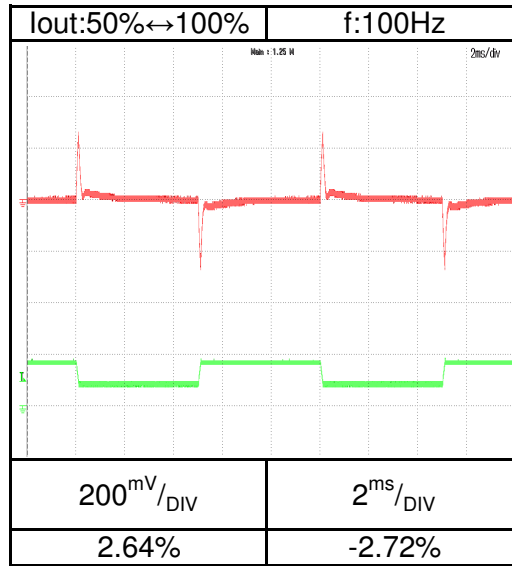
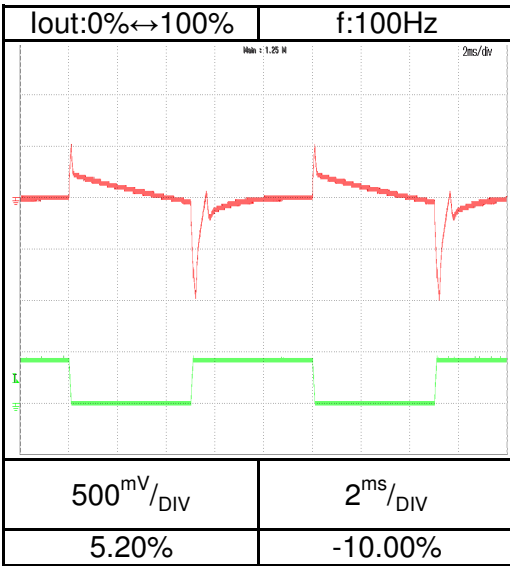

2.8 Dynamic load response characteristics
C.V mode

Conditions: Vin: Nominal
Vout: 100%
Ta = 25°C

Load current: tr=tf=100us

G60-28

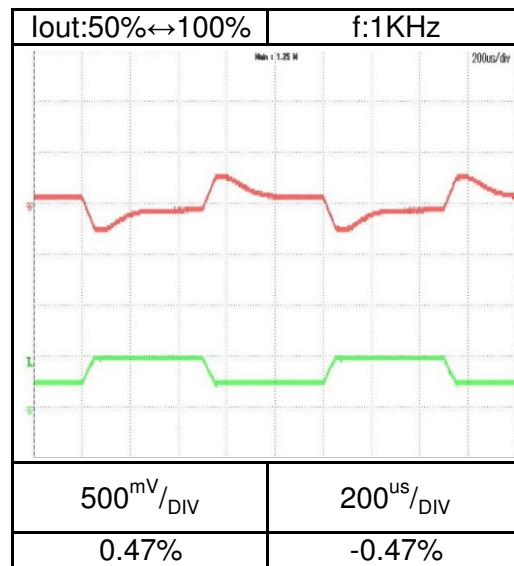
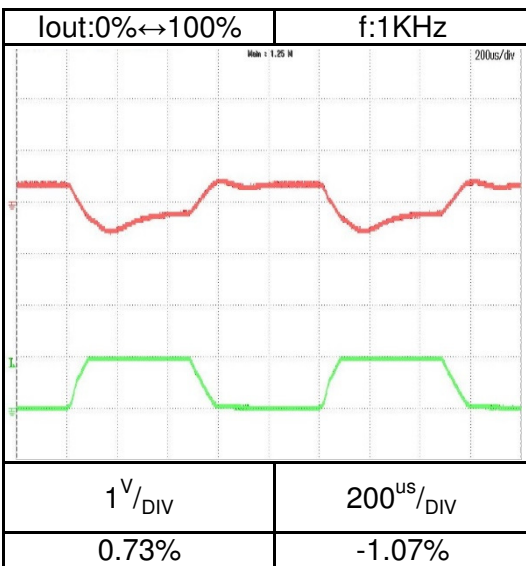
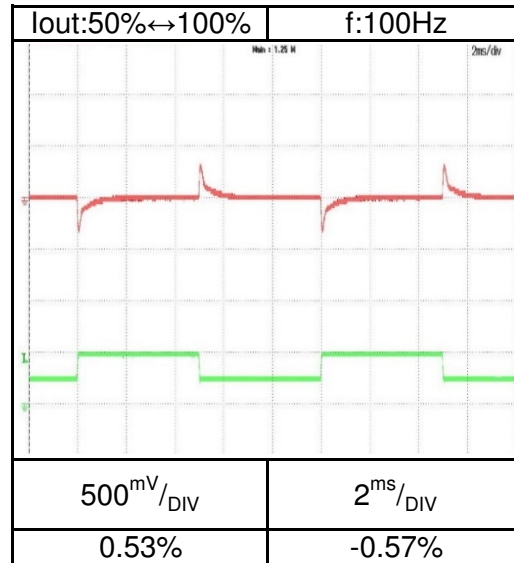
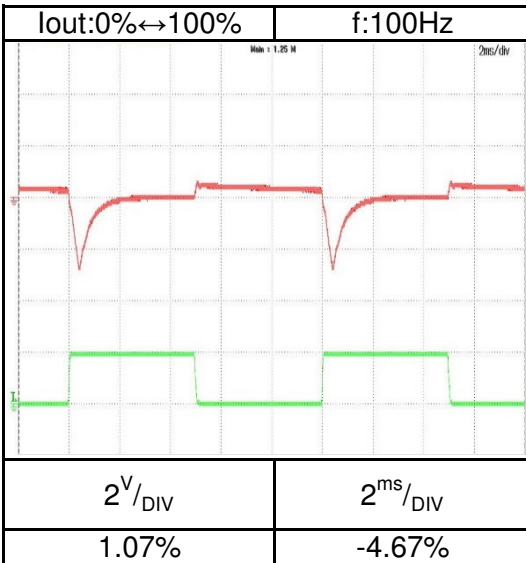

2.8 Dynamic load response characteristics
C.V mode

Conditions: Vin: Nominal
Vout: 100%
Ta = 25°C

Load current: tr=tf=100us

G150-11.2

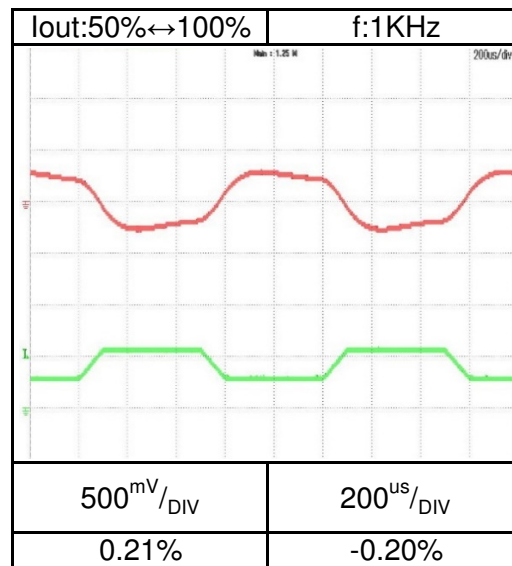
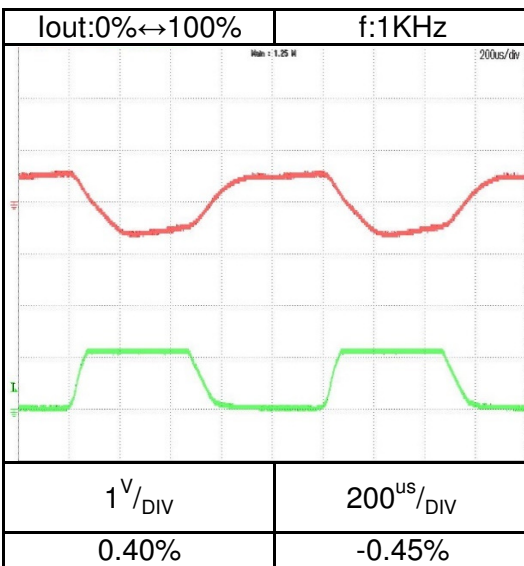
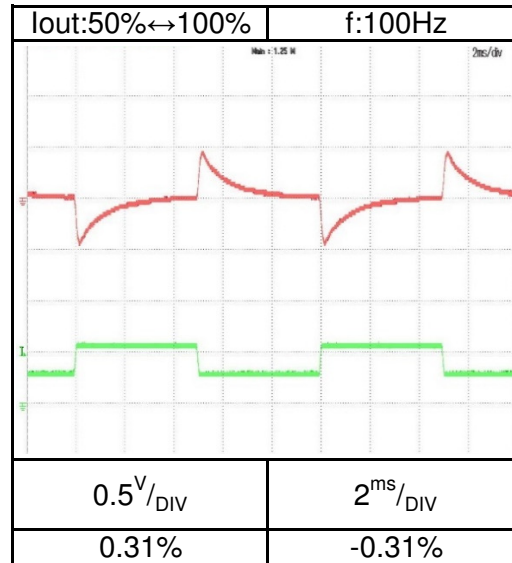
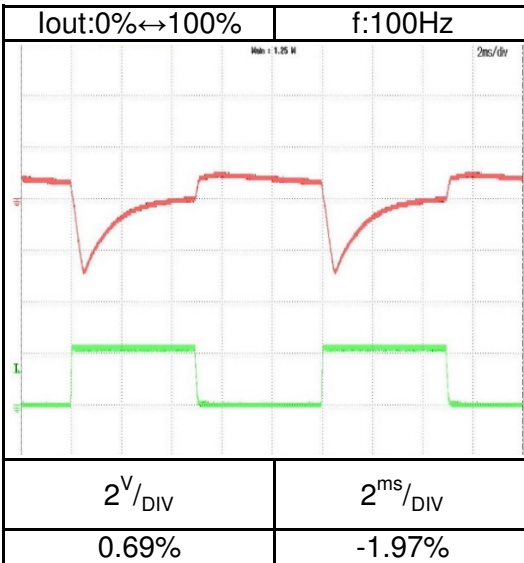

2.8 Dynamic load response characteristics
C.V mode

Conditions: Vin: Nominal
Vout: 100%
Ta = 25°C

Load current: tr=tf=100us

G600-2.8

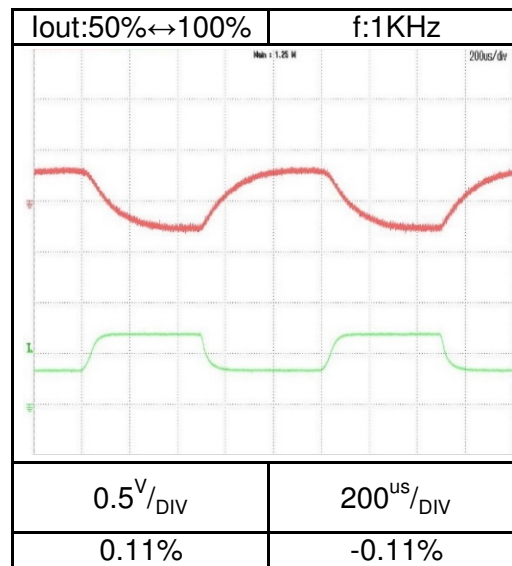
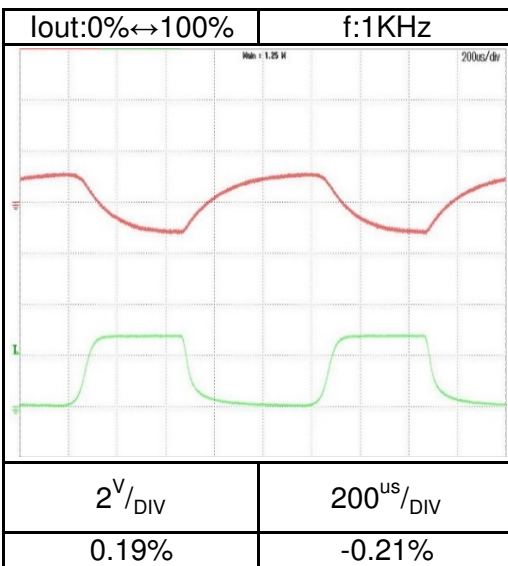
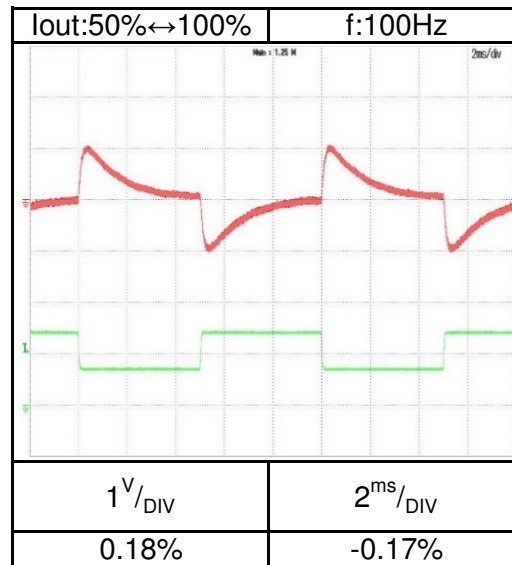
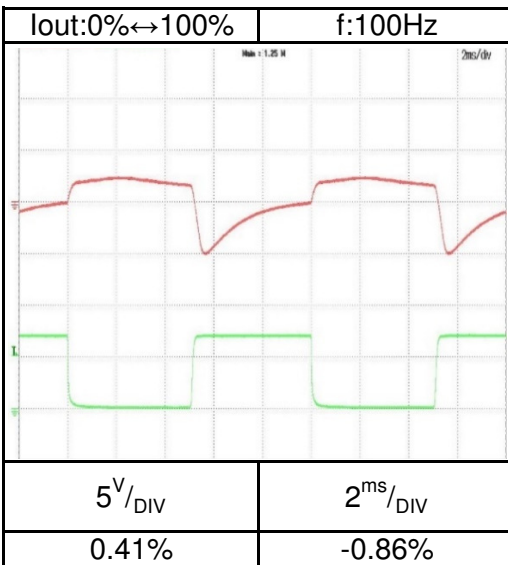

2.8 Dynamic load response characteristics
C.C mode

Conditions: Vin: Nominal
Ta = 25°C

G10-170

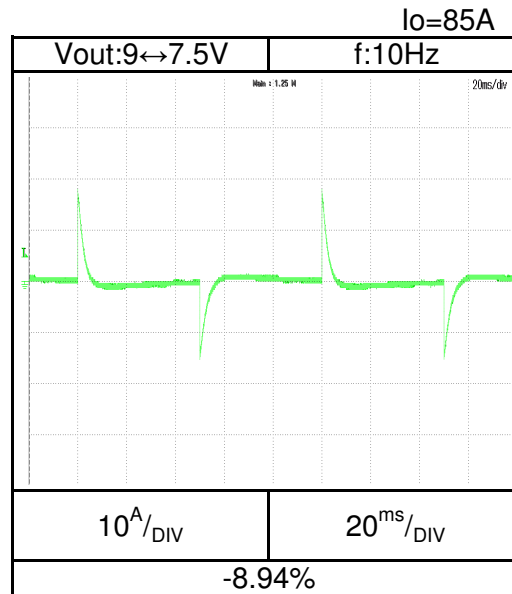
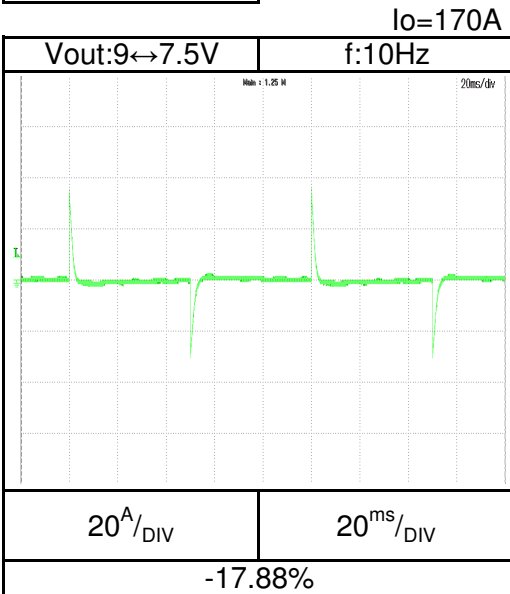

G60-28

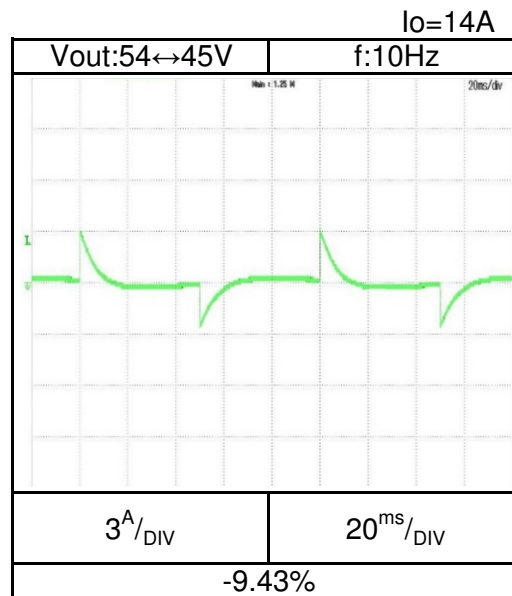
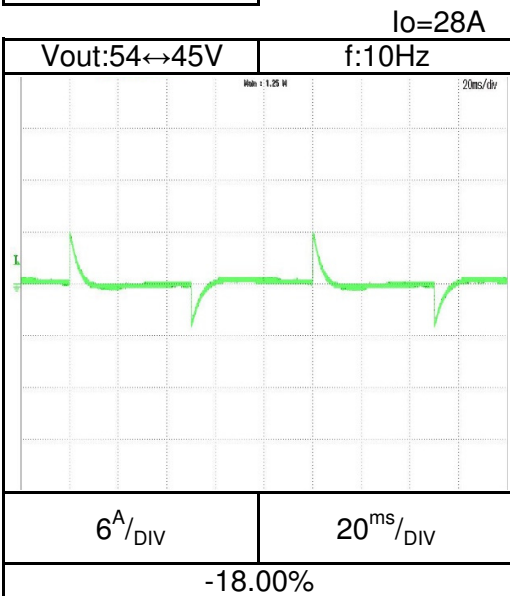

2.8 Dynamic load response characteristics
C.C mode

Conditions: Vin: Nominal
Ta = 25°C

G150-11.2

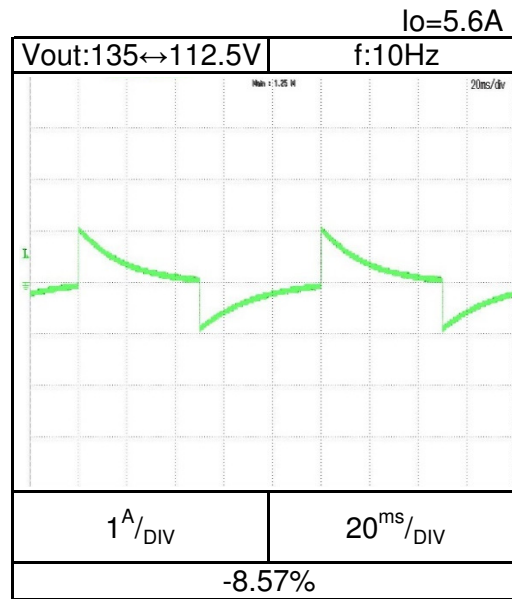
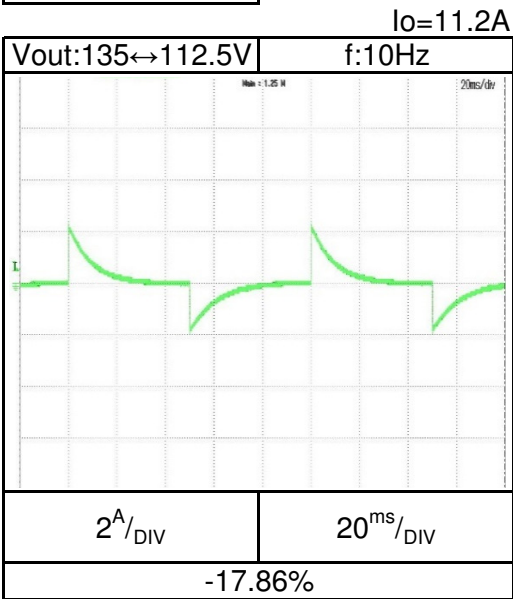

G600-2.8

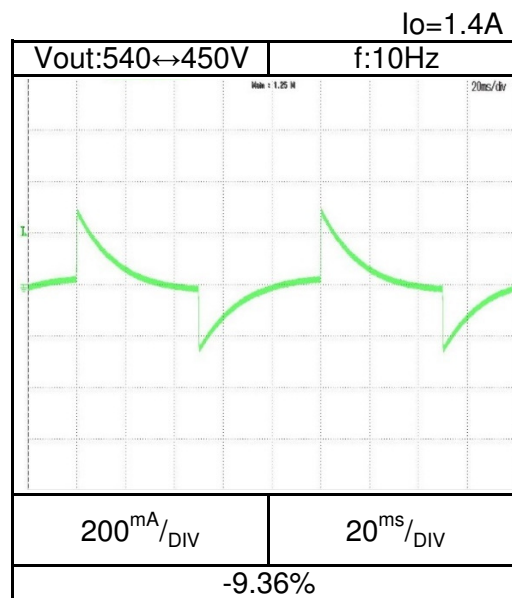
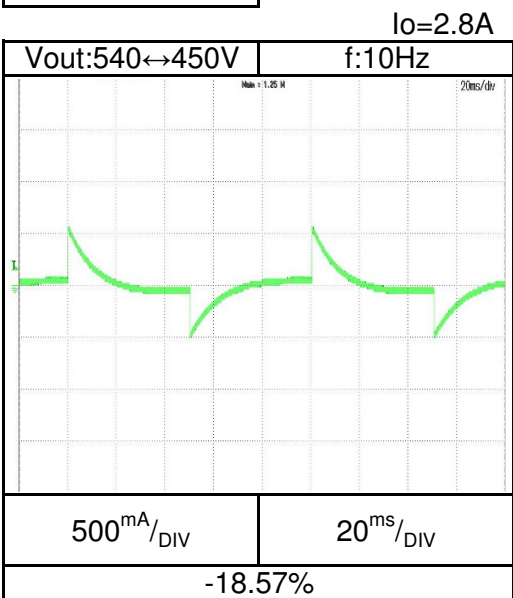

2.9 Response to brown-out characteristics
C.V mode

Conditions: Vout: 100%
Iout: 100%
Ta = 25°C

G10-170

Vin:100VAC

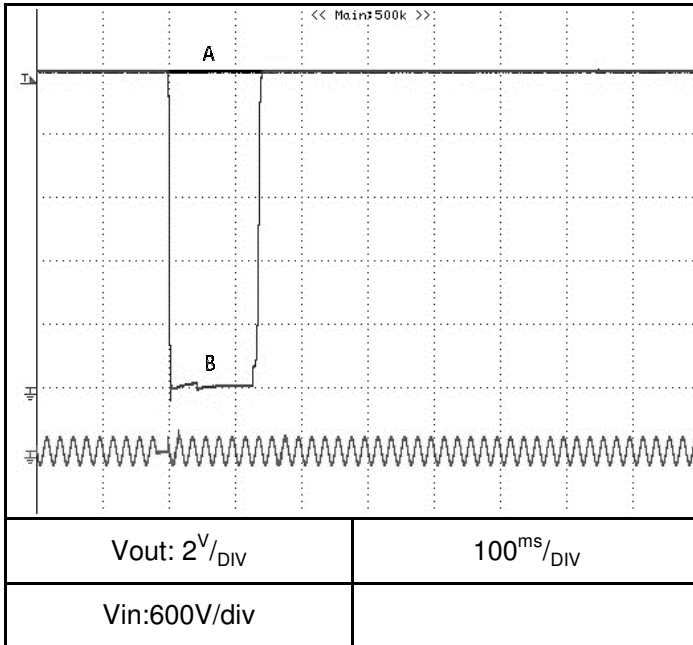

Brown-out time
A: 16mS
B: 17mS

G10-170

Vin:200VAC

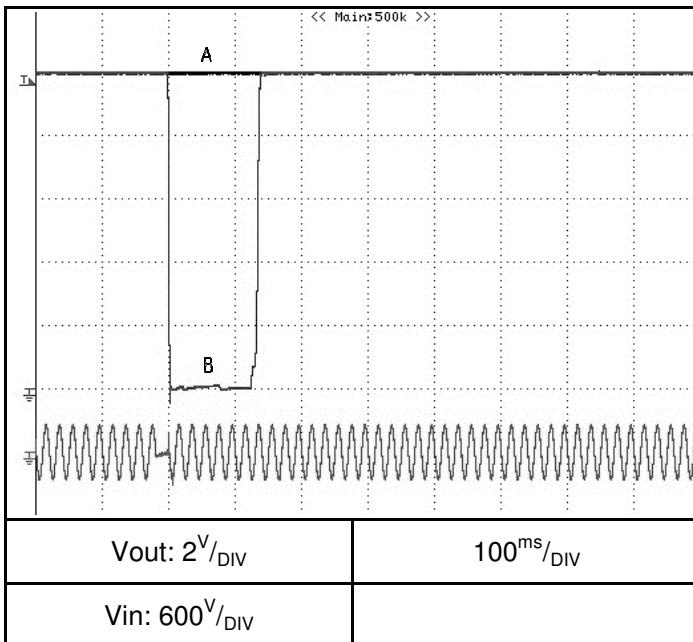

Brown-out time
A: 17mS
B: 18mS

2.9 Response to brown-out characteristics
C.V mode

Conditions: Vout: 100%
Iout: 100%
Ta = 25 °C

G60-28

Vin:100VAC

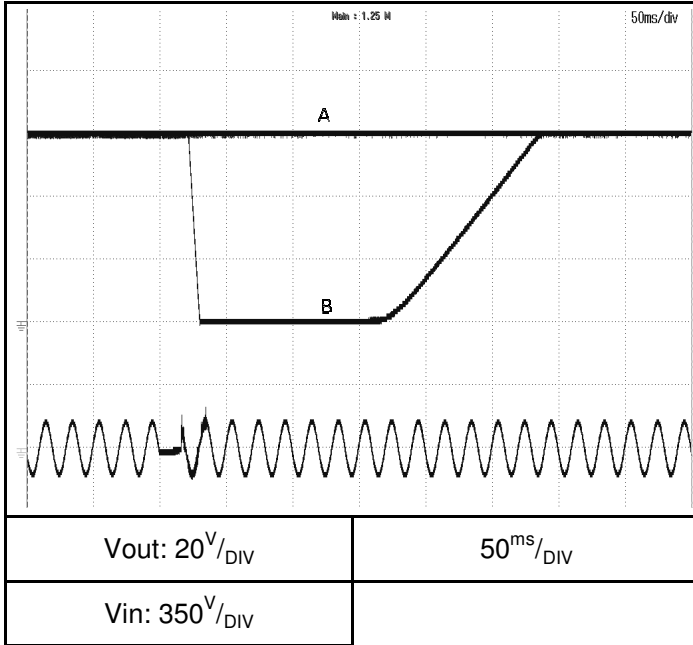

Brown-out time
A: 16.0mS
B: 16.5mS

G60-28

Vin:200VAC

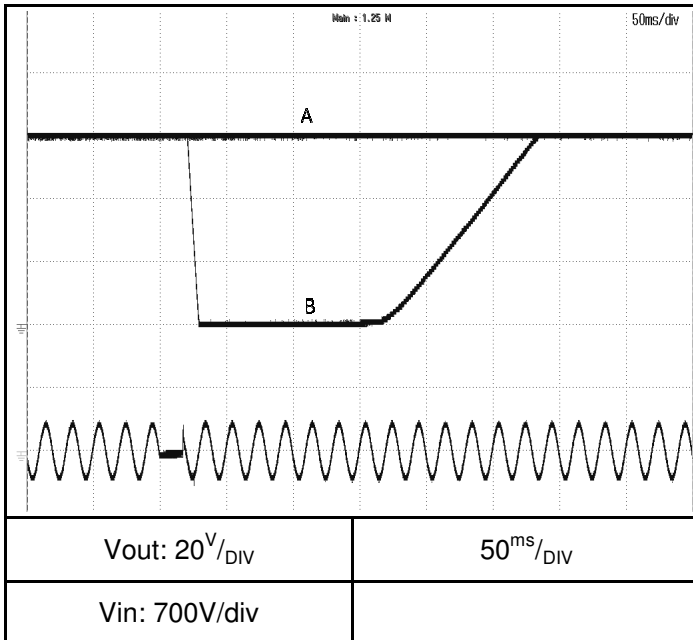

Brown-out time
A: 17.0mS
B: 17.5mS

2.9 Response to brown-out characteristics
C.V mode

Conditions: Vout: 100%
Iout: 100%
Ta = 25 °C

G150-11.2

Vin:100VAC

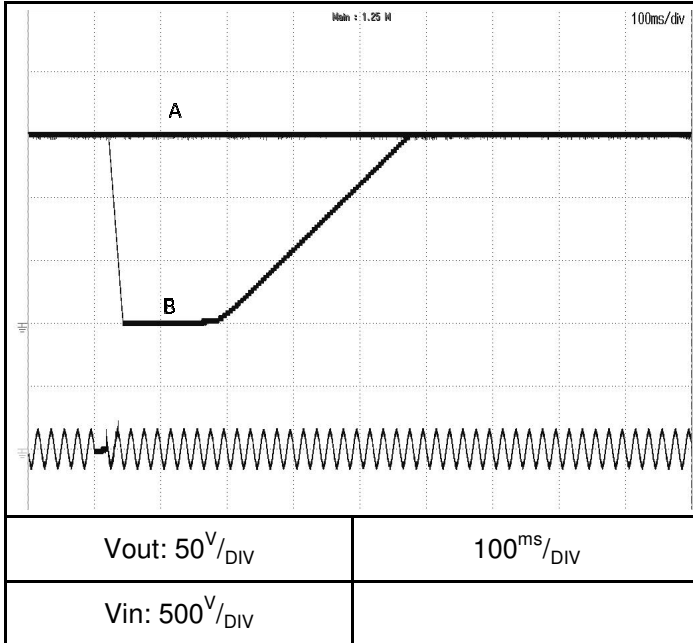

Brown-out time

A: 16mS
B: 17mS

G150-11.2

Vin:200VAC

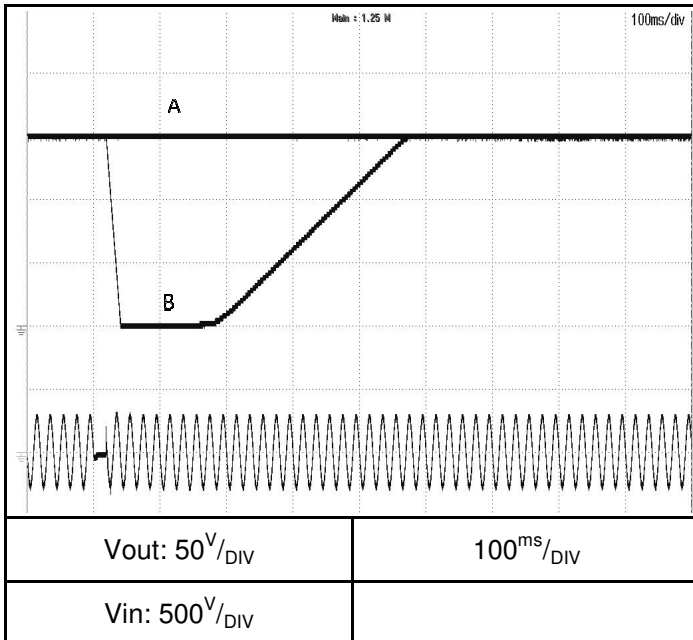

Brown-out time

A: 17mS
B: 18mS

2.9 Response to brown-out characteristics
C.V mode

Conditions: Vout: 100%
Iout: 100%
Ta = 25°C

G600-2.8

Vin:100VAC

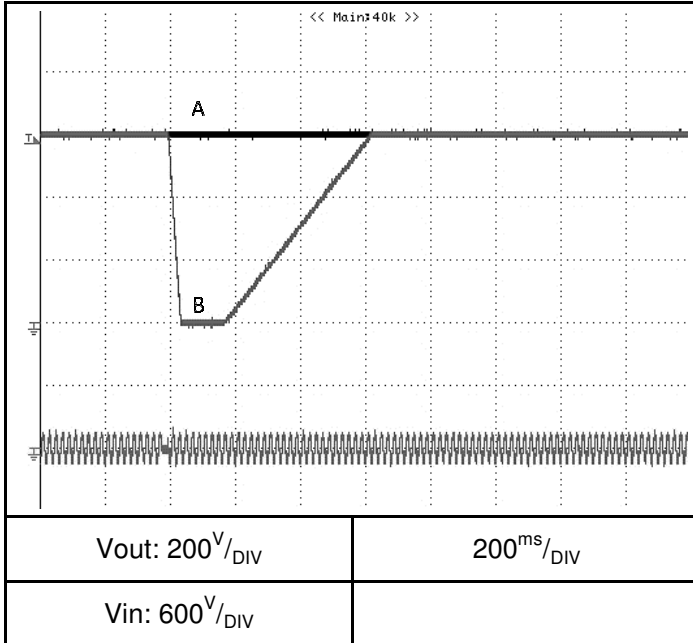

Brown-out time
A:17mS
B:18mS

G600-2.8

Vin:200VAC

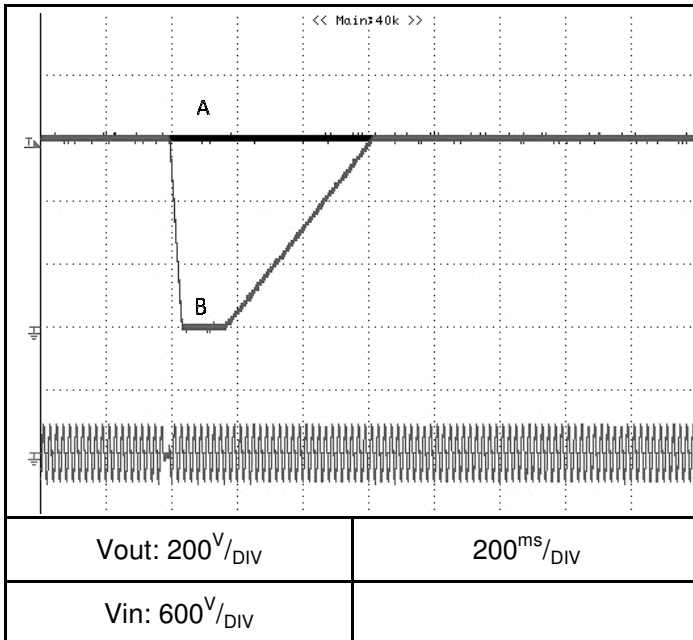

Brown-out time
A:18mS
B:19mS

2.9 Response to brown-out characteristics
C.C mode

Conditions:

Vout: 100%
Iout: 100%
Ta = 25°C

G10-170

Vin:100VAC

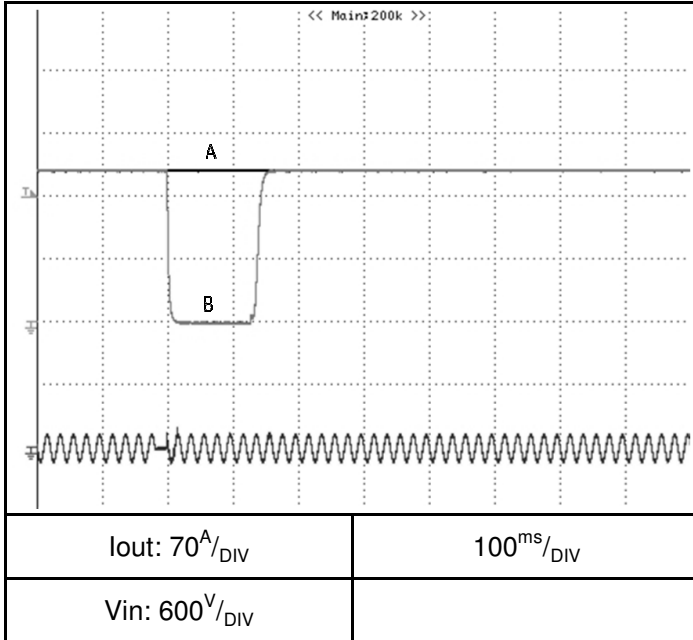

Brown-out time
A: 16mS
B: 17mS

G10-170

Vin:200VAC

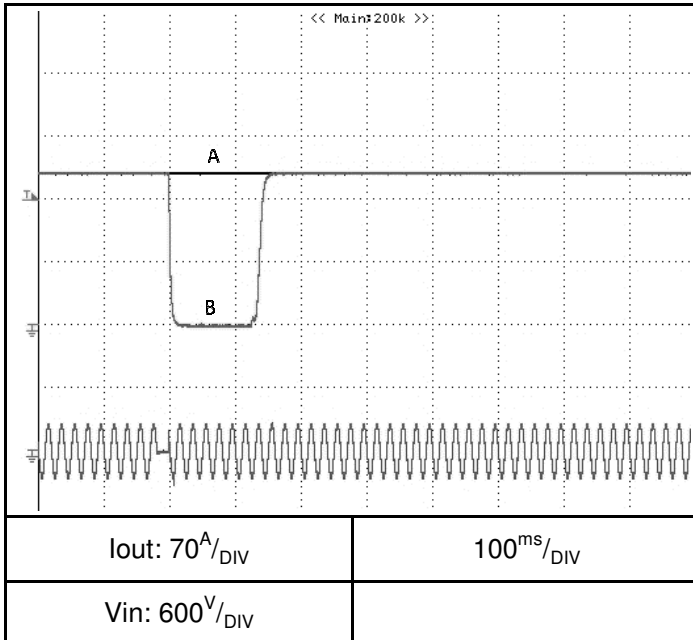

Brown-out time
A: 17mS
B: 18mS

2.9 Response to brown-out characteristics
C.C mode

Conditions:

Vout: 100%
Iout: 100%
Ta = 25°C

G60-28

Vin:100VAC

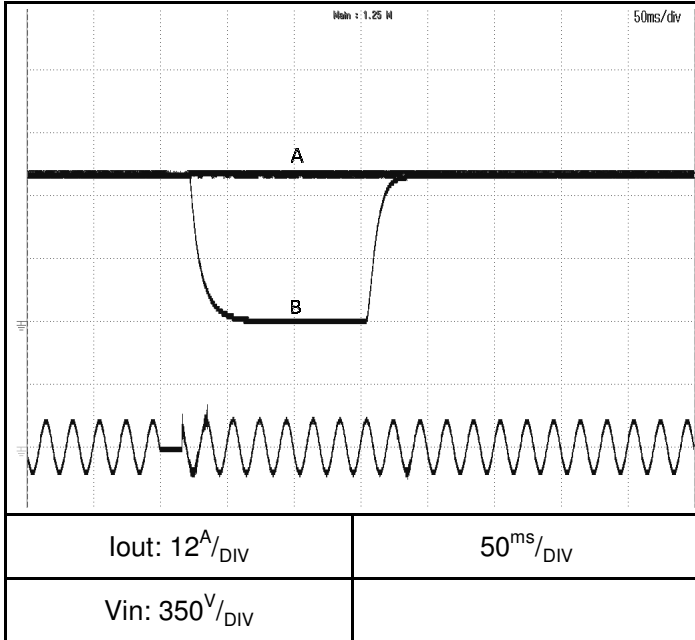

Brown-out time
A: 16.0mS
B: 16.5mS

G60-28

Vin:200VAC

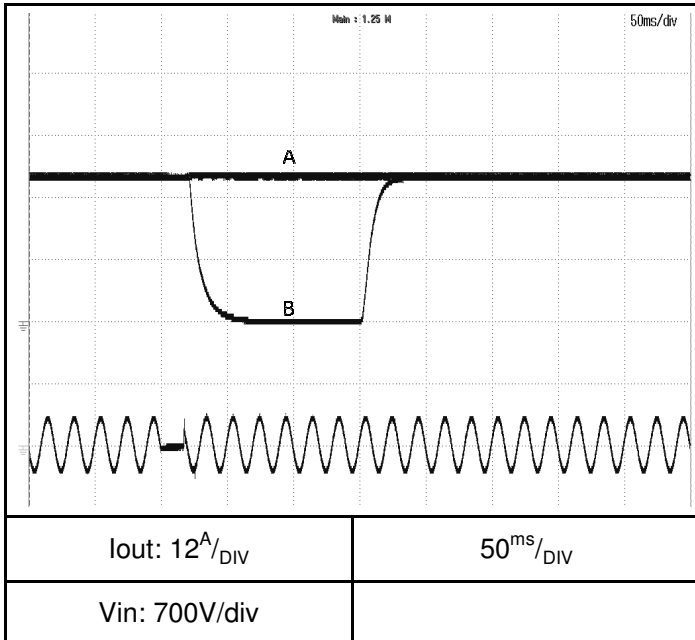

Brown-out time
A: 17.0mS
B: 17.5mS

2.9 Response to brown-out characteristics
C.C mode

Conditions:

Vout: 100%
Iout: 100%
Ta = 25°C

G150-11.2

Vin:100VAC

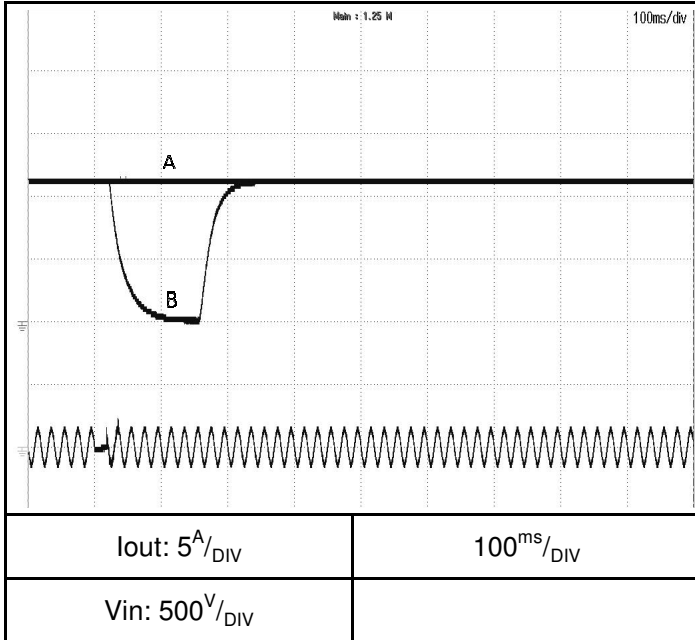

Brown-out time

A: 16mS
B: 17mS

G150-11.2

Vin:200VAC

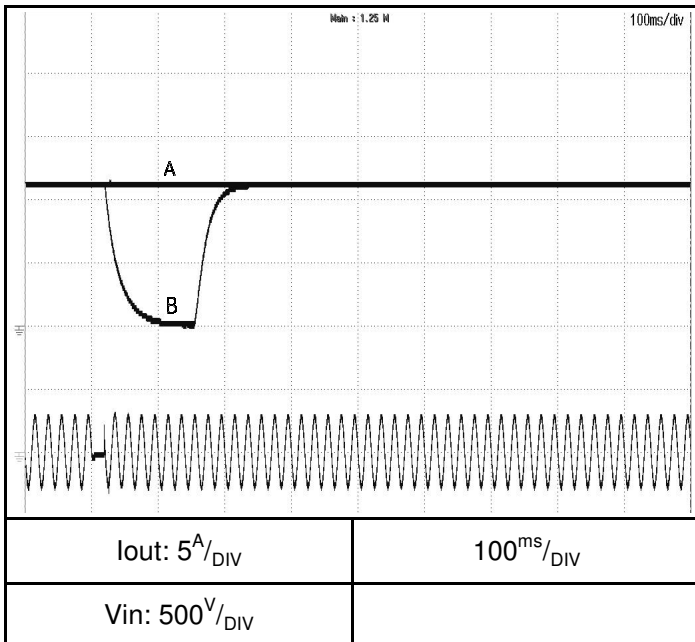

Brown-out time

A: 17mS
B: 18mS

2.9 Response to brown-out characteristics
C.C mode

Conditions:

Vout: 100%
Iout: 100%
Ta = 25°C

G600-2.8

Vin:100VAC

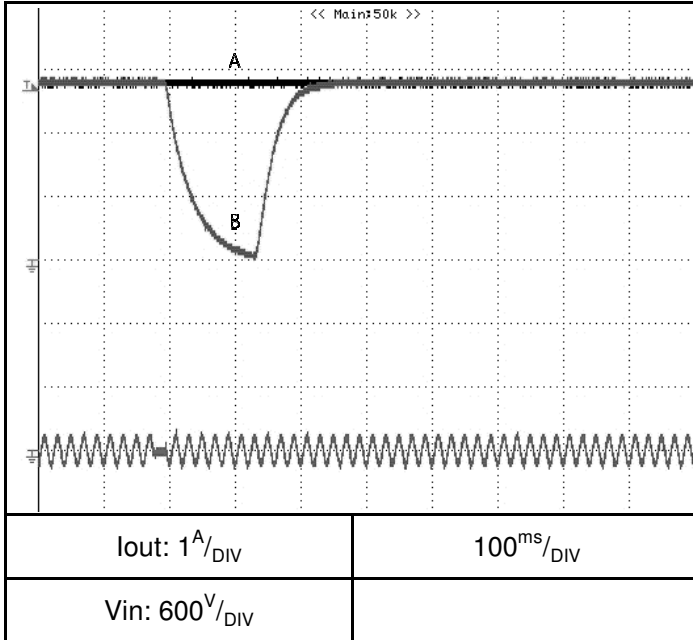

Brown-out time
A: 17mS
B: 18mS

G600-2.8

Vin:200VAC

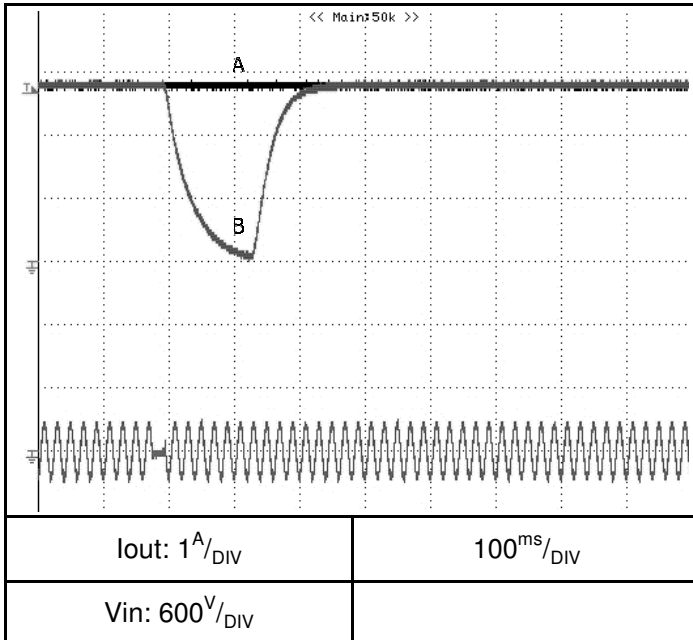

Brown-out time
A: 18mS
B: 19mS

2.10 Inrush Current Characteristics

Conditions: Vout: 100%

Iout: 0%

Iout: 100%

Vin: 100VAC

Ta = 25°C

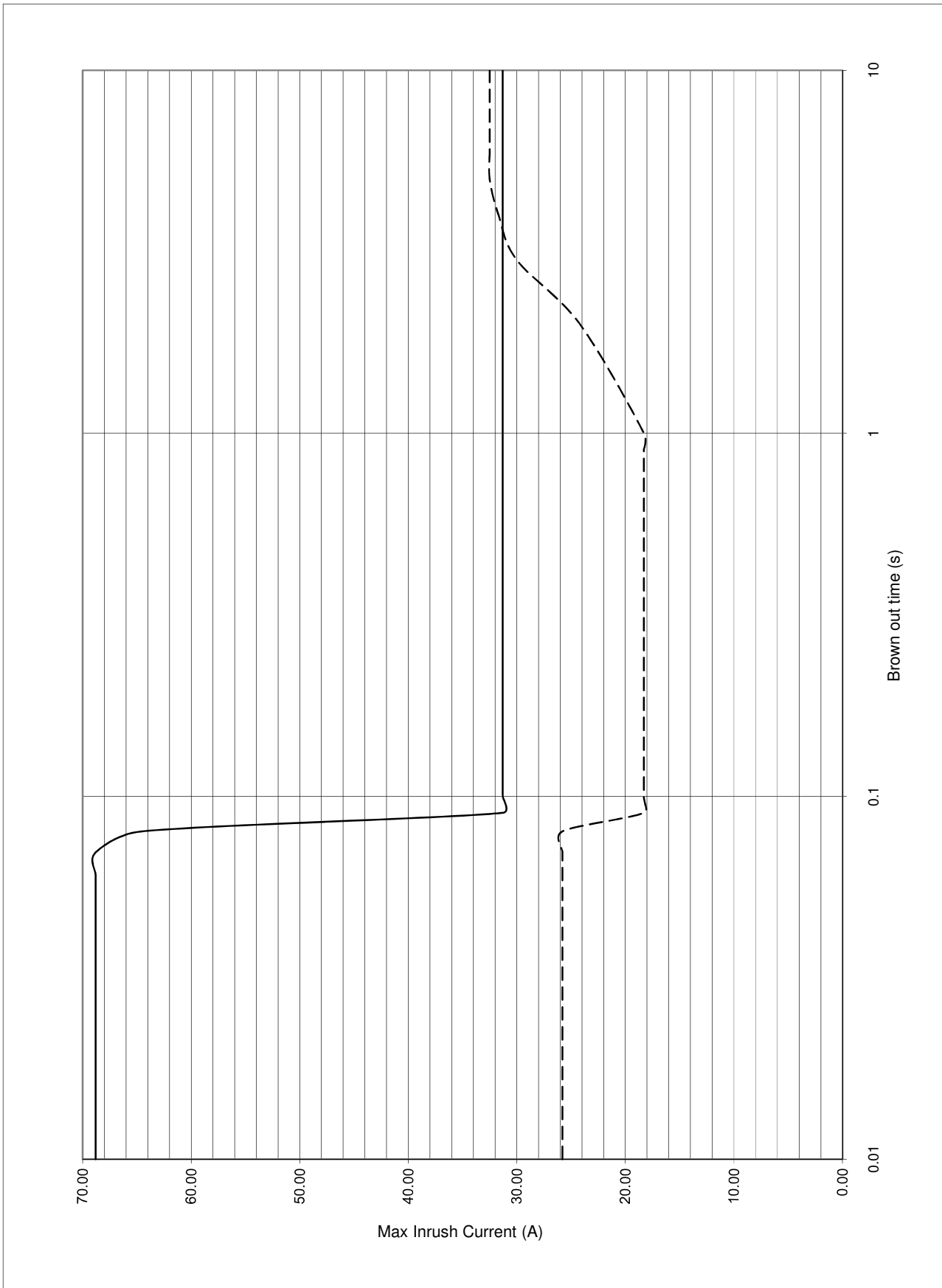

2.10 Inrush Current Characteristics

Conditions: Vout: 100%

Iout: 0%

Iout: 100%

Vin: 200VAC

Ta = 25°C

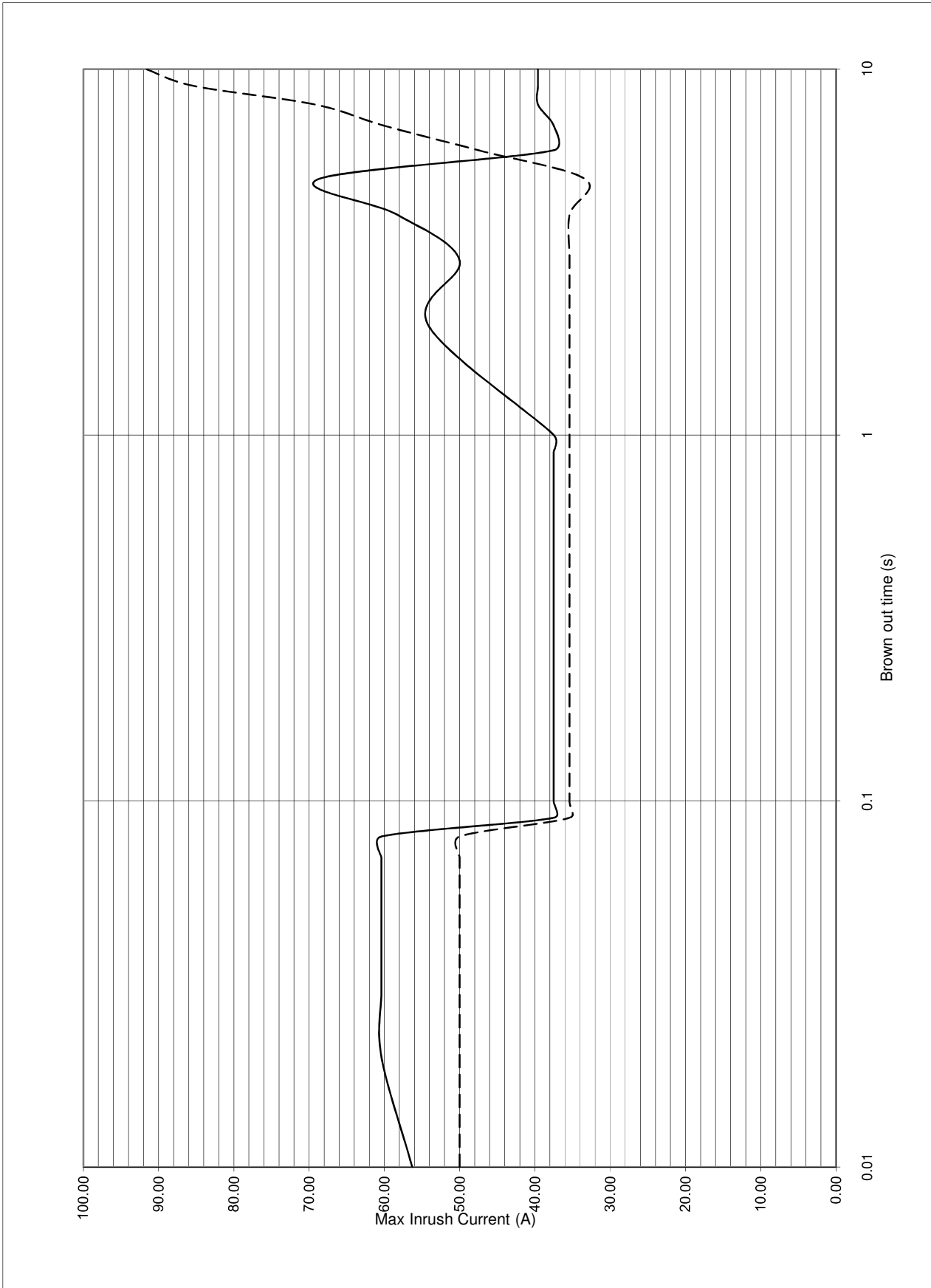

2.11 Inrush current waveform

Conditions: Vin: 100V
 Vout: 100%
 Iout: 100%
 Ta = 25°C

Switch on phase angle
 of input AC voltage
 $\phi=0^\circ$

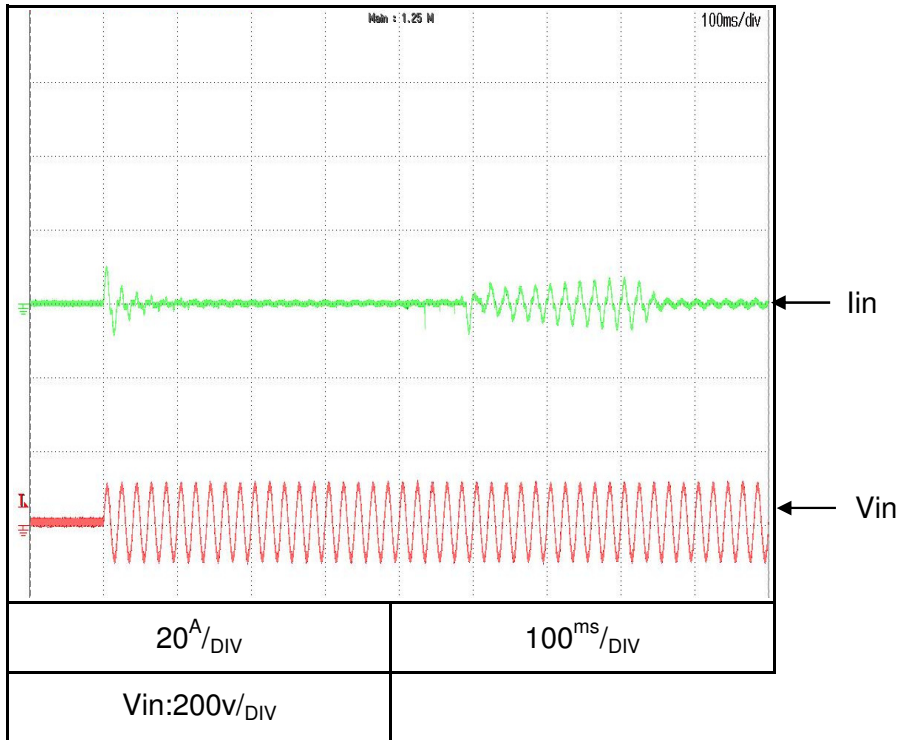

Switch on phase angle
 of input AC voltage
 $\phi=90^\circ$

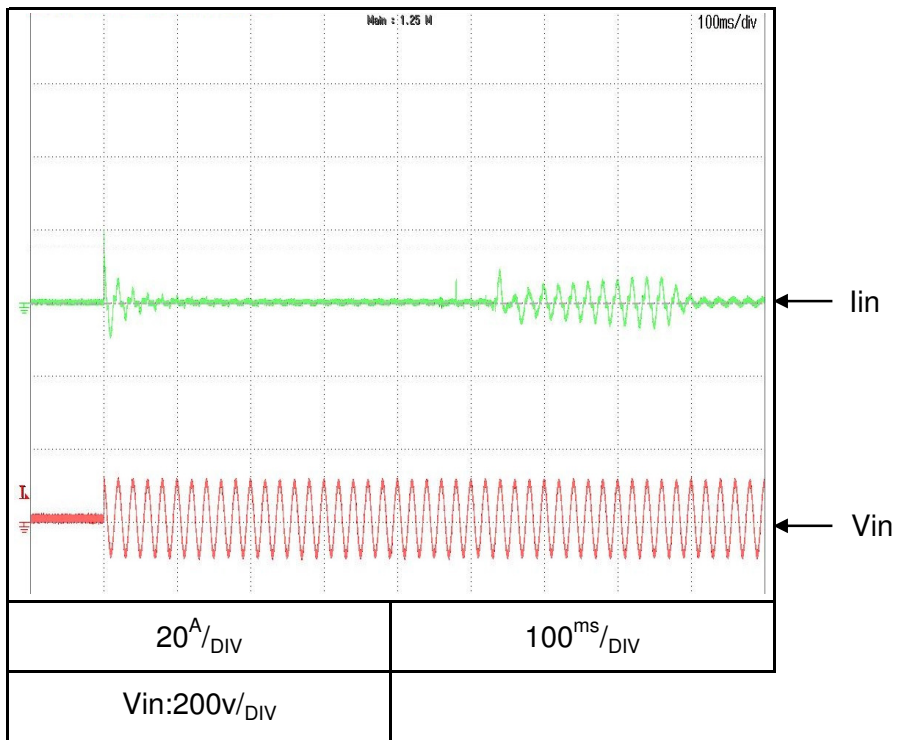

2.11 Inrush current waveform

Conditions: Vin: 200V
Vout: 100%
Iout: 100%
Ta = 25°C

Switch on phase angle
of input AC voltage

$\phi=0^\circ$

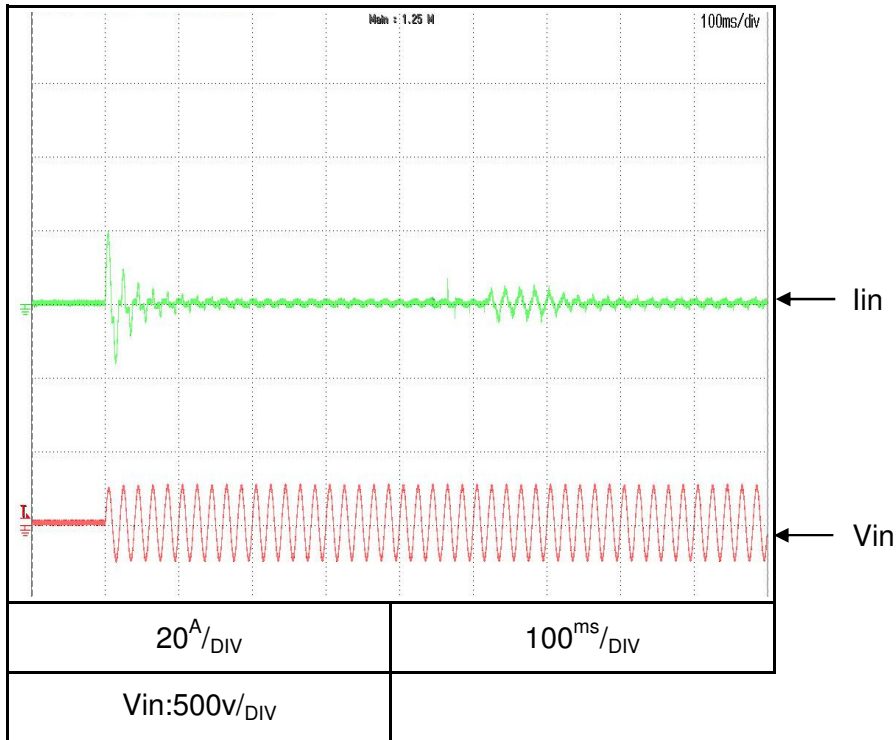

Switch on phase angle
of input AC voltage

$\phi=90^\circ$

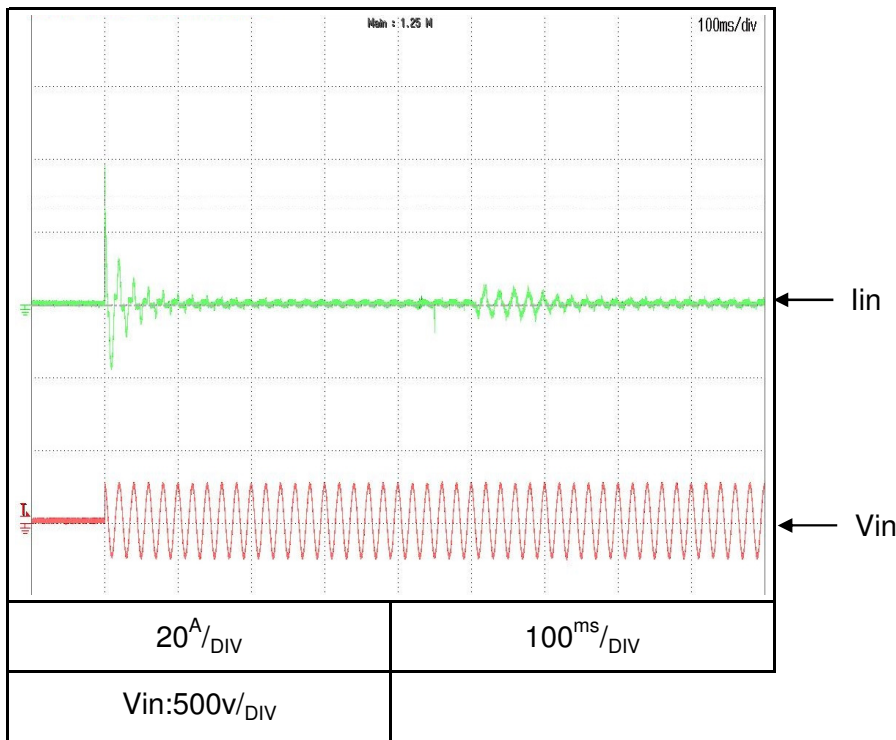

2.12 Input current waveform

Conditions: Vin: 100VAC
Vout: 100%
Iout: 100%
Ta = 25°C

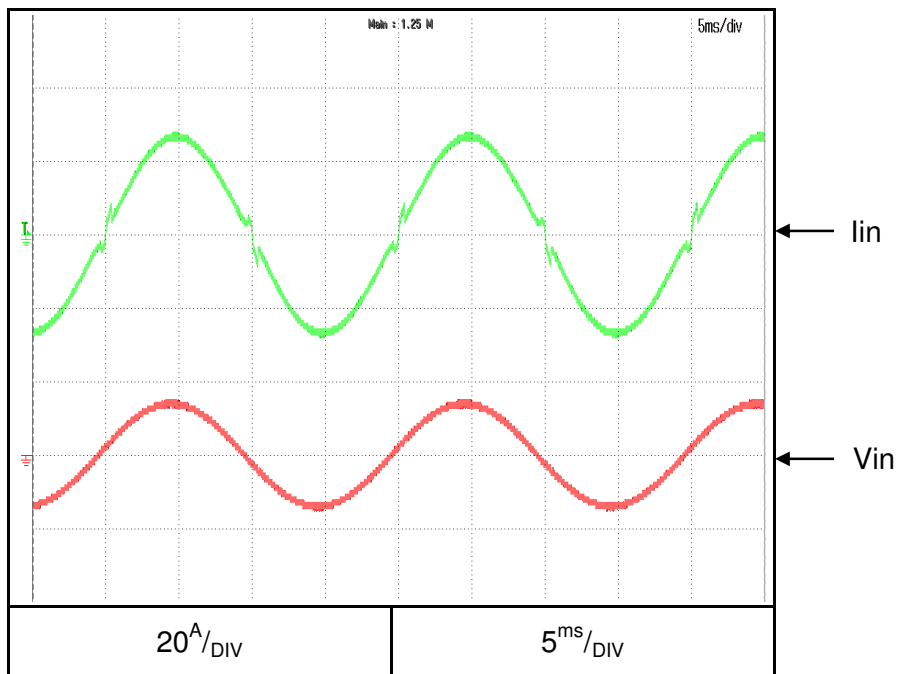

2.12 Input current waveform

Conditions: Vin: 200VAC
Vout: 100%
Iout: 100%
Ta = 25°C

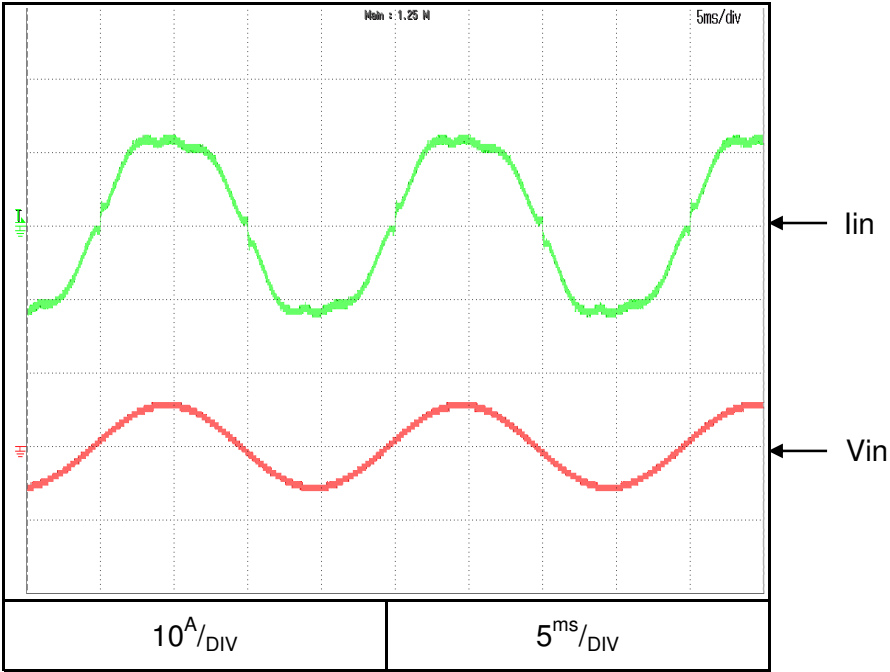

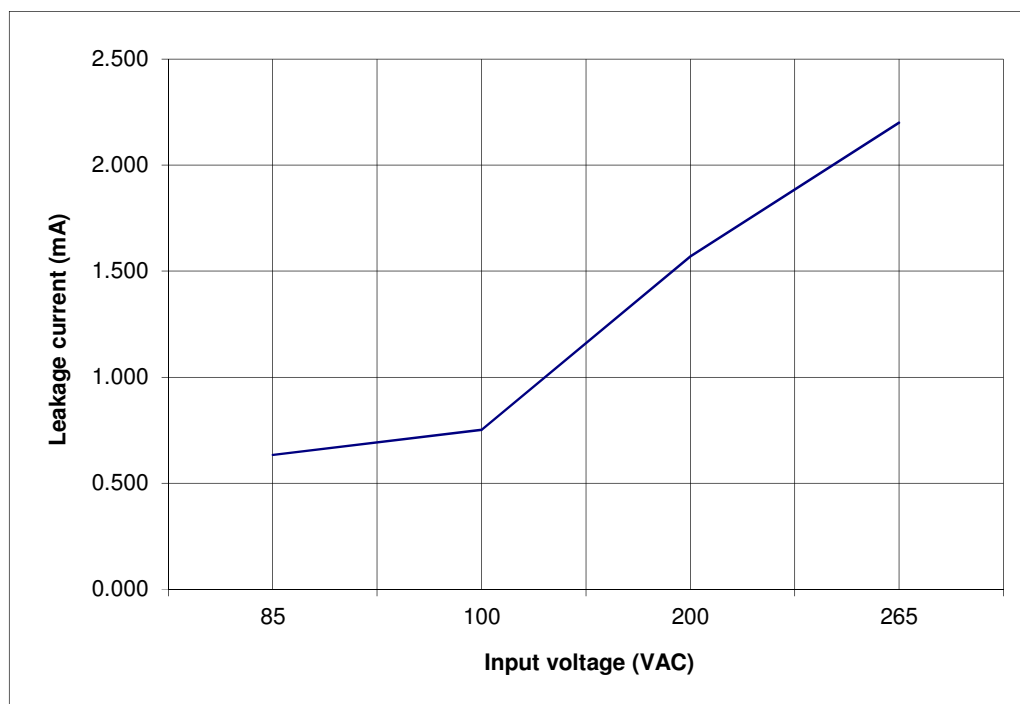
2.13 Leakage current characteristicsConditions: $T_a = 25^\circ\text{C}$
 $f=60\text{Hz}$ 

(*) TN & TT power system

2.14 Output ripple & noise waveform

C.V mode

Conditions: Vout: 100%

Iout: 100%

Ta = 25 °C

Normal Mode

G10-170

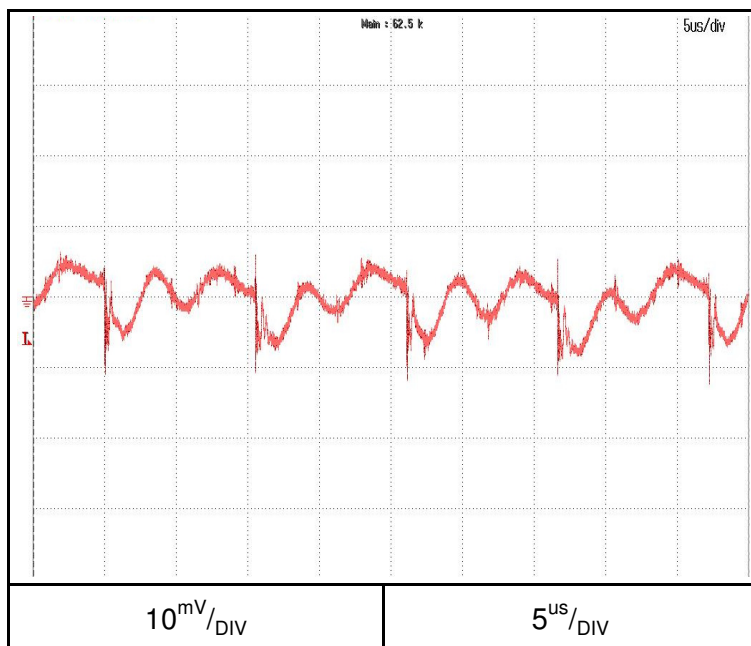

G60-28

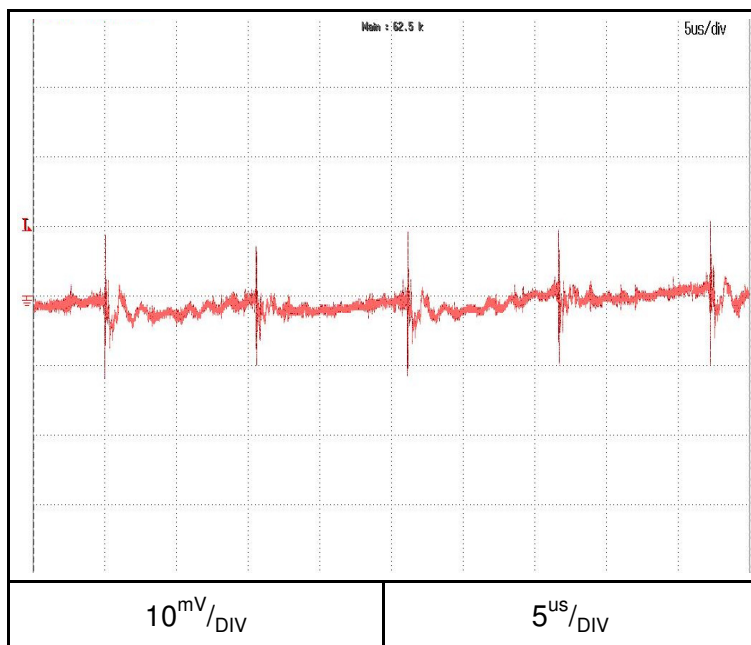

2.14 Output ripple & noise waveform

C.V mode

Conditions: Vout: 100%

Iout: 100%

Ta = 25 °C

Normal Mode

G150-11.2

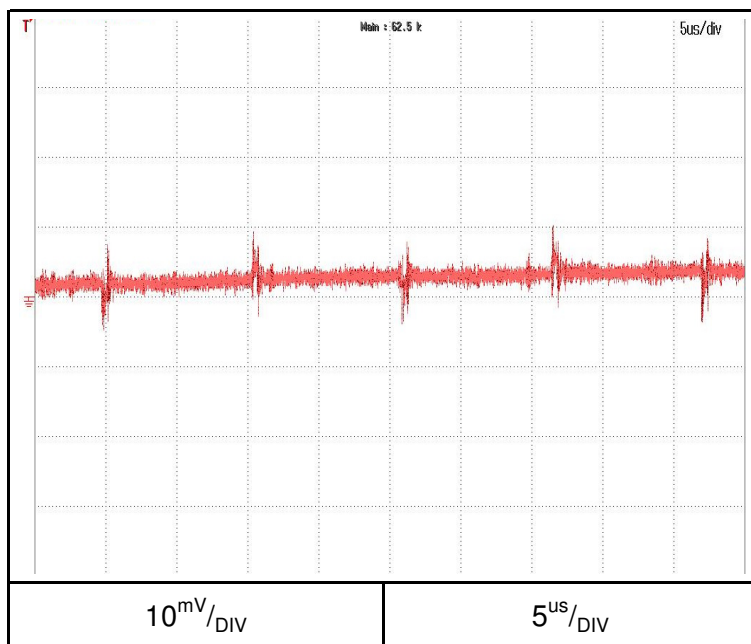

G600-2.8

