

**NON-ISOLATED DC-DC Converter**

**3.0-5.5V<sub>in</sub>, 0.9- 3.63V<sub>out</sub>, 15A**

**INSTALLATION / APPLICATION NOTE**

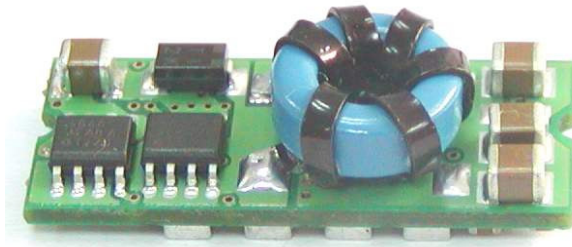

**PL15SMS-05C**

---

## Content

<b>1. INTRODUCTION</b>	<b>3</b>
<b>2. CONVERTER FEATURES</b>	<b>3</b>
<b>3. GENERAL DESCRIPTION</b>	<b>3</b>
3.1 Electrical Description	3
3.2 Thermal Packaging and Physical Design	3
<b>4. TECHNICAL SPECIFICATIONS</b>	<b>4</b>
<b>5. MAIN FEATURES AND FUNCTIONS</b>	<b>6</b>
5.1 Operating Temperature Range	6
5.2 Over-Temperature Protection (OTP)	6
5.3 Output Voltage Adjustment	6
5.4 Safe Operating Area (SOA)	6
5.5 Over Current Protection	6
5.6 Remote ON/OFF	6
5.7 UVLO (Under-Voltage Lockout)	6
<b>6. SAFETY</b>	<b>7</b>
6.1 Input Fusing and Safety	7
<b>7. APPLICATIONS</b>	<b>7</b>
7.1 Layout Design	7
7.2 Convection Cooling	8
7.3 Thermal Considerations	8
7.4 Power De-Rating Curves	9
7.5 Efficiency vs Load Curves	11
7.6 Input Capacitance	12
7.7 Test Set-Up	12
7.8 Remote Sense Compensation	12
7.9 Output Voltage Adjustment	13
7.10 Output Ripple and Noise Measurement	13
7.11 Output Capacitance	13
7.12 PL15SMS Reflow Profile	13
<b>8. MECHANICAL</b>	<b>14</b>
8.1 Outline Diagrams	14
8.2 SMS Tape and Reel Dimensions	14

## 1. Introduction

This application note describes the features and functions of Lambda's PL15SMS-05C series of Non Isolated DC-DC Converters. These "Point of Load" modules serve the needs specifically of the fixed and mobile telecommunications and computing markets. Capable of operating over a wide input voltage range of 3.0 – 5.5 VDC, this provides a precise regulated output voltage within the range of 0.9V to 3.63Vdc. The operating ambient temperature range is –40°C to +85°C. Ultra-high efficiency operation is achieved through the use of synchronous rectification. The modules are protected against short circuit and over-temperature conditions.

## 2. Converter Features

- High efficiency topology, typically 94% at 3.3Vdc
- Industry standard footprint
- Wide ambient temperature range, -40°C to +85°C
- Cost efficient open frame design
- Programmable output voltage via external resistor from 0.9 to 3.63Vdc
- No minimum load requirement (Stable at all loads)
- Remote ON/OFF
- Remote sense compensation
- Fixed switching frequency
- Continuous short-circuit protection and over current protection
- Over-temperature protection (OTP)
- Monotonic Startup with pre-bias at the output.
- UL/IEC/EN60950 Certified.

## 3. General Description

### 3.1 Electrical Description

A block diagram of the converter is shown in Figure 1. The topology is based on a non-isolated synchronous buck converter. The control loop is optimized for stability, fast transient response and a very tight line and load regulation. In a typical pre-bias application the converters do not draw any reverse current at start-up. The output voltage can be adjusted from 0.9 to 3.63vdc, using the TRIM pin with an external resistor. The converter can be shut down via a remote ON/OFF input that is referenced to ground. This input is compatible with readily available logic devices. A 'positive' logic input is supplied as standard. Positive logic implies that the converter is enabled if the remote ON/OFF input is high (or floating), and disabled if it is low.

The converter is also protected against over-temperature conditions. If the converter is overloaded or if the temperature of the converter exceeds its specified operating range, the converter will shut down and re-start once the fault is removed.

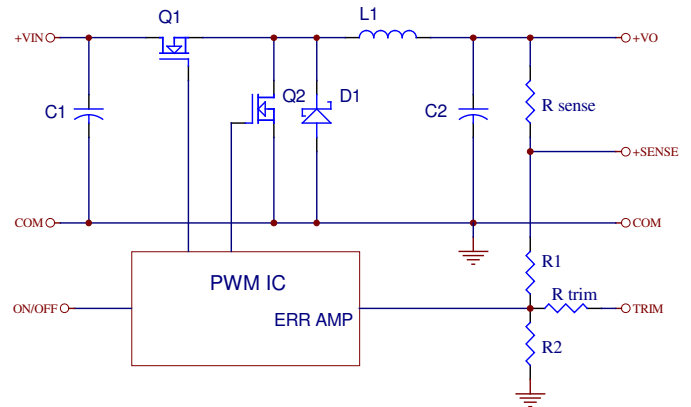

Figure 1. Electrical Block Diagram

### 3.2 Thermal Packaging and Physical Design

The converter uses a multi-layer FR4 PCB construction. All surface mount power components are placed on one side of the PCB and all other low-power components are placed on the opposite side; thus, the heat dissipation of the power components is optimized, ensuring that control components are not thermally stressed. The converter is an open-frame product and has no case or case pin. The open-frame design has several advantages over encapsulated closed devices. Among these advantages are:

- **Efficient Thermal Management:** the heat is removed from the heat generating components without heating more sensitive, small signal control components.
- **Environmental:** Lead free open-frame converters are more easily re-cycled.
- **Cost Efficient:** No encapsulation. Cost efficient open-frame construction.
- **Reliable:** Efficient cooling provided by open frame construction offers high reliability.

## 4. Technical Specifications

(All specifications are typical at nominal input, full load at 25°C unless otherwise noted.)

PARAMETER	NOTES and CONDITIONS	Device	Min.	Typical	Max.	Units
Operating Temperature		ALL	-40		+85	°C
Storage Temperature		ALL	-55		+125	°C
Operating Input Voltage		Vout =1.0V-2.7V Vout >2.7V-3.0V	3.0 4.5	5.0 5.0	5.5 5.5	Vdc
Input Under-Voltage Lockout						
Turn-On Voltage Threshold		ALL		2.8		Vdc
Turn-Off Voltage Threshold		ALL		2.7		Vdc
Lockout Hysteresis Voltage		ALL		0.1		Vdc
Maximum Input Current	Vin=3.0 to 5.5Vdc , Io=Io,max.	ALL			15.5	A
No-Load Input Current	Vo=1.0V Vo=1.2V Vo=1.5V Vo=1.8V Vo=2.0V Vo=2.5V Vo=3.3V	ALL		60 60 60 70 70 70 70		mA
Off Converter Input Current	Shutdown input idle current	ALL		5	10	mA
Inrush Current (I <sup>2</sup> t)		ALL			0.4	A <sup>2</sup> s
Input Reflected-Ripple Current	P-P thru 1uH inductor, 5Hz to 20MHz	ALL		150		mA
Output Voltage Set Point	Vin=Nominal Vin , Io=Io,max, Tc=25°C	ALL	-1.5%	Vo,set	+1.5%	Vdc
Output Voltage Trim Adjustment Range	Selected by an external resistor	ALL	0.9		3.63	Vdc
Output Voltage Regulation						
Load Regulation	Io=Io.min to Io,max	ALL	-0.5		+0.5	%
Line Regulation	Vin=low line to high line		-0.4		+0.4	%
Temperature Coefficient	Ta=-40° to 85°C	ALL			±0.03	%/°C
Output Voltage Ripple and Noise	5Hz to 20MHz bandwidth					
Peak-to-Peak	Full Load, 1uF ceramic and 10uF tantalum	ALL			50	mV
RMS	Full Load, 1uF ceramic and 10uF tantalum	ALL			20	mV
External Capacitive Load	Low ESR	ALL			10000	uF
Operating Output Current Range		ALL	0		15	A
Output DC Current-Limit Inception	Output Voltage =90% Nominal Output Voltage	ALL	18	22	28	A
Short Circuit Protection	Continuous with Hiccup Mode					

PARAMETER	NOTES and CONDITIONS	Device	Min.	Typical	Max.	Units
Output Voltage Transient Response						
Error Band	25% Step Load Change, di/dt=0.1A/us	ALL		±5		%
Setting Time (within 1% Vout nominal)	25% Step Load Change, di/dt=0.1A/us	ALL			200	us
100% Load	Vo=1.0V Vo=1.2V Vo=1.5V Vo=1.8V Vo=2.0V Vo=2.5V Vo=3.3V	ALL		82 84 87 88 89 92 94		%
Input to Output	Non-isolation		0			Vdc
Switching Frequency				300		kHz
ON/OFF Control, Positive Logic Remote On/Off Logic Low (Module Off) Logic High (Module On)	or Open Circuit	ALL	0		0.4 Vin	Vdc Vdc
ON/OFF Control, Negative Logic Remote On/Off Logic Low (Module On) Logic High (Module Off)	or Open Circuit	ALL	0 2.8		0.4 Vin	Vdc Vdc
ON/OFF Current (for both remote on/off logic)	Ion/off at Von/off=0.0V				1	mA
Leakage Current (for both remote on/off logic)	Logic High, Von/off=5V				1	mA
Turn-On Delay and Rise Time						
Turn-On Delay Time, From On/Off Control	Von/off to 10%Vo,set			1		ms
Turn-On Delay Time, From Input	Vin,min. to 10%Vo,set			1		ms
Output Voltage Rise Time	10%Vo,set to 90%Vo,set			3.5	6	ms
Over Temperature Protection				120		°C
MTBF	Io=100%of Io,max;Ta=25°C per MIL-HDBK-217F			1.5		M hours
Weight				6.8		grams

## 5. Main Features and Functions

### 5.1 Operating Temperature Range

The converters operate over a wide ambient temperature environment (-40°C to 85°C). Due consideration must be given to the de-rating curves when determining the maximum power that can be drawn from the converter. The maximum power drawn is influenced by a number of factors, such as:

- Input voltage range.
- Output load current.
- Air velocity (forced or natural convection).
- Mounting orientation of converter PCB with respect to the airflow.
- Motherboard PCB design, especially ground and power planes; these can be effective heat sinks for the converter.

### 5.2 Over-Temperature Protection (OTP)

The converters are equipped with non-latching over-temperature protection. A temperature sensor is located at the hottest point within the converter, typically on top of the switching device. If the temperature exceeds a threshold of 120°C (typical) the converter will shut down, disabling the output. When the temperature has decreased to a safe operating range, the converter will automatically start.

The over-temperature condition can be induced by a variety of reasons such as an external overload condition or a system fan failure.

### 5.3 Output Voltage Adjustment

Section 7.9 describes in detail how to trim the output voltage with respect to its set point. The output voltage on all models is adjustable over the range of 0.9 – 3.63Vdc.

### 5.4 Safe Operating Area (SOA)

Figure 2 provides a graphical representation of the Safe Operating Area (SOA) of the converter. This representation assumes ambient operating conditions such as airflow are met as per thermal guidelines provided in Sections 7.2 and 7.3.

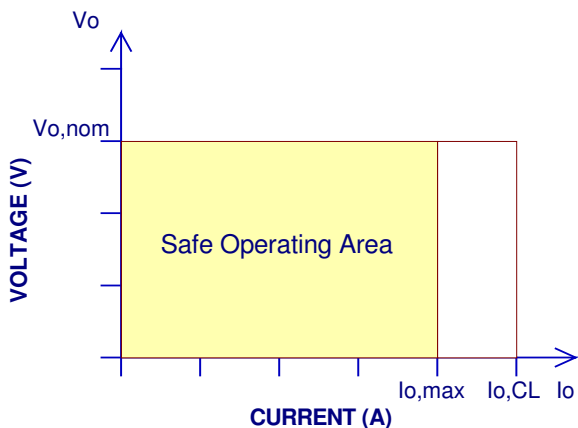

Figure 2. Maximum Output Current Safe Operating Area

### 5.5 Over Current Protection

All models have short-circuit and over current protection. The converter will automatically recover once either condition is removed. It will also supply up to 150% of its rated output current. In the event of an over current condition the converter will go into a hiccup mode.

### 5.6 Remote ON/OFF

**Positive Logic-**The remote ON/OFF input feature of the converter allows external circuitry to turn the converter ON or OFF. Active-high remote ON/OFF is available as standard. The converters are turned 'on' if the remote ON/OFF pin is high (=Vin), or left open. Setting the pin low (<0.4VDC) will turn the converter 'off'. The signal level of the remote on/off input is defined with respect to ground. If remote on/off is not needed, leave the remote on/off pin disconnected and the module will be on. **Negative Logic-** Designated with a suffix "N" is the Negative remote ON/OFF version. The unit is 'off' if this voltage level is above 2.8Vdc. The converter is 'on' if the on/off pin input is low (<0.4Vdc) or left open. The recommended remote on/off drive circuits are shown in figures 3 and 4.

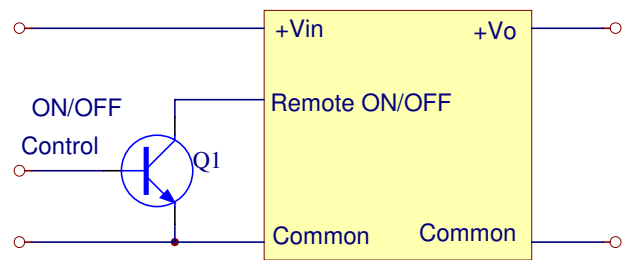

Figure 3. Positive Remote ON/OFF Input Drive Circuit

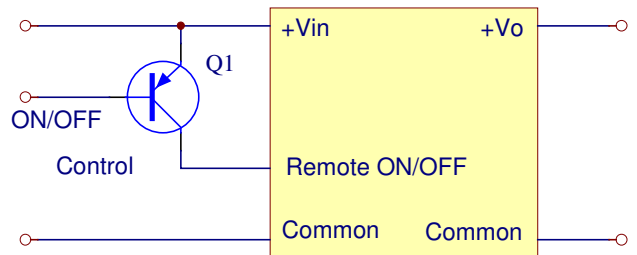

Figure 4. Negative Remote ON/OFF Input Drive Circuit

### 5.7 UVLO (Under-Voltage Lockout)

When the input Vcc rises and exceeds about 2.8V the converter initiates a soft start. The UVLO function in the converter has a hysteresis of approximately 100mV to provide noise immunity at start-up.

## 6. Safety

### 6.1 Input Fusing and Safety

These products are approved to UL 60950-1:2003, CAN/CSA C22.2 NO.60950-1:2003 and IEC/EN60950-1:2001.

These products are designed to be PCB mounted and for use within other equipment or enclosures. For safe installation and operation, carefully follow the instructions below:

Do not install, test, or operate the products near water or spill liquid on them.

Do not operate these products unless they are securely fastened.

These products must be installed in a restricted access location accessible to authorized personnel only.

These products must be professionally installed in accordance with the prevailing electrical wiring regulations and safety standards.

The output power taken from the unit must not exceed the ratings stated in the catalog datasheet.

Ensure adequate ventilation is provided to allow air to circulate.

This product has functional insulation between input and output and therefore the DC source to this product must be reinforced or double insulated to the AC input in accordance with IEC/EN 60950-1 to achieve SELV output.

Fusing – External ceramic sand-filled fuse, 250V, **F20A**, HBC.

## 7. Applications

### 7.1 Layout Design

In optimizing thermal design, the PCB is utilized as a heat sink. Some heat is transferred from the module to the main board through connecting pins. The system designer or the end user must ensure that other components and metal in the vicinity of the converter meet the spacing requirements to which the system is approved.

Low resistance and low inductance PCB layout traces are the norm and should be used where possible. Consideration must also be given to proper low impedance traces between power module and input / output grounds. The recommended footprint is shown in figure 5.

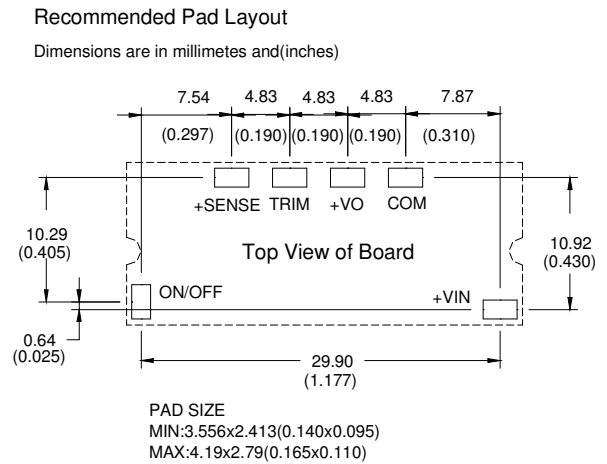

Figure 5. Recommended SMS Footprint

**7.2 Convection Cooling**

To predict the approximate cooling needed for the module, refer to the Power De-rating curves in Figures 8 and 9. These de-rating curves are approximations of the ambient temperatures and airflow required to keeping the power module temperature below its maximum rating. Once the module is assembled in the actual system, the module's temperature should be checked as shown in Figure 6 to ensure it does not exceed 110 °C.

Proper cooling can be verified by measuring the power module's temperature at Q1-pin 6 and Q2-pin 6 as shown in Figure 7.

**7.3 Thermal Considerations**

The power module operates in a variety of thermal environments; however, sufficient cooling should be provided to help ensure reliable operation of the unit. Heat is removed by conduction, convection, and radiation to the surrounding environment. The thermal data presented is based on measurements taken in a set-up as shown in Figure 6. Figures 8 and 9 represent the test data. Note that the airflow is parallel to the long axis of the module as shown in Figure 6.

The temperature at either location should not exceed 110 °C. The output power of the module should not exceed the rated power for the module (VO, set x IO, max). The PL15SMS thermal data presented is based on measurements taken in a wind tunnel.

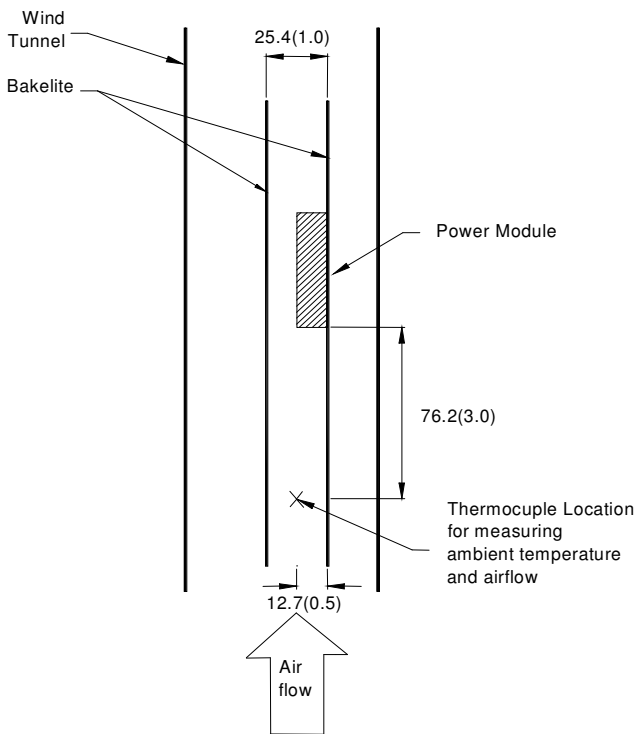

Note : Dimensions are in millimeters and (inches)

Figure 6. Thermal Test Setup

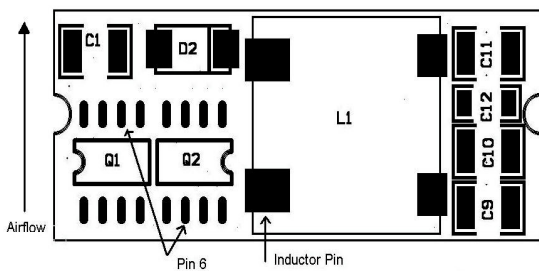

Figure 7. Temperature Measurement Location for SMS



**7.4 Power De-Rating Curves**

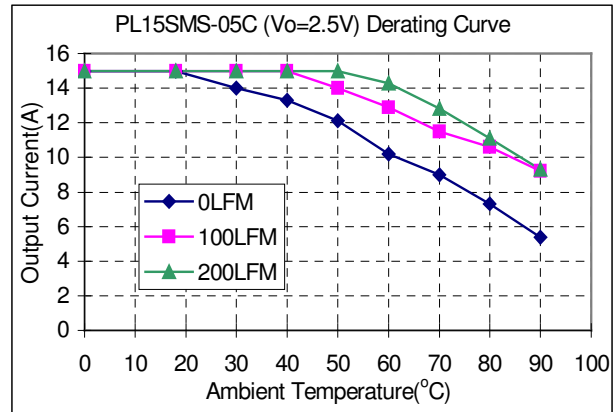
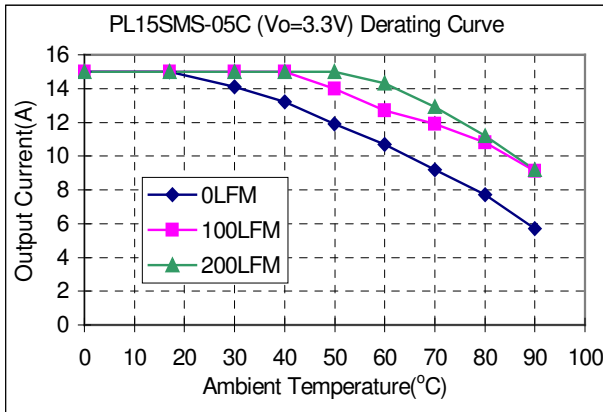

Figure 8a. Typical Power De-rating for 5V IN 3.3Vout

Figure 8b. Typical Power De-rating for 5V IN 2.5Vout

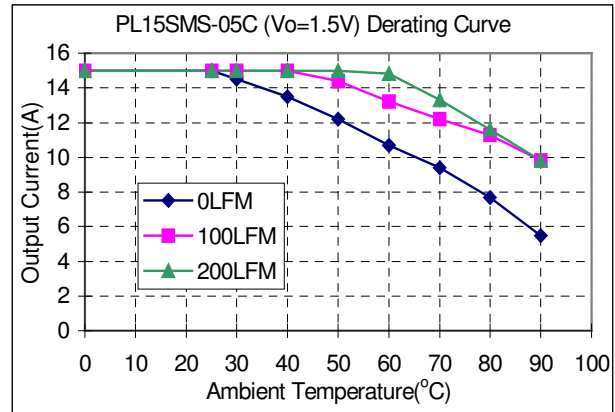
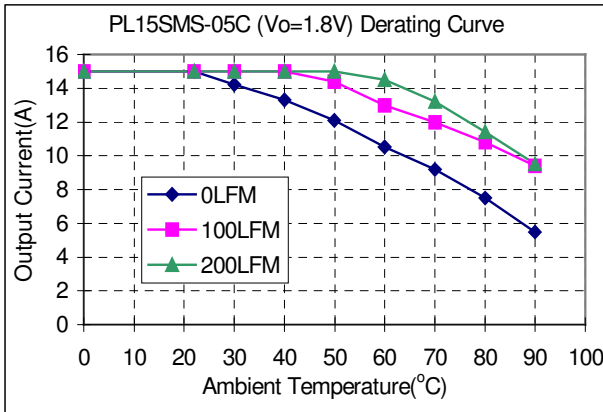

Figure 8c. Typical Power De-rating for 5V IN 1.8Vout

Figure 8d. Typical Power De-rating for 5V IN 1.5Vout

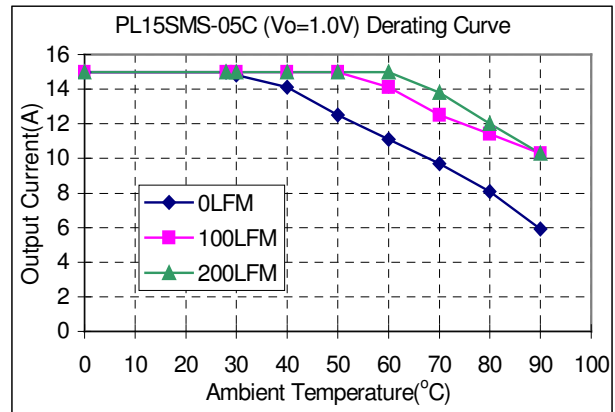
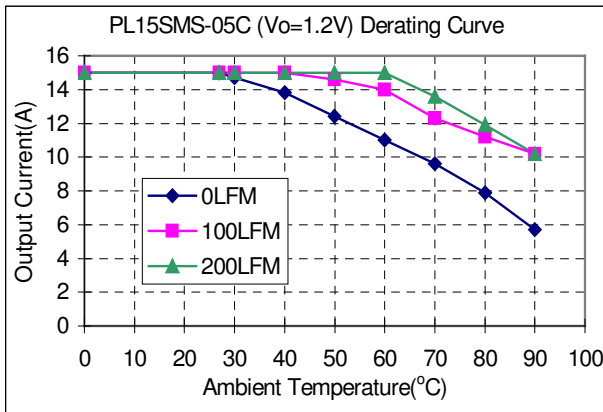

Figure 8e. Typical Power De-rating for 5V IN 1.2Vout

Figure 8f. Typical Power De-rating for 5V IN 1.0Vout

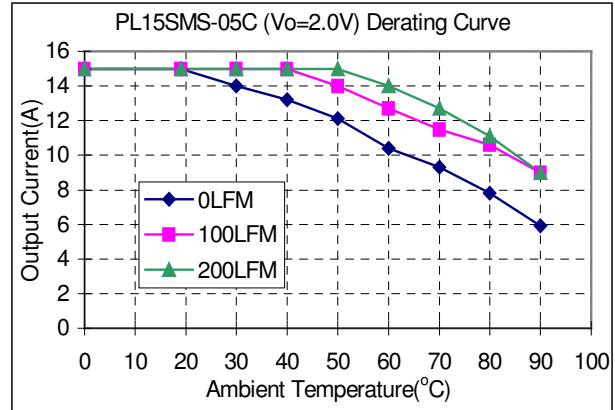
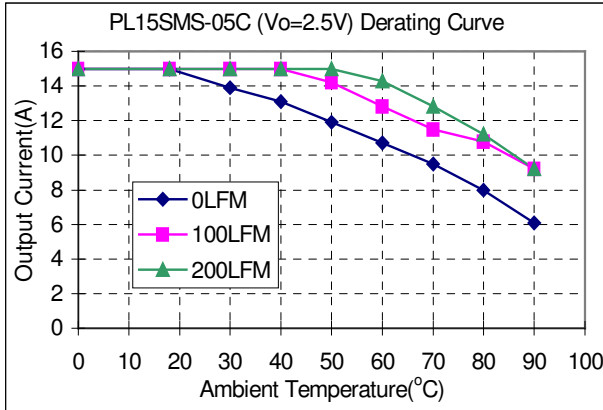

Figure 9a. Typical Power De-rating for 3.3V IN 2.5Vout

Figure 9b. Typical Power De-rating for 3.3V IN 2.0Vout

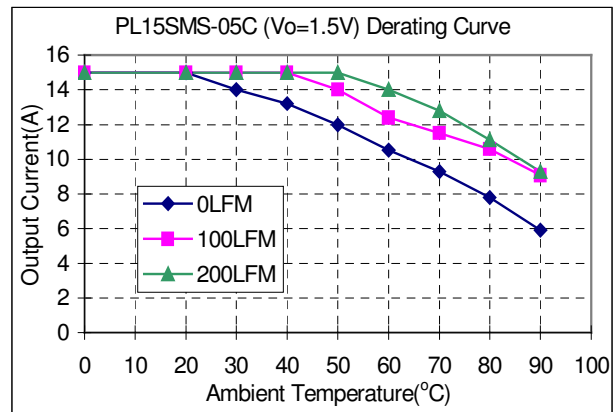
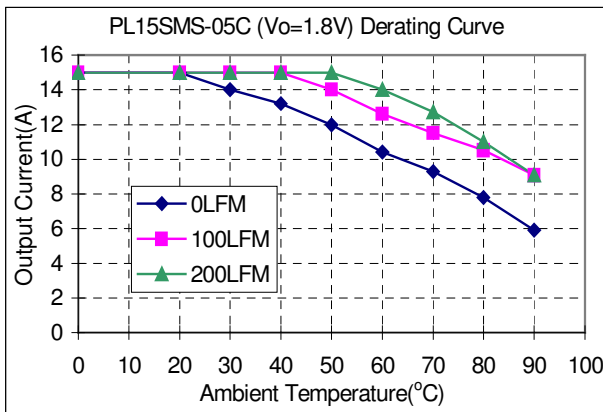

Figure 9c. Typical Power De-rating for 3.3V IN 1.8Vout

Figure 9d. Typical Power De-rating for 3.3V IN 1.5Vout

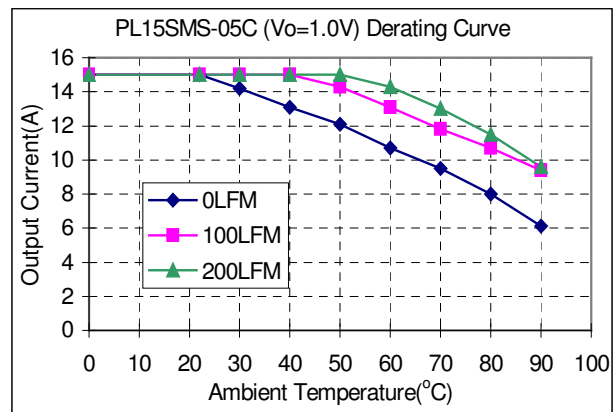
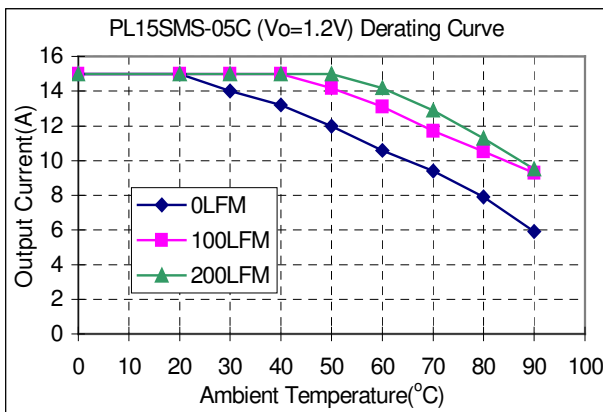
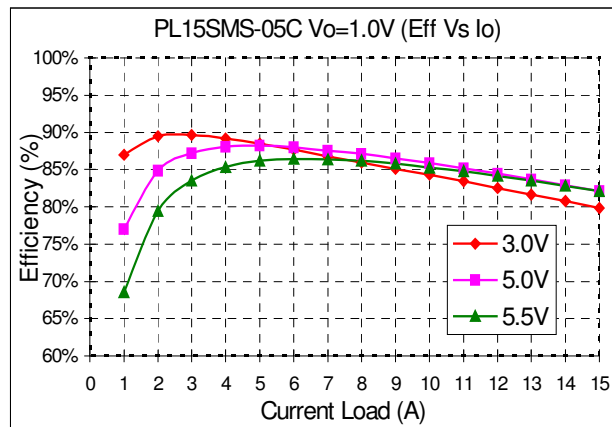
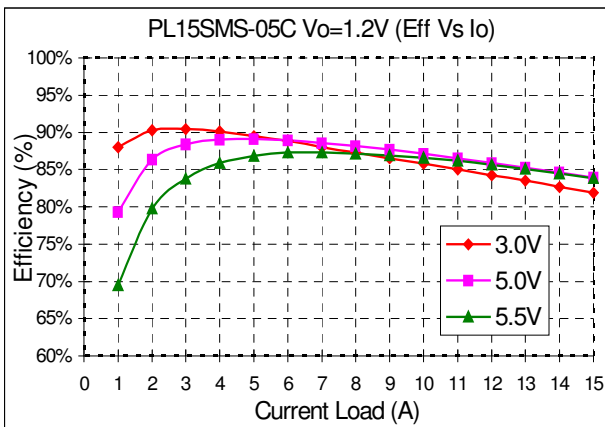
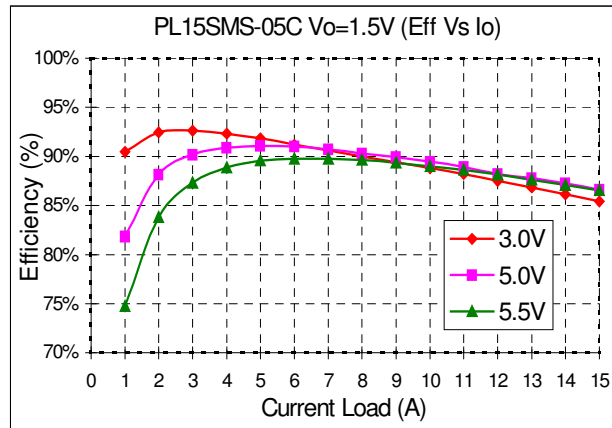
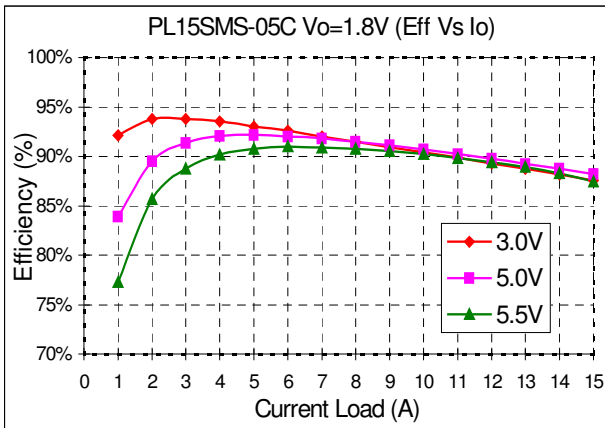
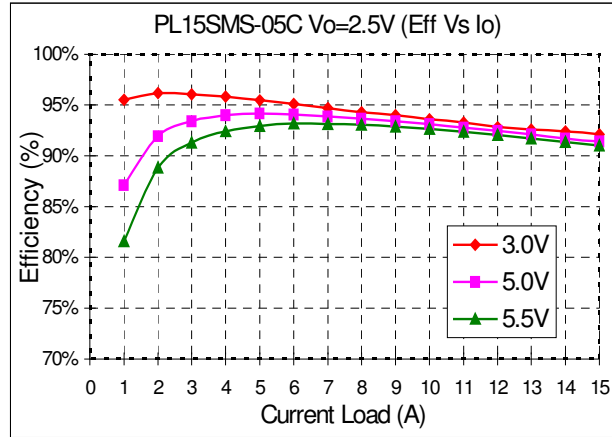
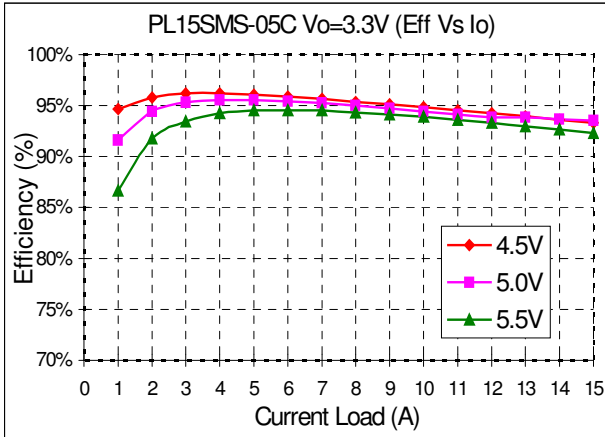

Figure 9e. Typical Power De-rating for 3.3V IN 1.2Vout

Figure 9f. Typical Power De-rating for 3.3V IN 1.0Vout

**7.5 Efficiency vs Load Curves**



## 7.6 Input Capacitance

The converters must be connected to a low source impedance to avoid problems with loop stability. The input capacitors should be placed close to the converter's input pins to reduce distribution inductance. Input capacitors should have a high capacitance and low ESR, (typically <20m ohms) for suitable ripple handling capability. Electrolytic capacitors should be avoided. The circuit as shown in Figure 10 represents typical measurement methods for ripple current. Input reflected-ripple current is measured with a simulated source inductance of 1uH. Current is measured at the input of the module.

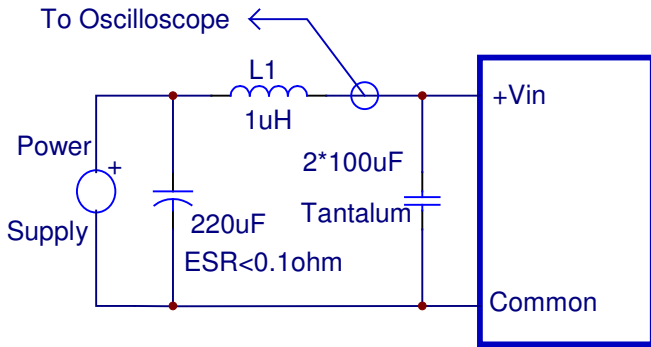

Figure 10. Input Reflected-Ripple Test Setup

## 7.7 Test Set-Up

The basic test set-up to measure parameters such as efficiency and load regulation is shown in Figure 11. Please note that this converter is non-isolated, as such the input and output share a common ground. These grounds should be connected together via low impedance ground plane in the application. When bench testing a converter, ensure that -Vin and -Vo are connected together via a low impedance short to ensure proper efficiency and load regulation measurements. When testing the converters under any transient conditions ensure that the transient response of the source is sufficient to power the equipment under test. We can calculate the

- Efficiency
- Load regulation and line regulation.

The value of efficiency is defined as:

$$\eta = \frac{V_o \times I_o}{V_{in} \times I_{in}} \times 100\%$$

Where:  $V_o$  is output voltage,  
 $I_o$  is output current,  
 $V_{in}$  is input voltage,  
 $I_{in}$  is input current.

The value of load regulation is defined as:

$$Load.reg = \frac{V_{FL} - V_{NL}}{V_{NL}} \times 100\%$$

Where:  $V_{FL}$  is the output voltage at full load  
 $V_{NL}$  is the output voltage at no load

The value of line regulation is defined as:

$$Line.reg = \frac{V_{HL} - V_{LL}}{V_{LL}} \times 100\%$$

Where:  $V_{HL}$  is the output voltage of maximum input voltage at full load.  
 $V_{LL}$  is the output voltage of minimum input voltage at full load.

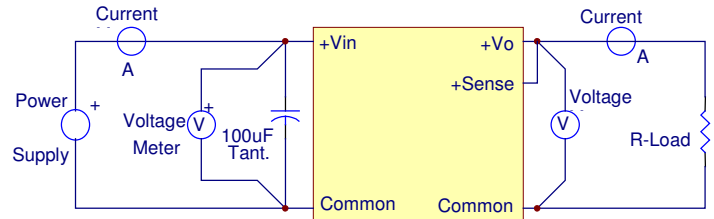

Figure 11. Test Setup

## 7.8 Remote Sense Compensation

The use of Remote Sense helps maintain the proper output voltage at the load. It minimizes the effects of distribution losses such as drops across the connectors and PCB traces (see Figure 12). The maximum drop from the output pin to the load should not exceed 500mV for remote compensation to work.

The amount of power delivered by the module is defined as the output voltage multiplied by the output current ( $V_o \times I_o$ ).

When using TRIM UP, the output voltage of the module will increase. If the same output current is maintained, the output power of the module will increase. Make sure that the maximum output power of the module remains at or below the maximum rated power.

When the Remote Sense feature is not being used the remote sense should be disconnected.

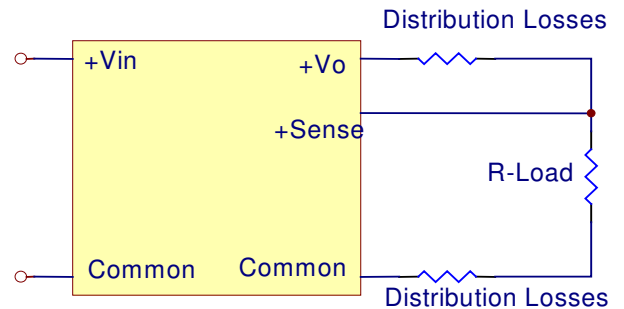

Figure 12. Circuit Configuration for Remote Sense Operation

## 7.9 Output Voltage Adjustment

The output Voltage of the converters can be adjusted over the range 0.9V to 3.63V by adding an external (shown as Rtrim) in Figure 13. When the Trim resistor is not connected the output voltage defaults to 0.75V

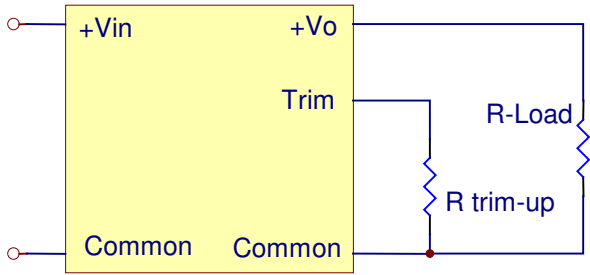

Figure 13. Trim-up Voltage Setup

The value of Rtrim-up defined as:

$$R_{trim} = \left( \frac{21070}{V_o - 0.75} - 5110 \right)$$

Where: Rtrim-up is the external resistor in ohms,  
Vo is the desired output voltage

To give an example of the above calculation, to set a voltage of 3.3Vdc, Rtrim is given by:

$$R_{trim} = \left( \frac{21070}{V_o - 0.75} - 5110 \right)$$

Rtrim = 3.153k ohms

Resistor values have been calculated for different voltages and listed in table 3.

Vo,set (V)	Rtrim (kohms)
0.90	135.36
1.00	79.17
1.20	41.71
1.50	22.98
1.80	14.96
2.00	11.75
2.50	6.93
3.30	3.15
3.63	2.20

Table 3 – Trim Resistor Values

## 7.10 Output Ripple and Noise Measurement

The test set-up for noise and ripple measurements is shown in Figure 14. A coaxial cable with a 50 ohm termination was used to prevent impedance mismatches.

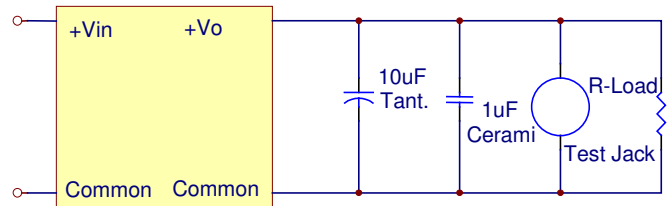

Figure 14. Output Voltage Ripple and Noise Measurement Set-Up

## 7.11 Output Capacitance

Lambda's converters provide a stable output with or without external capacitors. For good transient response, low ESR output capacitors should be located close to the load.

The converters are designed to work with load capacitance of up-to 10,000uF. It is recommended that any additional capacitance be typically 1,000uF and have a ESR of <20m ohms. This capacitor should be located close to the load.

## 7.12 PL15SMS Reflow Profile

An example of the SMS reflow profile is given in Figure 15.

**Equipment used:** SMD HOT AIR REFLOW HD-350SAR

**Alloy:** AMQ-M293TA or NC-SMQ92 IND-82088 SN63

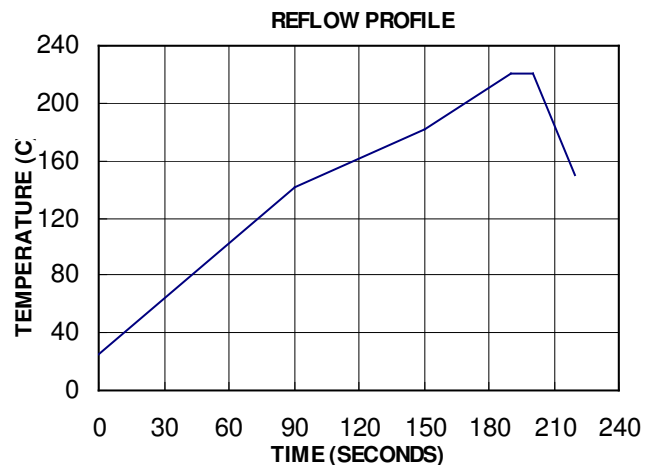

Figure 15 SMS Reflow Profile

**8. Mechanical**

**8.1 Outline Diagrams**

Dimensions are in millimeters and inches

Tolerance: x.xx ±0.02 in. (0.5mm) , x.xxx ±0.010 in. (0.25 mm) unless otherwise noted

**BOTTOM VIEW OF BOARD**

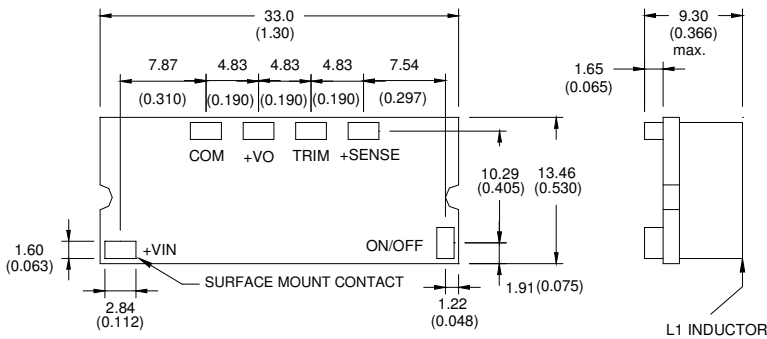

Dimensions are in millimeters(Inches)

Tolerances :X.X; 0.5mm(0.02in),X.XX; 0.25mm(0.010in),unless otherwise noted.

**Figure 16 Mechanical Outline Diagram**

**8.2 SMS Tape and Reel Dimensions**

The Tape Reel dimensions for the SMS module is shown in Figure 17.

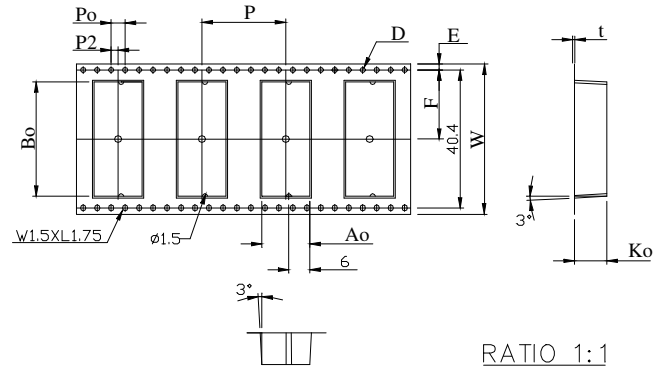

RATIO 1:1

ITEM	SPEC
W	44.00 <sup>+0.30</sup> <sub>-0.30</sub>
Ao	13.70 <sup>+0.10</sup> <sub>-0.10</sub>
Bo	33.50 <sup>+0.10</sup> <sub>-0.10</sub>
Ko	9.30 <sup>+0.10</sup> <sub>-0.10</sub>
P	24.00 <sup>+0.10</sup> <sub>-0.10</sub>
F	20.20 <sup>+0.10</sup> <sub>-0.10</sub>
E	1.75 <sup>+0.10</sup> <sub>-0.10</sub>
D	1.50 <sup>+0.10</sup> <sub>-0.00</sub>
D1	2.00 <sup>+0.25</sup> <sub>-0.00</sub>
Po	4.00 <sup>+0.10</sup> <sub>-0.10</sub>
P2	2.00 <sup>+0.10</sup> <sub>-0.10</sub>
t	0.40 <sup>+0.06</sup> <sub>-0.06</sub>

**Figure 17 – SMS Tape and Reel Dimensions**