

General Safety Instructions:

READ SAFETY INSTRUCTIONS

Servicing:

These products are not customer serviceable TDK-Lambda UK LTD and their authorised agents only are permitted to carry out repairs.

Critical Components:

These products are not authorised for use as critical components in nuclear control systems, life support systems or equipment for use in hazardous environments without the express written approval of the Managing Director of TDK-Lambda EMEA.

Product Usage:

These products are designed for use within a host equipment which restricts access to authorised competent personnel.

This product is a component power supply and is only to be installed by qualified persons within other equipment and must be not operated as a stand alone product.

This product is for sale to business to business customers and can be obtained via distribution channels.

It is not intended for sale to end users.

This product is a component power supply and does not fall within the scope of the EMC directive. Compliance with the EMC directive must be considered in the final installation. Please contact your local TDK-Lambda office.

Environmental:

These products are IPX0, and therefore chemicals/solvents, cleaning agents and other liquids must not be used.

Environment:

This power supply is a switch mode power supply for use in applications within a Pollution Degree 2, overvoltage category II environment. Material Group IIIb PCB's are used within it.

Output Loading:

The output power taken from the power supply must not exceed the rating stated on the power supply label, except as stated in the product limitations in this handbook.

Input Parameters:

This product must be operated within the input parameters stated in the product limitations in this handbook.

End of Life Disposal:

The unit contains components that require special disposal. Make sure that the unit is properly disposed of at the end of its service life and in accordance with local regulations.



RISK OF ELECTRIC SHOCK

High Voltage Warning:

Dangerous voltages are present within the power supply. The professional installer must protect service personnel from inadvertent contact with these dangerous voltages in the end equipment.

WARNING: When installed in a Class 1 end equipment, this product must be reliably earthed and professionally installed.

The (+) or (-) output(s) can be earthed or left floating.

The unit cover(s)/chassis (where applicable) must not be made user accessible.

The mains input connector is not acceptable for use as field wiring terminals.

For encased products, do not use mounting screws, which penetrate the unit more than; See drawings.

Internal fuses protect the unit and must not be replaced by the user. In case of internal defect, the unit must be returned to TDK-Lambda UK LTD or one of their authorised agents.

A suitable mechanical, electrical and fire enclosure must be provided by the end use equipment for mechanical, electric shock and fire hazard protection.

Energy Hazards:

The main output of this product is capable of providing hazardous energy (240VA). Final equipment manufacturers must provide protection to service personnel against inadvertent contact with the output terminals.

The unit cover/chassis, where applicable, is designed to protect skilled personnel from hazards. They must not be used as part of the external covers of any equipment where they may be accessible to operators, since under full load conditions, part or parts of the unit chassis may reach temperatures in excess of those considered safe for operator access.

Allgemeine Sicherheitsvorschriften:

LESEN SIE DIE SICHERHEITSVORSCHRIFTEN

Wartung:

Diese Produkte können nicht durch den Kunden gewartet werden. Nur TDK-Lambda UK LTD. und deren zugelassene Vertriebshändler sind zur Durchführung von Reparaturen berechtigt.

Kritische Komponenten:

Diese Produkte sind nicht für die Verwendung als kritische Komponenten in nuklearen Kontrollsystemen, Lebenserhaltungssystemen oder Geräten in gefährlichen Umgebungen geeignet, sofern dies nicht ausdrücklich und in Schriftform durch den Geschäftsführer von TDK-Lambda EMEA genehmigt wurde.

Produktverwendung:

Diese Produkte sind zur Verwendung innerhalb von Host-Anlagen gedacht, die einen auf das Fachpersonal beschränkten Zugang haben.

Dieses Produkt ist eine Stromversorgungs-Komponente und sie darf nur von qualifiziertem Personal in andere Geräte eingebaut werden und sie darf NICHT als eigenständiges ("Stand-Alone") Gerät betrieben werden.

Dieses Produkt ist für den Verkauf an Geschäftskunden entwickelt worden und es kann über Distributionskanäle bezogen werden.

Es ist NICHT für den Verkauf an Endkunden gedacht und konzipiert.

Dieses Produkt ist eine Stromversorgungsbaugruppe und sie fällt NICHT in den Bereich der EMV Direktive. Die Konformität mit der EMV Richtlinie muss in der finalen Gesamtinstallation betrachtet werden. Bitte kontaktieren Sie Ihr regionales TDK-Lambda Vertriebsbüro im Falle von Rückfragen.

Umwelt:

Diese Produkte sind IPX0, aus diesem Grund dürfen keine Chemikalien/Lösungsmittel, Reinigungsmittel und andere Flüssigkeiten verwendet werden.

Umgebung:

Dieses Netzteil ist ein Schaltnetzteil zur Verwendung in einer Umgebung mit einem Verschmutzungsgrad 2, Überspannungskategorie II. Materialgruppe IIIb mit darin verwendeten PCBs.

Ausgangsstrom:

Der Ausgangsstrom des Netztesiles darf die Leistung, die auf dem Label des Netztesiles vermerkt ist, nur dann überschreiten, wenn dies in den Produktgrenzen dieses Handbuches ausgezeichnet ist.

Eingangsparameter:

Dieses Produkt muss innerhalb der Eingangsparameter, die in den Produktgrenzen dieses Handbuches angegeben sind, betrieben werden.

Entsorgung am Ende der Betriebszeit:

Das Gerät enthält Komponenten die unter Sondermüll fallen. Das Gerät muss am Ende der Betriebszeit ordnungsgemäß und in Übereinstimmung mit den regionalen Bestimmungen entsorgt werden.

**GEFAHR DURCH ELEKTRISCHEN SCHLAG****Hochspannungswarnung:**

Innerhalb des Netztesiles gibt es gefährliche Spannungen. Der Elektroinstallateur muss das Wartungspersonal vor versehentlichem Kontakt mit den gefährlichen Spannungen im Endgerät schützen.

WARNUNG! Falls Sie unser Netzgerät in eine Anwendung mit Schutzklasse 1 eingebaut haben, stellen Sie sicher, dass es fachgerecht installiert und zuverlässig geerdet ist.

Die (+) oder (-) Ausgänge können geerdet werden oder unangeschlossen bleiben.

Die Abdeckung des Gerätes/das Gehäuse darf für den Benutzer nicht zugänglich sein.

Der Haupteingangsanschluss ist nicht für die Verwendung als Feldverdrahtungsanschluss geeignet.

Für ummantelt Produkte, verwenden Sie keine Schrauben, die das Gerät mehr als durchdringen; siehe Zeichnung. Eine interne Sicherung schützt das Gerät und darf durch den Benutzer nicht ausgetauscht werden. Im Fall von internen Defekten muss das Gerät an TDK-Lambda UK LTD oder einen der autorisierten Vertriebs Händler zurückgeschickt werden.

Ein geeignetes mechanisches, elektrisches und brandgeschütztes Gehäuse muss als Schutz vor der Gefahr von mechanischen Risiken, Stromschlägen und Brandschutz in dem Endgerät vorgesehen werden.

Gefahren durch elektrische Energie:

Von bestimmten Modulen kann je nach Einstellung der Ausgangsspannung gefährliche elektrische Energie ausgehen (240 VA). Die Endgerätehersteller müssen einen Schutz für Servicepersonal vor unbeabsichtigtem Kontakt mit den Ausgangsanschlüssen dieser Module vorsehen. Kann aufgrund der Einstellung gefährliche elektrische Energie auftreten, dürfen die Modulanschlüsse für den Benutzer nicht zugänglich sein.

Die Geräteabdeckung/das Gehäuse ist so entworfen, dass das Fachpersonal vor Gefahren geschützt wird. Sie dürfen nicht als Teil der externen Abdeckung für Geräte verwendet werden, die für den Betreiber zugänglich sein müssen, da Teile oder das gesamte Gerätegehäuse unter voller Auslastung übermäßige Temperaturen erreichen kann, die für den Zugang des Betreibers nicht mehr als sicher betrachtet werden.

Consignes générales de sécurité:

LIRE LES CONSIGNES DE SECURITE

Entretien:

Ces produits ne peuvent pas être réparés par l'utilisateur. Seuls, TDK-Lambda UK LTD et ses agents agréés sont autorisés à effectuer des réparations.

Composants critiques:

Ces produits ne doivent pas être utilisés en tant que composants critiques dans des systèmes de commande nucléaire, dans des systèmes de sauvetage ou dans des équipements utilisés dans des environnements dangereux, sans l'autorisation écrite expresse du directeur général de TDK-Lambda EMEA.

Utilisation du produit:

Ces produits sont conçus pour être utilisés dans un équipement hôte dont l'accès n'est autorisé qu'aux personnes compétentes.

Ce produit est une alimentation considérée comme un composant devant être installé par des personnes qualifiées, dans un autre équipement. Il ne doit pas être utilisé en tant que produit fini.

Ce produit est destiné à la vente entre entreprises et peut être obtenu via des canaux de distribution.

Il n'est pas prévu à la vente pour les particuliers.

Ce produit est une alimentation considérée comme un composant, il ne relève pas du champ d'application de la directive CEM. Le respect de la directive CEM doit être pris en compte dans l'installation finale. Veuillez contacter votre bureau TDK-Lambda le plus proche.

Environnement:

Ces produits sont IPX0, et donc on ne doit pas utiliser des produits chimiques/solvants, des produits de nettoyage et d'autres liquides.

Environnement fonctionnel :

Cette alimentation fonctionne en mode commutation pour utilisation dans des applications fonctionnant dans un environnement avec Degré de Pollution 2 et catégorie de surtension II. Elle utilise des cartes des circuits imprimés (PCB) de Groupe IIIb.

Intensité soutirée:

L'intensité soutirée de l'alimentation ne doit pas dépasser l'intensité nominale marquée sur la plaque signalétique, sauf indications contraires dans les limitations du produit décrit dans ce manuel.

Paramètres d'entrée:

Ce produit doit être utilisé à l'intérieur des paramètres d'entrée indiqués dans les limitations du produit dans ce manuel.

Elimination en fin de vie:

L'alimentation contient des composants nécessitant des dispositions spéciales pour leur élimination. Vérifiez que cette alimentation est mise au rebut correctement en fin de vie utile et conformément aux réglementations locales en vigueur.



RISQUE DE CHOC ELECTRIQUE

Attention-Danger haute tension:

Des tensions dangereuses sont présentes dans l'alimentation. L'installateur doit protéger le personnel d'entretien contre un contact involontaire avec ces tensions dangereuses dans l'équipement final.

AVERTISSEMENT: Si ce produit est installé dans un équipement final de classe I, il doit être mis à la terre de manière fiable et installé par un professionnel averti.

Les sorties (+) ou (-) peuvent être raccordées à la terre ou laissées flottantes.

Le couvercle/châssis de l'alimentation ne doit pas être accessible à l'utilisateur. Le connecteur d'entrée d'alimentation principale ne doit pas être utilisé comme borne de raccordement.

N'utilisez pas de vis pénétrant dans le module sur une profondeur supérieure à : Voir dessins.

Un fusible interne protège le module et ne doit pas être remplacé par l'utilisateur. En cas de défaut interne, le module doit être renvoyé à TDK-Lambda UK LTD ou l'un de ses agents agréés.

Une enceinte appropriée doit être prévue par l'utilisateur final pour assurer la protection contre les chocs mécaniques, les chocs électriques et l'incendie.

Energies dangereuses :

Certains modules peuvent générer une énergie dangereuse (240 VA) selon le réglage de tension de sortie. Le fabricant de l'équipement final doit assurer la protection des techniciens d'entretien contre un contact involontaire avec les bornes de sortie de ces modules. Si une telle tension dangereuse risque de se produire, les bornes ou les connexions du module ne doivent pas être accessibles par l'utilisateur.

Le couvercle et le châssis du module sont conçus pour protéger des personnels expérimentés. Ils ne doivent pas être utilisés comme couvercles extérieurs d'un équipement, accessible aux opérateurs car en condition de puissance maximum, des parties du châssis peuvent atteindre des températures considérées comme dangereuses pour l'opérateur.

Norme generali di sicurezza:

SI PREGA DI LEGGERE LE NORME DI SICUREZZA

Manutenzione:

Il cliente non può eseguire alcuna manutenzione su questi prodotti. L'esecuzione delle eventuali riparazioni è consentita solo a TDK-Lambda UK LTD e ai suoi agenti autorizzati.

Componenti critici:

Non si autorizza l'uso di questi prodotti come componenti critici all'interno di sistemi di controllo nucleari, sistemi necessari alla sopravvivenza o apparecchiature destinate all'impiego in ambienti pericolosi, senza l'esplicita approvazione scritta dell'Amministratore Delegato di TDK-Lambda EMEA.

Uso dei prodotti:

Questi prodotti sono progettati per l'uso all'interno di un'apparecchiatura ospite che limiti l'accesso al solo personale competente e autorizzato.

Questo prodotto è da considerarsi come un alimentatore professionale componente e come tale deve essere installato da personale qualificato all'interno di altre apparecchiature e non può essere utilizzato come prodotto indipendente.

Questo prodotto non è inteso per la vendita al dettaglio o agli utilizzatori finali.

Questo alimentatore è da considerarsi come un componente e come tale non è assoggettato dagli scopi della direttiva EMC. Conformità alla direttiva EMC deve essere considerata nell'installazione finale di utilizzo. Gli uffici di TDK-Lambda Sas Succursale Italiana sono a vostra disposizione per ulteriori raggugli.

Condizioni ambientali:

Questi prodotti sono classificati come IPX0, dunque non devono essere utilizzati sostanze chimiche/solventi, prodotti per la pulizia o liquidi di altra natura.

Ambiente:

Questo prodotto è un alimentatore a commutazione, destinato all'uso in applicazioni rientranti in ambienti con le seguenti caratteristiche: Livello inquinamento 2, Categoria sovratensione II. Questo prodotto contiene schede di circuiti stampati in materiali di Gruppo IIIb.

Carico in uscita:

La potenza in uscita ottenuta dall'alimentatore non deve superare la potenza nominale indicata sulla targhetta dell'alimentatore, fatto salvo dove indicato nei limiti per il prodotto specificati in questo manuale.

Parametri di alimentazione:

Questo prodotto deve essere utilizzato entro i parametri di alimentazione indicati nei limiti per il prodotto, specificati in questo manuale.

Smaltimento:

L'unità contiene componenti che richiedono procedure speciali di smaltimento. Accertarsi che l'unità venga smaltita in modo corretto al termine della vita utile e nel rispetto delle normative locali.



RISCHIO DI SCOSSA ELETTRICA

Avvertimento di alta tensione:

All'interno dell'alimentatore sono presenti tensioni pericolose. Gli installatori professionali devono proteggere il personale di manutenzione dal rischio di contatto accidentale con queste tensioni pericolose all'interno dell'apparecchiatura finale.

ATTENZIONE: Se installato in un'attrezzatura di classe I, questo prodotto deve essere collegato a terra in modo affidabile ed installato in modo professionale.

Le uscite (+) o (-) possono essere messa a terra o lasciate isolate.

I coperchi/il telaio dell'unità non devono essere accessibili da parte dell'utente.

Il connettore dell'alimentazione principale non può essere utilizzato come terminale di collegamento di campo.

Non utilizzare viti che penetrano nell'unità per più di : Vedi disegni

Un fusibile interno protegge l'unità e non deve essere sostituito dall'utente. Nell'eventualità di un difetto interno, restituire l'unità a TDK-Lambda UK LTD o a uno dei suoi agenti autorizzati.

L'apparecchiatura finale deve includere una recinzione meccanica, elettrica e antincendio per proteggere dai pericoli di natura meccanica, dalle scosse elettriche e dai pericoli di incendio.

Pericoli energetici:

Alcuni moduli sono in grado di erogare energia pericolosa (240 VA) a seconda della tensione in uscita impostata. I produttori delle apparecchiature finali sono tenuti a proteggere il personale di manutenzione dal rischio di contatto accidentale con questi terminali dei moduli di uscita. Se impostati su livelli che non escludono l'erogazione di energia pericolosa, questi terminali o collegamenti non devono risultare accessibili da parte dell'utente.

Il coperchio/telaio dell'unità è realizzato per proteggere il personale esperto dai pericoli. Non deve essere usato come parte degli involucri esterni di qualsiasi apparecchiatura, se risulta accessibile da parte degli addetti, poiché è possibile che in condizioni di pieno carico una o più parti del telaio dell'unità giunga/ giungano a temperature superiori ai limiti considerati sicuri per l'accesso da parte degli addetti.

Instrucciones generales de seguridad:

LEA LAS INSTRUCCIONES DE SEGURIDAD

Servicio:

Estos productos no pueden ser reparados por los clientes. TDK-Lambda UK LTD. y sus agentes autorizados son los únicos que pueden llevar a cabo las reparaciones.

Componentes fundamentales:

Estos productos no pueden ser utilizados como componentes fundamentales en sistemas de control nuclear, sistemas de soporte vital o equipos a utilizar en entornos peligrosos sin el consentimiento expreso por escrito del Director General de TDK-Lambda EMEA.

Uso de los productos:

Estos productos han sido diseñados para ser utilizados en un equipo central que restrinja el acceso al personal cualificado autorizado.

Este producto es una fuente de alimentación y sólo puede ser instalado por personal cualificado dentro de otros equipos y no debe ser tratado como un producto independiente. Este producto debe ser vendido entre empresas profesionales y solo puede obtenerse a través de los canales de distribución. No está destinado para la venta a usuarios finales.

Este producto es una fuente de alimentación y no se ve afectada por la directiva EMC. El cumplimiento de la directiva EMC se debe considerar en la instalación final. Por favor, póngase en contacto con su oficina local de TDK - Lambda.

Medioambiental:

Estos productos son IPX0 y, por tanto, no pueden utilizarse sustancias químicas/disolventes, agentes de limpieza ni otros líquidos.

Medio ambiente:

Esta fuente de alimentación es una fuente de alimentación de modo conmutado a utilizar en aplicaciones dentro de un entorno con un Grado de contaminación 2 y una Categoría de sobretensión II. En él se utilizan policloruros de bifenilo del Grupo de materiales IIIb.

Carga de salida:

La potencia de salida tomada de la fuente de alimentación no puede sobrepasar el valor nominal indicado en la etiqueta de la fuente de alimentación, excepto en los casos indicados en las limitaciones del producto en este manual.

Parámetros de entrada:

Este producto debe ser utilizado dentro de los parámetros de entrada indicados en las limitaciones del producto en este manual.

Desecho de la unidad:

La unidad contiene componentes que deben ser desechados de una manera especial. Asegúrese de desechar correctamente la unidad al final de su vida útil y conforme a las normas locales vigentes.



PELIGRO DE DESCARGAS ELÉCTRICAS

Advertencia de alta tensión:

En esta fuente de alimentación hay tensiones peligrosas. El instalador profesional debe proteger al personal de servicio contra cualquier contacto accidental con estas tensiones peligrosas en el equipo final.

ADVERTENCIA: La instalación de este producto en un equipo de clase I la deben llevar a cabo profesionales y el producto debe estar conectado a tierra.

La salida o salidas (+) o (-) pueden conectarse a tierra o se las puede dejar flotando.

Debe impedirse el acceso de los usuarios a la cubierta o cubiertas y al chasis de la unidad.

El conector de entrada de la red no es apto para ser utilizado a modo de bornes de cableado de campo.

No utilice tornillos de montaje susceptibles de penetrar en la unidad más de: Ver dibujos.

Un fusible interno protege la unidad y este no debe ser nunca reemplazado por el usuario. En caso de existir algún defecto interno, la unidad debe ser enviada a TDK-Lambda UK LTD o a uno de sus agentes autorizados.

El equipo de uso final debe constituir un recinto de protección mecánica, eléctrica y contra incendios de protección mecánica, contra descargas eléctricas y contra el peligro de incendios.

Peligros de energía:

Algunos módulos pueden generar energía peligrosa (240VA) dependiendo de la configuración de la tensión de salida. Los fabricantes de equipos finales deben proteger al personal de servicio contra un contacto accidental con estos bornes de salida de los módulos. Si se configura de modo que pueda generarse energía peligrosa, hay que evitar que el usuario pueda acceder a los bornes o conexiones del módulo.

La cubierta/chasis de la unidad ha sido diseñada para que proteja a las personas cualificadas de los peligros. No deben ser utilizadas como parte de las cubiertas externas de cualquier equipo al que pueden acceder los operarios, ya que bajo unas condiciones de carga completa, la pieza o piezas del chasis de la unidad pueden alcanzar temperaturas superiores a las consideradas seguras para el acceso de los operarios.

Instruções gerais de segurança:

LEIA AS INSTRUÇÕES DE SEGURANÇA

Manutenção:

Estes produtos não são podem ser submetidos a manutenção por parte do cliente. Apenas a TDK-Lambda UK LTD e os seus agentes autorizados têm permissão para realizar reparações.

Componentes essenciais:

Não é autorizada a utilização destes produtos como componentes essenciais de sistemas de controlo nuclear, sistemas de suporte de vida ou equipamento para utilização em ambientes perigosos sem a expressa autorização por escrito do Director-Geral da TDK-Lambda EMEA.

Utilização do produto:

Estes produtos foram concebidos para utilização dentro de um equipamento de alojamento que apenas permita o acesso a pessoal qualificado autorizado.

Este produto é uma alimentação considerado com um componente para ser instalado por pessoas qualificadas, em outros equipamentos. Não deve ser usado como um produto acabado.

Este produto é destinado para venda entre as empresas e pode ser obtido através de canais de distribuição. Não se destina à venda aos particulares.

Este produto é uma alimentação considerado com um componente, não é dentro do application âmbito da directiva CEM.

Conformidade com a directiva CEM devem ser considerados na instalação final.

Entre em contacto com seu escritório TDK-Lambda mais próximo.

Ambiental:

Estes produtos são IPX0 e, como tal, não se devem utilizar químicos/solventes, agentes de limpeza e outros líquidos.

Ambiente:

Esta fonte de alimentação é uma fonte de alimentação do modo de comutação para utilização em aplicações com um Nível de Poluição 2 e ambientes da categoria de sobretensão II. São utilizadas placas de circuitos impressos do grupo de materiais IIIb.

Carga de saída:

A potência de saída extraída da fonte de alimentação não deve exceder a classificação assinalada na etiqueta da fonte de alimentação, excepto quando indicado nas limitações do produto neste guia.

Parâmetros de entrada:

Este produto deve ser utilizado dentro dos parâmetros de entrada indicados nas limitações do produto neste guia.

Eliminação no fim de vida:

A unidade contém componentes que necessitam de procedimentos especiais de eliminação. Certifique-se de que a unidade é devidamente eliminada no fim da sua vida útil e que tal é feito em conformidade com os regulamentos locais.



RISCO DE CHOQUE ELÉCTRICO

Aviso de alta tensão:

Estão presentes tensões perigosas dentro da fonte de alimentação. O profissional que realizar a instalação deve proteger o pessoal de assistência contra contactos inadvertidos com estas tensões perigosas do equipamento final.

AVISO: Quando instalado num equipamento de Classe I, este produto deve ser ligado à terra de forma fiável e instalado por um profissional.

As saídas (+) e (-) podem ser ligadas à terra ou deixadas soltas.

O chassis/cobertura(s) da unidade não deve estar acessível ao utilizador.

O conector de entrada de alimentação não deve ser utilizado como terminal de cablagens no local.

Não utilize parafusos de montagem, uma vez que estes penetrarão na unidade em mais do que: Veja os desenhos

Existe um fusível interno que protege a unidade e que não deve ser substituído pelo utilizador. Em caso de defeito interno, a unidade deve ser devolvida à TDK-Lambda UK LTD ou a um dos seus agentes autorizados.

O equipamento de utilização final deve fornecer um bastidor com protecção mecânica, eléctrica e contra incêndios adequada.

Perigos de energia:

Alguns módulos tem a capacidade de fornecer energia perigosa (240 VA), de acordo com a configuração da tensão de saída. O equipamento final do fabricante deve garantir que o pessoal de assistência está protegido contra contactos inadvertidos com estes terminais de saída do módulo. Se essa energia perigosa for produzida, as ligações e os terminais do módulo não devem ser acessíveis pelos utilizadores.

O chassis/cobertura da unidade está concebido de forma a proteger o pessoal especializado de perigos. Não devem ser utilizados como parte das coberturas externas de qualquer equipamento em que possam estar acessíveis aos operadores, uma vez que em condições de carga máxima, algumas peças do chassis da unidade podem atingir temperaturas superiores às consideradas seguras para o acesso do operador.

TDK-Lambda

TDK-Lambda UK Ltd
Kingsley Avenue, Ilfracombe
Devon, EX34 8ES
Telephone - Sales and Service +44 (0)1271 856666
Head Office and Works +44 (0)1271 856600
Facsimile +44 (0)1271 864894
WEBSITE: www.uk.tdk-lambda.com

EZA2500 Series

INSTRUCTION MANUAL

BEFORE USING THE POWER SUPPLY UNIT (Common)

Be sure to read this instruction manual thoroughly before using this product. Pay attention to all cautions and warnings before using this product. Incorrect usage could lead to an electrical shock, damage to the unit or a fire hazard.

DANGER

Never use this product in locations where flammable gas or ignitable substances are present.

INSTALLATION WARNING

- When installing, ensure that work is done in accordance with the instruction manual. When installation is improper, there is risk of electric shock and fire.
- Installation shall be done by Service personnel with necessary and appropriate technical training and experience. There is a risk of electric shock and fire.
- Do not cover the product with cloth or paper etc. Do not place anything flammable around. This might cause damage, electric shock or fire.

WARNING on USE

- Do not touch this product or its internal components while circuit in operation, or shortly after shutdown. You may receive a burn.
- While this product is operating, keep your hands and face away from it as you may be injured by an unexpected situation.
- There are cases where high voltage charge remains inside the product. Therefore, do not touch even if they are not in operation as you might get injured due to high voltage and high temperature.
You might also get electric shock or burn.
- Do not make unauthorized changes to this product nor remove the cover as you might get an electric shock or might damage the product. We will not be held responsible after the product has been modified, changed or dis-assembled.
- Do not use this product under unusual condition such as emission of smoke or abnormal smell and sound etc. Please stop using it immediately and shut off the product.
It might lead to fire and electric shock. In such cases, please contact us. Do not attempt repair by yourself, as it is dangerous for the user.
- Do not operate and store these products in environments where condensation occurs due to moisture and humidity. It might lead fire and electric shock.
- Do not drop or apply shock to this product. It might cause failure. Do not operate these products mechanical stress is applied.

CAUTION on MOUNTING

- Confirm connections to input/output terminals are correct as indicated in the instruction manual before switching on.
- Input voltage, Output current, Output power, ambient temperature and ambient humidity should be kept within specifications, otherwise the product will be damaged, or cause electric shock or fire.
- Do not use this product in special environment with strong electromagnetic field, corrosive gas or conductive substances and direct sunlight, or places where product is exposed to water or rain.
- Mount this product properly in accordance with the instruction manual, mounting direction and shall be properly be ventilated.
- Please shut down the input when connecting input and output of the product.
- The power supply may cause damage when it intake conductive material, dust and liquid. When use this product, please be careful to prevent entry of those materials to inside the product by using filter etc.
- Do not use this product in environments where causes the salt damage.

CAUTION on USE

- Product individual notes are shown in the instruction manual. If there is any difference with common notes individual notes shall have priority.
- Before using this product, be sure to read the catalog and instruction manual. There is risk of electric shock or damage to the product or fire due to improper use.
- Input voltage, Output current, Output power, ambient temperature and ambient humidity should be kept within specifications, otherwise the product will be damaged, or cause electric shock or fire.
- If the built-in fuse is blown, do not use the product even after replacing the fuse as there is risk of abnormality inside. Be sure to request repair to our company.

- For products without built-in protection circuit (element, fuse, etc.), insert fuse at the input to prevent smoke, fire during abnormal operation.
As for products with built-in protection circuit, depending on usage conditions, built-in protection circuit might not work. It is recommended to provide separate proper protection circuit.
- For externally mounted fuse do not use other fuses aside from our specified and recommended fuse.
- This product was made for general purpose electronic equipment for standard industrial use and is not designed for applications requiring high safety (such as extremely high reliability and safety requirements. Even though high reliability and safety are not required, this product should not be used directly for applications that have serious risk for life and physical safety. Take sufficient consideration in fail-safe design (such as providing protective circuit or protective device inside the system, providing redundant circuit to ensure no instability when single device failure occurs).
- When used in environments with strong electromagnetic field, there is possibility of product damage due to malfunction.
- When used in environment with corrosive gas (hydrogen sulfide, sulfur dioxide, etc.) , there is possibility that they might penetrate the product and lead to failure.
- When used in environments where there is conductive foreign matter or dust, there is possibility of product failure or malfunction.
- Provide countermeasure for prevention of lightning surge voltage as there is risk of damage due to abnormal voltage.
- Connect together the frame ground terminal of the product and the ground terminal of the equipment for safety and noise reduction. If these ground is not connected together, there is risk of electric shock.
- Parts with lifetime specifications (built-in fan, electrolytic capacitor) are required to be replaced periodically.
Set the overhaul period depending on the environment of usage and perform maintenance.
Also, note that there are cases when EOL products cannot be overhauled.
- Take care not to apply external abnormal voltage to the output. Especially, applying reverse voltage or overvoltage more than the rated voltage to the output might cause failure, electric shock or fire.
- Do not use in special environment such as places directly exposed to sunlight, dew condensation, moisture, rain, strong electro-magnetic field, or corrosive gas (hydrogen sulfide, sulfur dioxide).
- This product have a built-in fan for air-cooling. Do not block the air intake and exhaust.
- The output of this product is considered to be a hazardous energy level (The voltage is 2V or more and the power is 240VA or more). It must not be made accessible to users. Protection must be provided for Service Engineers against indirect contact with the output terminals and/or to prevent tools being dropped across them. While working on this product, the DC input power must be switched off and the input and output voltage should be zero.
- When short the output during operation, there is a damage inside the converter.
- When change abrupt in Input voltage during operation, there is a Risk of damage inside the converter.
- When use the Electric storage device, Please refer to the manual of electric storage device and use the appropriate protection device.

 **Note**

- There is a possibility machining traces remain on sheet metal of product.
- Consider storage of the product at normal temperature and humidity avoiding direct exposure to sunlight at environment with minimal temperature and humidity changes. Storage of product at high temperature, high humidity and environments with severe changes in temperature and humidity might cause deterioration, and occurrence of condensation in the product.
- When disposing product, follow disposal laws of each municipality.
- Published EMI (CE, RE) or immunity is the result when measured in our standard measurement conditions and might not satisfy specification when mounted and wired inside end-user equipment.
Use the product after sufficiently evaluating at actual end-user equipment.
- Catalogue, contents of the instruction manual may be changed without a prior notice. Refer to latest catalogue or instruction manual.
- Reproduction or reprinting the instruction manual or its portion is forbidden without our permission.

1. Over View

1-1. System Construction Example

Example of power conversion system is below. This example is constructed in Manual CV Mode meaning the power conversion direction is controlled by Host System.

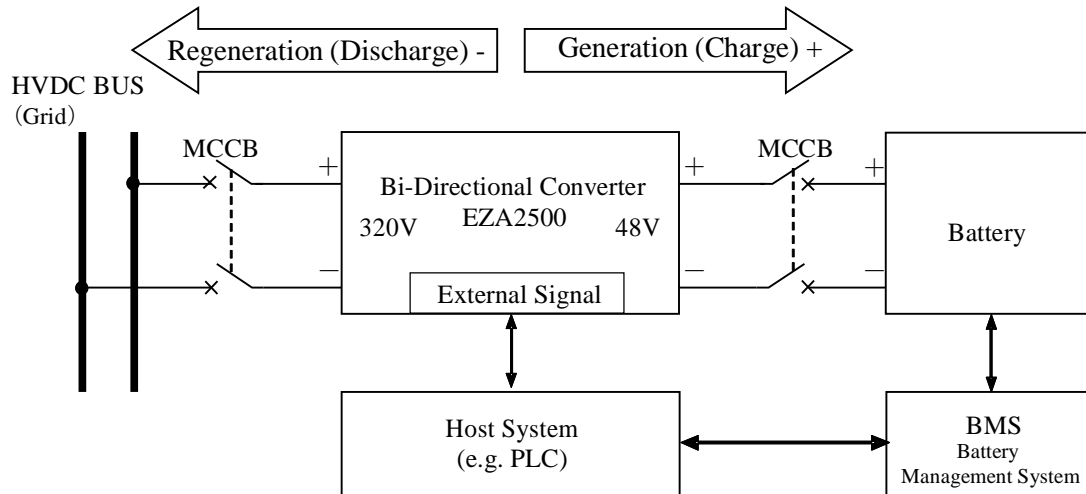

Example of multiple connections

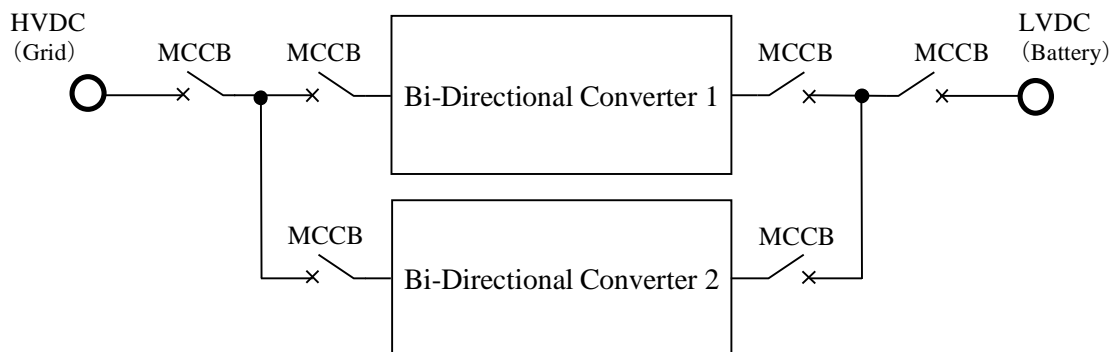

Operation

Generation (Charge) means that power conversion is from HVDC to LVDC.

Regeneration (Discharge) means that power conversion is from LVDC to HVDC.

Current polarity is positive at generation and negative at regeneration.

Note:

Bi-directional converter has a noise filter inside.

However if there is an operation issue due to noise on the DC-bus, please add another noise filter outside of the converter.

2. Part Number Indication

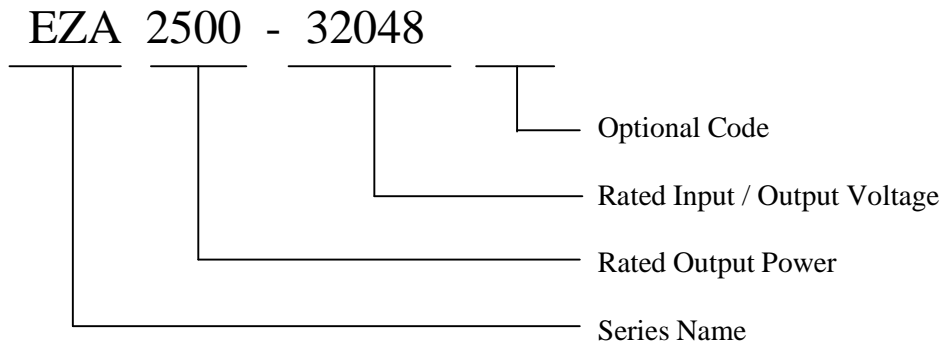

3. Explain of Terminal Connection

Take care of wiring this power supply. Incorrect wiring will damage this product.

3-1. Explanation of Terminal Connection

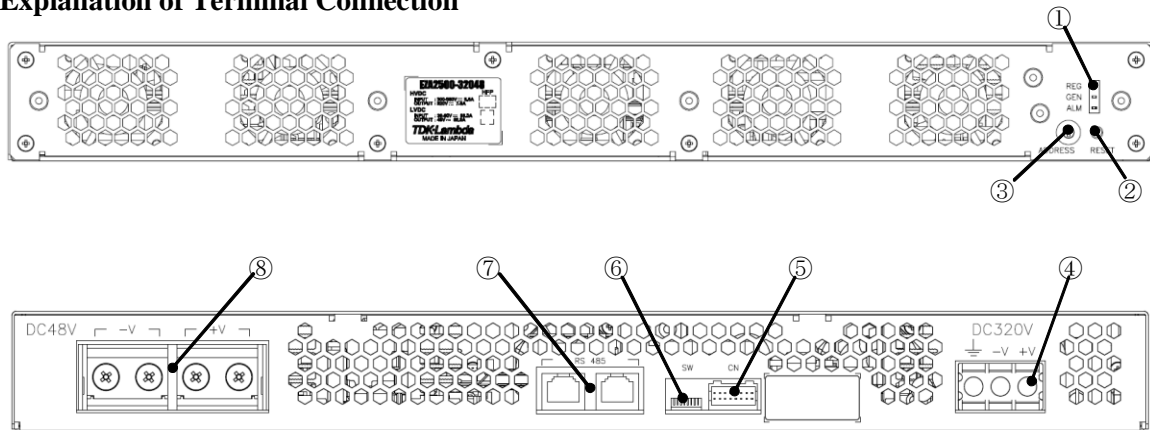

- ① LED of Indicator (Refer to 8.User Interface section)
- ② RESET : Tact Switch (Refer to 8.User Interface section)
- ③ ADDRESS : Rotary Switch (Refer to 8.User Interface section)
- ④ Grid Connection Terminal (DC320V HVDC Terminal : M4 Screw)
 DC Power Supply Input Output Terminal \perp , -V, +V (The fuse is connected to +V)
- ⑤ CN : External Signal Connector (Refer to 9.System Interface section)
- ⑥ SW : DIP Switch (Refer to 8.User Interface section)
- ⑦ RS-485 : Serial Interface Connector (Refer to 9.System Interface section)
- ⑧ Battery Connection Terminal (DC48V LVDC Terminal : M5 Screw)
 DC Power Supply Input Output Terminal -V, -V, +V, +V (The fuse is connected to +V)

3-2. Appropriate Connectors, Housing and Terminal Pins for use in this power supply

Part Name	Model Name	Maker	
CN	Connector (Pin Header)	S16B-PADSS-1	
	Housing (Socket Housing)	PADP-16V-1-S	
	Terminal Pin (Contact)	SPH-002T-P0.5 (AWG28-24)	JST
		SPH-001T-P0.5 (AWG26-22)	
	Crimping Tool	AP-K2N	JST

4. Connection Method

Take care of wiring this power supply. Incorrect wiring will damage this product.

- Be sure that all power lines are disconnected when wiring connections for input, output and connector terminals.
- Route input line and output line separately to avoid noise interference.
- Connect protective earth grounding to the \perp terminal of this power supply.
- Use the recommended connectors described in section “3-2. Appropriate Connectors. Housing and Terminal Pins for use in this power supply”.
- Connector accessories are not included in the delivery package.

5. Block Diagram

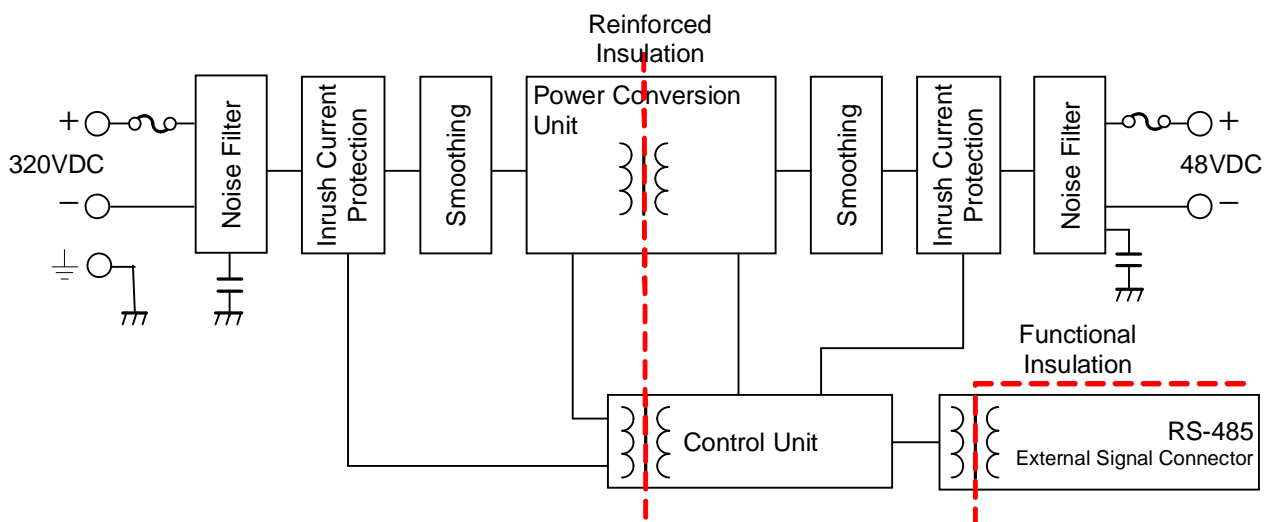

6. Operation Mode

By apply external voltage, HVDC side is more than 250VDC or LVDC side is more than 28VDC the control circuit will be initialized and setting information will be loaded from the non-volatile memory.

At this point each LED will light up and turn off after completing the initialization process.

If the internal interface detects abnormality for some reason, the LED will remain lit up.

After the initialize process, the converter will be in waiting mode. Power conversion operation will start when the operation command is sent.

The internal FANs are rotated during any power conversion operation.

FANs will stop after approximately 3 minutes when operation is stopped by operation command.

With this converter selection of operation mode such as Automatic Battery CV Mode, Automatic Grid CV Mode or Manual CV Mode is possible.

Note that power conversion direction from HVDC (Grid) to LVDC (Battery) will be described as Generation Operation (Charge) and power conversion direction from LVDC (Battery) to HVDC (Grid) will be described as Regeneration Operation (Discharge).

6-1. Automatic Battery CV Mode

Battery voltage is maintained at set target voltage.

If battery voltage is lower than the target voltage :

Generation Operation (Charge)

If battery voltage is higher than the target voltage :

Regeneration Operation (Discharge)

Constant current control is for battery side current both generation operation and regeneration operation.

Battery bus rump up mode can be selected for charged up capacitor of battery side from 0V and/or for operation as bus converter.

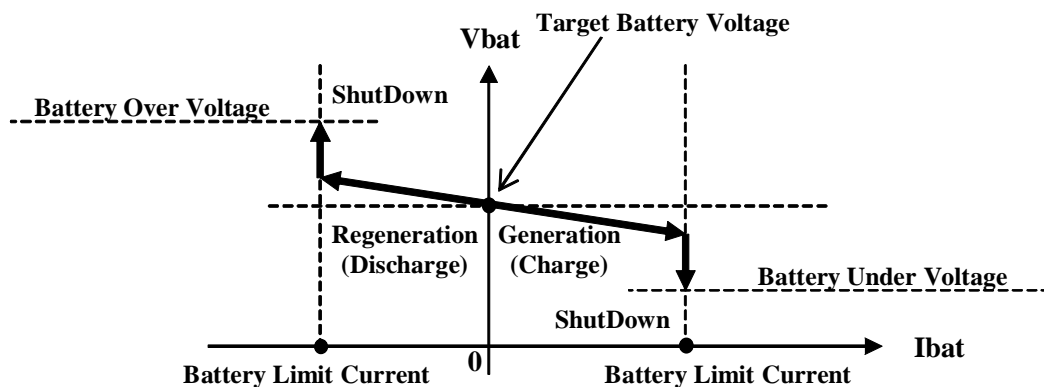
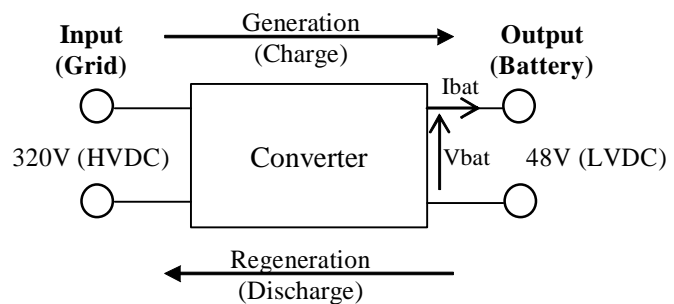

Operating Characteristic

6-2. Automatic Grid CV mode

Grid voltage is maintained at set target voltage.

If grid voltage is lower than the target voltage :
Regeneration Operation (Discharge)

If grid voltage is higher than the target voltage:
Generation Operation (Charge)

There is a dead zone (power conversion non-operational band) which can be set between regeneration voltage level and generation voltage level.

Constant current control is for grid side current both generation operation and regeneration operation.

For generating operation and regenerating operation the target current value can be set separately.

Also, it is possible to set battery over-charge and over-discharge protection that stops charging and discharging process when battery voltage level reaches the target voltage level. (Refer to 7. Battery Protection)

For the Output Side (Grid Port), 300V or more pre-charge is required. When external voltage is not applied, this converter will not operate.

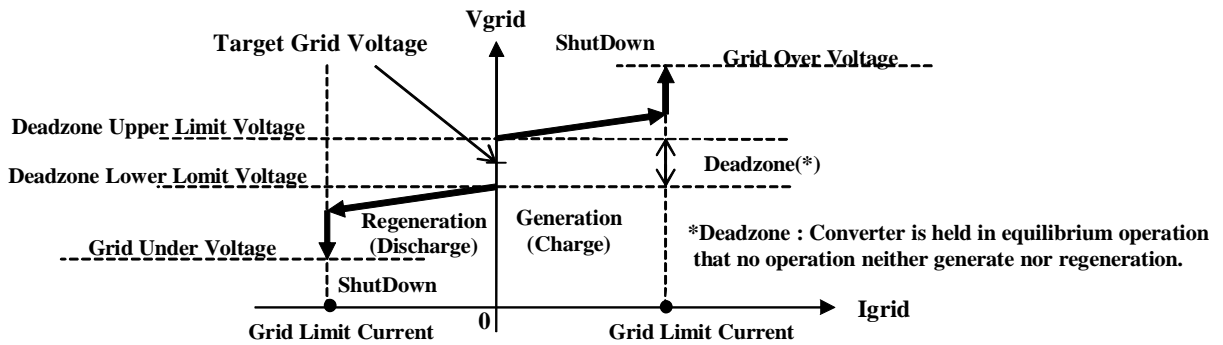
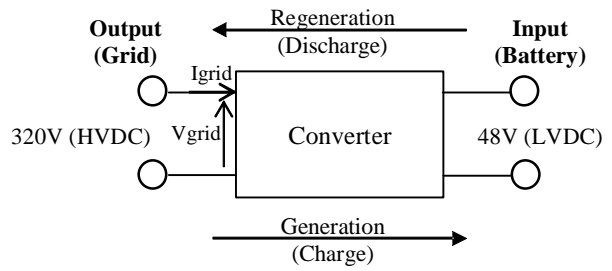

Operating Characteristic

6-3. Automatic Grid CV with Battery CC mode

The basic actions of this mode is same to Grid Automatic CV Mode. Constant current is controlled by battery side current.

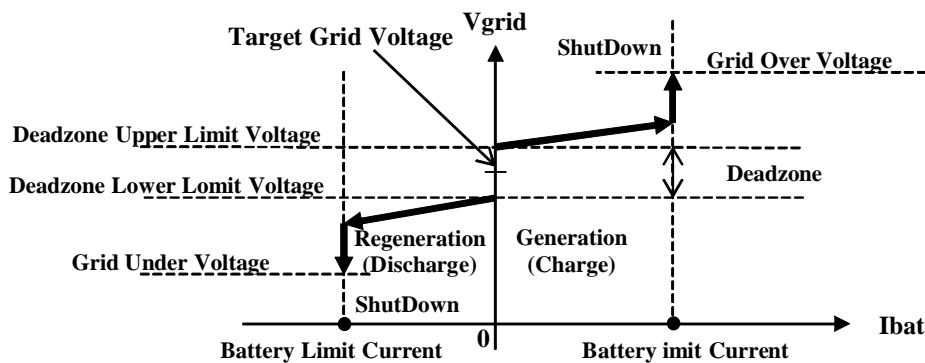
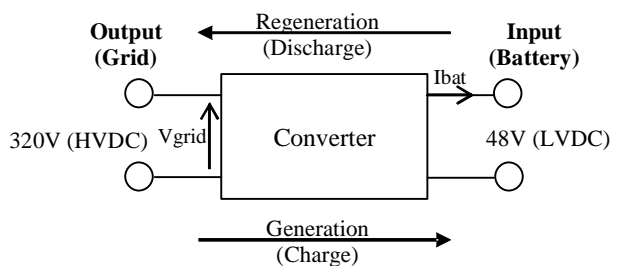

Operating Characteristic

6-4. Manual Battery CV mode

At this mode the converter works only generating operation.

Battery port is controlled by constant voltage or constant current.

Battery bus rump up mode can be selected for charged up capacitor of battery side from 0V and/or for operation as bus converter.

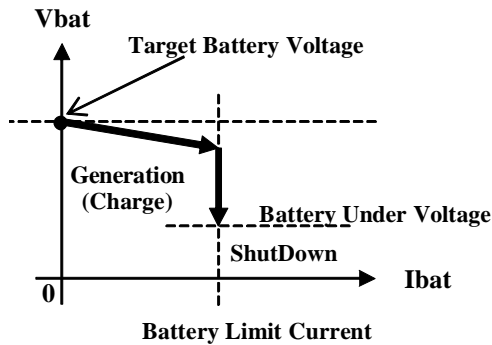

Operating Characteristic

6-5. Manual Grid CV mode

At this mode the converter works only regenerating operation.

Grid port is controlled by constant voltage or constant current.

Also, it is possible to set battery over-charge and over-discharge protection that stops charging and discharging process when battery voltage level reaches the target voltage level. (Refer to 7.Battery Protection)

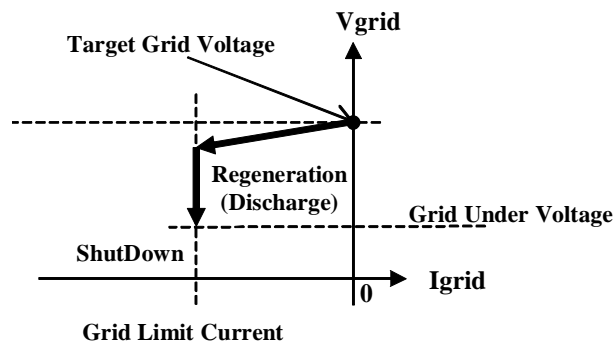

Operating Characteristic

6-6. Manual Grid CV with Battery CC mode

The basic actions of this mode is same to Grid Manual CV Mode.

Constant current is controlled by grid side current.

7. Battery Protection

The converter will restrict the current for avoid the over-charge and over-discharge when battery voltage reach to the setting value if battery protection is enabled (See illustration below).

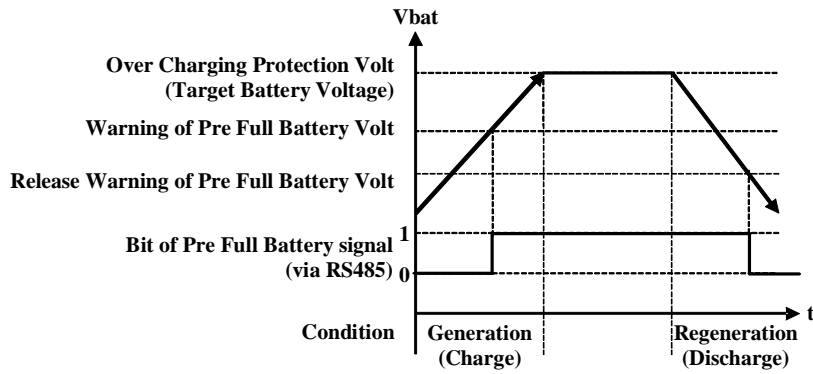

Battery Over Charging Protection Timing Chart

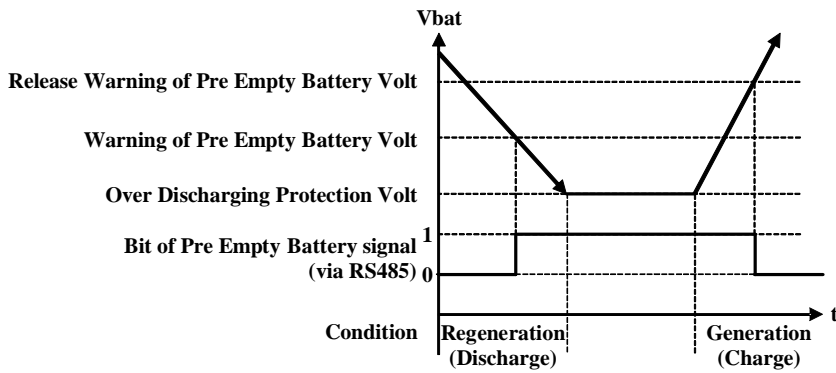

Battery Over Discharging Protection Timing Chart

If the battery internal impedance is large please set the larger release voltage deviation to avoid being affected by the battery internal impedance.

Due to the effect of measurement accuracy, the converter might be charging or discharging with minute current. Please set the over-voltage protection and under-voltage protection to the appropriate values. Also, please use the protective function of battery together.

8. User Interface

The front panel of this converter has a tact switch, rotary switch and 3 LEDs.
Also the rear panel has an 8-bit DIP switch.

8-1. Tact SW

The tact switch functions as alarm clear button when the alarm is activated due to abnormal occurrence.
When this switch is pushed, a command to clear the alarm is sent to the converter while in alarm state (ALM LED ON).
This switch does not function when converter is not alarm state.

8-2. Rotary SW

The rotary switch functions as the RS-485 address setting for this converter.



The interface address is composed of 7 bits and can be set within the range "0x00"~"0x7E" range.
Rotary switch is used to set the lowest digits (last 4 bits) and DIP SW is used to set the highest digits.
Note: The last digit address "F" is a reserved address for broadcast address and must not be used for setting address.

The value pointed by the arrow of the switch is recognized as the lowest digits of the interface address.
"0x00" is default value at the time of factory shipment.

The value of the rotary switch is only recognized at the startup the control circuit in the converter (interface MCU initialization). If the settings are changed during converter operation, the changed setting becomes valid at the start of the next startup the control circuit in this converter.

8-3. DIP SW

DIP Switch functions as a setting switch to designate operating mode of this converter.
DIP switch is turned ON when the lever is pressed down.

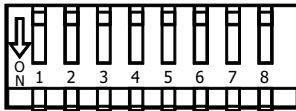

DIP SW			Operating Mode	
1	2	3	With Charging mode	With Discharging mode
OFF	OFF	OFF	Invalid *1	
OFF	OFF	ON	Manual Battery CV	Manual Grid CV
OFF	ON	OFF	Reserved	
OFF	ON	ON	Automatic Battery CV	
ON	OFF	OFF	Manual Battery CV	Automatic Grid CV
ON	OFF	ON	Manual Battery CV	Manual Grid CV with Battery CC
ON	ON	OFF	Manual Battery CV	Automatic Grid CV with Battery CC
ON	ON	ON	Reserved	

DIP SW		RS485 Baud rate *2
4	5	
OFF	OFF	19.2kbps
OFF	ON	38.4kbps
ON	OFF	57.6kbps
ON	ON	9600bps

DIP SW			RS485 Address Area *2
6	7	8	
OFF	OFF	OFF	0 : 0x00 - 0x0E
OFF	OFF	ON	1 : 0x10 - 0x1E
OFF	ON	OFF	2 : 0x20 - 0x2E
OFF	ON	ON	3 : 0x30 - 0x3E
ON	OFF	OFF	4 : 0x40 - 0x4E
ON	OFF	ON	5 : 0x50 - 0x5E
ON	ON	OFF	6 : 0x60 - 0x6E
ON	ON	ON	7 : 0x70 - 0x7E

*1 Operate by RS485 Communication only

*2 The value of the DIP Switch is only recognized at the startup the control circuit in the converter during interface MCU initialization. If the settings are changed during converter operation then the changed settings become valid at the next start up control circuit.

8-4. Operating Status Indicator

The Front Panel of this converter has LEDs (3 pcs) as operating status indicator.

The LED arrangement is shown below together with the conditions when these LEDs light up or turn off.

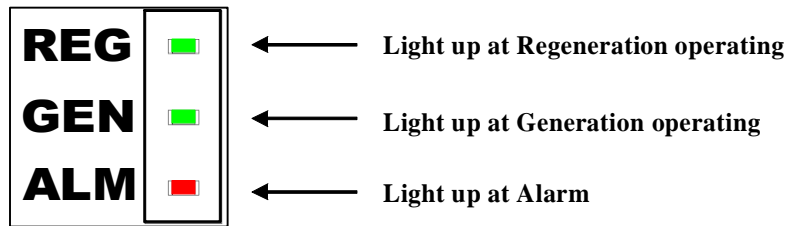

When there is failure inside the converter at all the LEDs light up.
 At no load conditions, REG/GEN LED blinks.

9. System Interface

This converter is provided with one external signal connector and 2 serial interface connectors as an interface to the host devices.

9-1. External Signal Connector (CN)

The external signal connector layout as seen from the rear panel is shown below.

Pin #	Signal	I/O	Note
1	ALM	O	Alarm
2	SG	-	Signal Ground
3	PG	O	Converter Operation Good Signal
4	SG	-	Signal Ground
5	STOP	I	Converter Operation Stop Command
6	SG	-	Signal Ground
7	RUN	I	Converter Operation Start Command
8	SG	-	Signal Ground
9	CHRG	I	Charge, Discharge Conversion Command
10	SG	-	Signal Ground
11	ALMCLR	I	Alarm Clear
12	SG	-	Signal Ground
13	-	-	Reserved
14	SG	-	Signal Ground
15	AUX5V	O	Service Power Supply
16	SG	-	Signal Ground

Pin #13 is reserved, do not connect.

9-1-1. Alarm Signal, ALM

Alarm Signal ALM is outputted (Pin 1 becomes open) when Alarm occurs. (Synchronized with Alarm Indicator LED)

9-1-2. Converter Good Operation Signal, PG

Converter Good Operation Signal PG is outputted (Pin 3 becomes short to SG) during Converter Operation (Power Conversion).

9-1-3. Converter Operation Stop Command, STOP

By shorting this signal to SG, the converter can be forcibly stopped.
 (STOP prioritizes interface command)

This signal is categorized as a heavy alarm. When this command is detected the Alarm Signal "ALM" is outputted.

9-1-4. Converter Operation Start Command, RUN

By shorting this signal to SG, the converter will commence power conversion according to the pre-set DIP Switch Operation Mode.

9-1-5. Charge/Discharge Conversion Command, CHRГ

Charge/Discharge Conversion Command, CHRГ (Pin 9) is used for operation mode change.

The converter change to the Charging mode when this signal is open.

The converter change to the Discharging mode when this signal short to SG.

There is behavior differs on operating mode and DIP switch setting. Please refer to “8-3. DIP SW”.

9-1-6. Alarm Clear Command, ALM CLR

During converter stoppage due to alarm, the latched alarm of this converter can be reset by Alarm Clear Command ALMCLR (Pin 11) short to SG, then open again.

9-1-7. Service Power Supply, AUX 5V

Service Power Supply (Pin 15) is referenced to SG with approximately 4.7V.

A maximum of 20mA DC load can be connected. Current limit should be provided externally outside the converter.

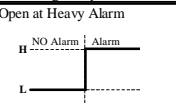
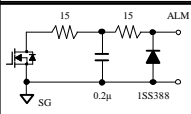
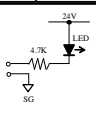
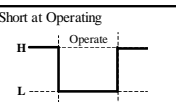
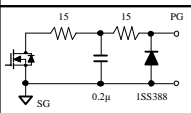
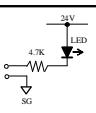
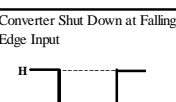
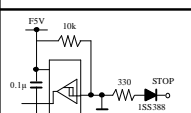
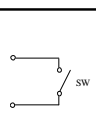
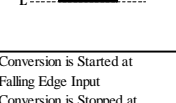
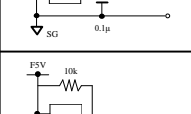
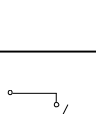
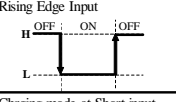
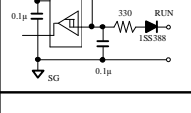
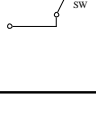
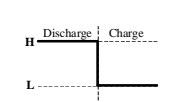
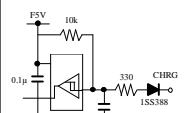
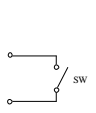
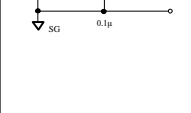
PIN #	I/O	Signal	Signal Operation	Response time	Internal Circuit	External Condition	Example Circuit	Note
1	O	ALM	Open at Heavy Alarm 	-		Extra Circuit Voltage: 5V~30V (max 20mA)		Open Drain Output. Current Limitation should be limited by External Circuit. Pin #1 becomes open when heavy alarm occurs.
3	O	PG	Short at Operating 	-		Extra Circuit Voltage: 5V~30V (max 20mA)		Open Drain Output. Current Limitation should be limited by External Circuit. Pin #3 becomes short to SG when converter operating.
5	I	STOP	Converter Shut Down at Falling Edge Input 	2ms(typ.) +Chattering removal time (16ms)		No Voltage Contact Input		When use semiconductor SW, ON voltage should be 0.3V maximum. Converter can be forcibly stopped by pin #5 short to SG. Converter shuts down by falling edge of input signal and is hold if input signal released.
7	I	RUN	Conversion is Started at Falling Edge Input Conversion is Stopped at Rising Edge Input 	10ms(typ.) 30ms(max) +Chattering removal time (60ms)		No Voltage Contact Input		When use semiconductor SW, ON voltage should be 0.3V maximum. Converter starts operate by pin #7 short to SG. Converter will be started operate by falling edge of signal and keep operate under low level signal Converter will be stopped by rising edge of input signal released.
9	I	CHRG	Charging mode at Short input 	10ms(typ.) 30ms(max) +Chattering removal time (60ms)		No Voltage Contact Input		When use semiconductor SW, ON voltage should be 0.3V maximum. This signal used in combination with RUN signal. At Manual CV Mode Power conversion is between Generation and Regeneration. Generate operation when pin#9 short to SG. Regeneration mode when pin#9 open. At Automatic Grid CV Mode Power conversion is between Manual Grid Mode and Automatic Grid Mode. Manual Grid Mode when pin#9 short to SG. Automatic Grid Mode when pin#9 open. This command does not function at Automatic Battery Mode.
11	I	ALMCLR	Alarm Clear at Falling Edge 	10ms(typ.) 30ms(max) +Chattering removal time (60ms)		No Voltage Contact Input		When use semiconductor SW, ON voltage should be 0.3V maximum. During converter stopped due to ALM, converter can be restart by ALMCLR. Become alarm clear by pin #11 short to SG, then open again.
13	I	Reserved	-	-	-	No Voltage Contact Input	-	Reserved. Do not connect.
15	-	AUX5V	-	-		-	-	Current limitation should be limited by External Circuit.

*SG(Signal Ground) is functional insulation from converter ground.

9-2. Serial Interface Connector

This converter uses RS-485 as serial interface to the host devices.
The connector type uses the same RJ-45 (shielded) as the general-purpose LAN cables.
The interface connector layout as seen from the rear panel is shown below.

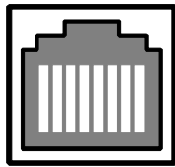

87654321

Pin #	Signal	Note
1	NC	No use
2	NC	No use
3	NC	No use
4	D1	B (Inverted diffirential pair)
5	D0	A (Non-inverted diffirential pair)
6	NC	No use
7	NC	No use
8	Common	Common return

It is also possible to use LAN STP cables as connecting cables.
Setting value is stored in the internal memory.
For detail of communication, please refer to "Communication manual".

9-3. Serial Connection of Multiple Converters

In order to facilitate RS-485 connection, this converter is provided with 2 serial interface connectors.
The interface circuit of this converter functions as intermediate RS-485 connectors.
Due to this feature RS-485 bus can be extended simply by connecting interface cables between converters when connecting multiple converters to the host devices. (Depending on surrounding environment, there might be a need to use a termination to connect to one converter or both the converter and the host devices.)

Shown below is an example of serial connection of 4 converters.

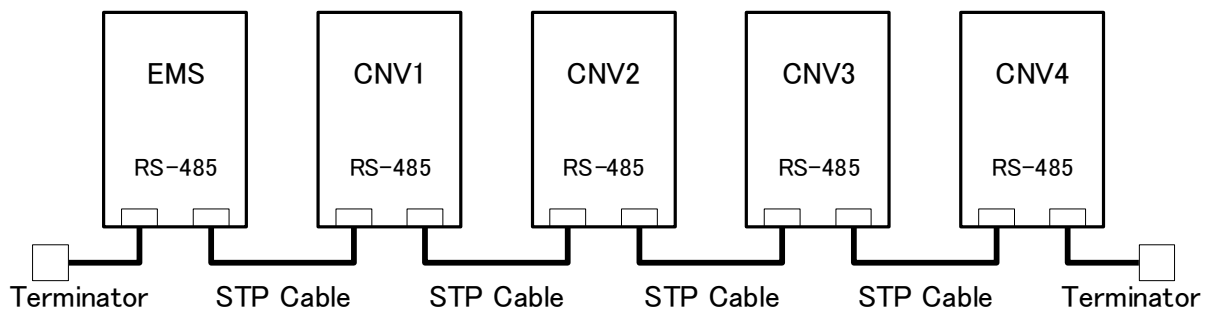

The address of converters connected to RS-485 bus including host devices should be unique.
Each unique address can be set by Rotary Switch and DIP Switch.
Possible address setting ranges are "0x00"~"0x7E".

9-4. Broadcast Address

Interface Address "0xFF" and Interface "0xkF"(k : 0~7) are special addresses and functions as broadcast address. When "0xFF" is set as receiving address in command sent by Host, all the converters connected within the interface bus receives that command.

When the lowest digit of the address is set to "F", all the converters within the same group receives that command. Please note that all commands sent to the Broadcast Address cannot make the response message.

Below is an example of converter address and their corresponding Broadcast Address.

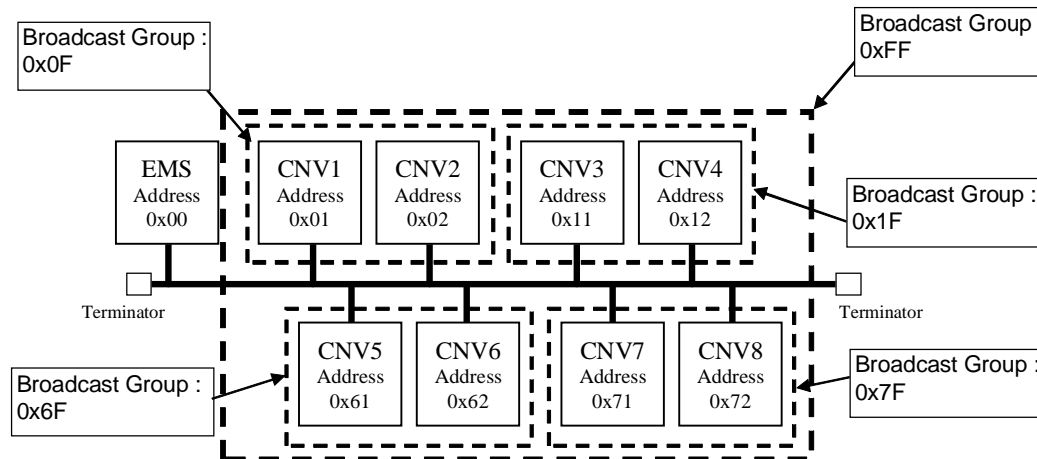

*For details regarding Serial Interface, please refer to "Communication Manual"

10. Alarm

10-1 Types of Alarm

Alarm category	Alarm Rest	Operating Detail
Heavy Alarm	Can be Reset	Converter Stopped, Alarm Signal triggered ON, PG Open;
		Can be reset to former status by Alarm Clear Command
Heavy Alarm (System Alert)	Cannot be Reset	Converter Stopped, Alarm Signal triggered ON, PG Open;
		Cannot be reset by Alarm Clear Command
Light Alarm	Can be Reset	Converter Stopped, PG Open;
		Can be reset to former status by clearing the alarm

Alarm status can be verified by RS-485 interface.

10-1-1. Heavy Alarm

When Heavy Alarm is detected, External signal connector ALM signal is triggered (open).

When this happens during power conversion process, power conversion stops and the external signal connector PG becomes open. Heavy Alarm can be reset by alarm clear command (Interface, External Signal Connector ALMCLR or pushing Tact Switch RESET). After resetting the alarm, power conversion will commence again.

10-1-2. Heavy Alarm (System Alert)

When Heavy Alarm (System Alert) is detected, external signal connector ALM signal is triggered (open). When this happens during power conversion process, power conversion stops and the external signal connector PG becomes open. Heavy Alarm (System Alert) cannot be reset by alarm clear command. Heavy Alarm (System Alert) can be reset by power down and power on again. Depending on the cause Heavy Alarm (System Alert) might re-occur.

10-1-3. Light Alarm

If a light alarm occurred during power conversion operation then power conversion operation will stop and the external signal connector PG will open. Light alarm indicates that power conversion cannot be executed due to external abnormalities. Power conversion will commence once the external abnormalities are removed and the converter operation mode command is valid.

10-2. Alarm Category and their Details

Alert Item	Operating Mode	Waiting	Manual Mode		Automatic Mode	
			Battery	Grid	Battery	Grid
Battery Over Voltage		Light Alarm	Heavy Alarm	Light Alarm	Heavy Alarm	Light Alarm
Battery Under Voltage		Light Alarm	Heavy Alarm	Heavy Alarm	Heavy Alarm	Heavy Alarm
Battery Over Current		Heavy Alarm	Heavy Alarm	Heavy Alarm	Heavy Alarm	Heavy Alarm
Grid Over Voltage		Light Alarm	Light Alarm	Heavy Alarm	Heavy Alarm	Heavy Alarm
Grid Under Voltage		Light Alarm	Light Alarm	Heavy Alarm	Heavy Alarm	Heavy Alarm
Grid Over Current		Heavy Alarm	Heavy Alarm	Heavy Alarm	Heavy Alarm	Heavy Alarm
Hardware Over Current		-	Heavy Alarm	Heavy Alarm	Heavy Alarm	Heavy Alarm
Converter Stop Command(External Signal)		Heavy Alarm	Heavy Alarm	Heavy Alarm	Heavy Alarm	Heavy Alarm
Fan Lock		-	Heavy Alarm	Heavy Alarm	Heavy Alarm	Heavy Alarm
Abnormal Temperature of Heatsink(Primary)		Heavy Alarm	Heavy Alarm	Heavy Alarm	Heavy Alarm	Heavy Alarm
Abnormal Temperature of Heatsink(Secondary)		Heavy Alarm	Heavy Alarm	Heavy Alarm	Heavy Alarm	Heavy Alarm
Abnormal Temperature of Converter		Light Alarm	Light Alarm	Light Alarm	Heavy Alarm	Light Alarm
System Alert		Heavy Alarm	Heavy Alarm	Heavy Alarm	Heavy Alarm	Heavy Alarm

Alarm Category

Threshold Values that are adjustable can be set by RS-485 interface.

10-2-1. Battery Over Voltage

When the measured battery voltage goes up threshold level, the battery over voltage alarm is triggered.
 Threshold level can be adjusted.

10-2-2. Battery Under Voltage

When the measured battery voltage goes down threshold level, the battery under voltage alarm is triggered.
 Threshold level can be adjusted.

10-2-3. Battery Over Current

When the measured battery current goes up threshold level, the battery over current alarm is triggered.
 Threshold level is fixed.

10-2-4. Grid Over Voltage

When the measured grid voltage goes up threshold level, the grid over voltage alarm is triggered.
 Threshold level can be adjusted.

10-2-5. Grid Under Voltage

When the measured grid voltage goes down threshold level, the grid under voltage alarm is triggered.
 Threshold level can be adjusted.

10-2-6. Grid Over Current

When the measured grid current goes up threshold level, the grid over current alarm is triggered.
 Threshold level is fixed.

10-2-7. Hardware Over Current

When the over current circuit comparator detects current over the threshold level, the Hardware Over Current Alarm is triggered. Threshold level is fixed.

10-2-8. Converter Stop Command(External Signal)

When Converter Stop Command of the External Signal Connector is detected, the Converter Stop Alarm is triggered.

10-2-9. Fan Lock

If internal FAN rotation speed reduces too far: the FAN Lock Alarm is triggered.
 Threshold level is fixed.

10-2-10. Abnormal Temperature of Heatsink(Primary)

Abnormal temperature at Heatsink (Primary) detection is done through thermistor its detection temperature is about 100 degree C. Signal from the Abnormal detect circuit triggers Abnormal Temperature at Heatsink (Primary). Detect threshold level is fixed.

10-2-11. Abnormal Temperature of Heatsink(Secondary)

Abnormal temperature at Heatsink (Secondary) detection is done through thermistor its detection temperature is about 100 degree C. Signal from the Abnormal detect circuit triggers Abnormal Temperature at Heatsink (Secondary). Detect threshold level is fixed.

10-2-12. Abnormal Temperature of Converter

When converter internal measured temperature exceeds detect threshold level (about more than 53 degree C) Abnormal Temperature of Converter Alarm is triggered. Detect threshold level is fixed.

10-2-13. System Alert

When Abnormality is detected in this converter, System Alarm will be triggered. Alarm due to System Alert is not covered by Alarm Recovery procedures.

11. Explanation of Functions and Precautions

11-1. Input Voltage Range

Input voltage range is 36 – 60VDC for LVDC, and 300 – 380VDC for HVDC.
Input voltage which is out of specification might cause unit damage.

11-2. Output Voltage Range

Output voltage setting range is 36 – 60VDC for HVDC and 300 – 380VDC for LVDC.
Set output voltage is via RS-485 communication.

11-3. Constant Current Range

Constant current setting range is 2.4 – 56A for HVDC and 0.5 – 8.5A for LVDC.
Set constant current is via RS-485 communication.

Attention:

If you want to operate constant current at Regeneration (discharge) mode then set grid under voltage level is in the HVDC voltage vs LVDC voltage derating curve area.

During operation outside of derating curve the converter cannot operate constant current operation and output current increases.

In this case the converter will be shut down when the output current is more than 8.7A and the input power of battery side is more than 2750W.

Example:

Case of regeneration constant current mode operation at 380VDC of output voltage (Grid side) and 60VDC of input voltage (Battery side), set Grid under voltage level is more than 350VDC.

11-4. Output Ripple & Noise

The specification for maximum ripple value is measured according to specified measurement circuit, using Ripple Meter RM-103 made in Keisoku giken (co.Ltd).

When a distance of Load line becomes long, the ripple noise can be reduced by attach the Electrolytic capacitors, film capacitors, etc to the load terminals.

11-5. Series Operation

Series operation is not possible.

11-6. Parallel Operation

Parallel operation to increase the output current is possible.

Converter has droop function for current share.

Droop ratio can be set via RS-485.

Voltage drop will increase with a large current droop ratio which makes it easier to balance.

Please follow below indications:

- 1) Please set same output voltage.
- 2) Please use same size and same length of output wires.
- 3) Please use same size and same length of input wire for each separate converter.

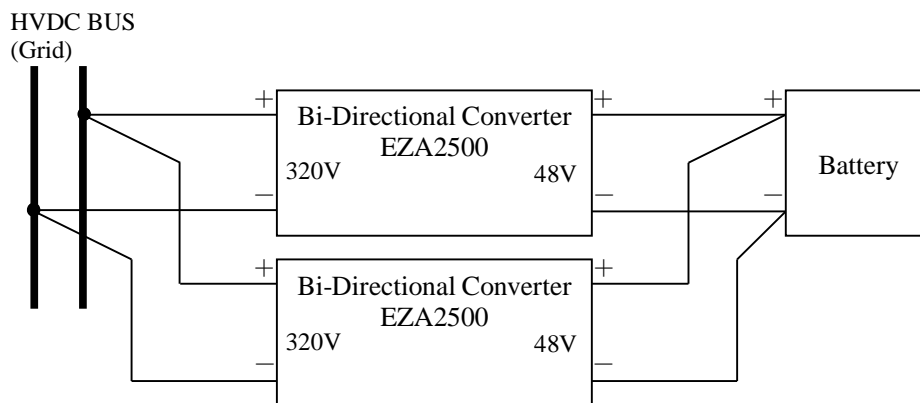

11-7. Dynamic Loads

At full load or no-load conditions and during transients and dynamic changes of output voltage, over-voltage protection and under-voltage protection might work. So, please pay attention.

11-8. Isolation Test

Isolation Resistance between secondary (DC48V) & signals and chassis (\perp) is more than 100M Ω at 500VDC. The voltage setting of isolation tester to the test voltage should be made and verified before the test is performed higher voltages than recommended could damage the unit.

Ensure that the unit is fully discharged after the test.

- Secondary (DC48V) & signals and chassis (\perp) : more than 100M Ω at 500VDC
- *All pins of RS-485 and CN connectors must be shorted.

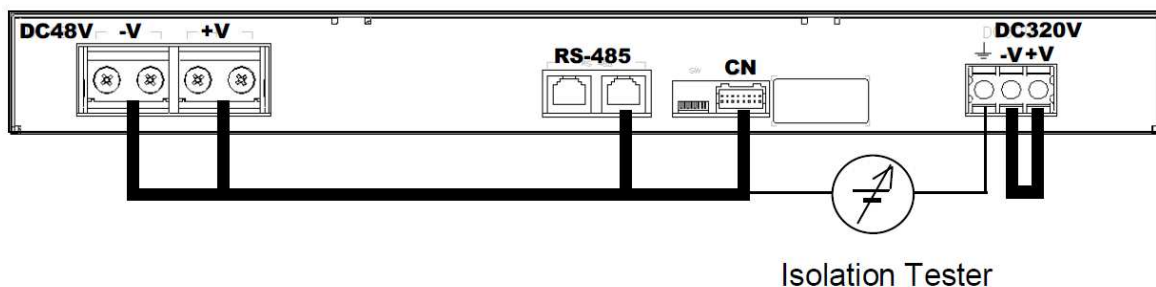

11-9. Withstand Voltage Test

This converter is designed to withstand 3kVAC between primary (DC320V) and secondary (DC48V) & signals, 2kVAC between primary (DC320V) and chassis (\perp),

707VDC between secondary (DC48V) & signals and chassis (\perp) each for 1minute.

When testing withstand voltage set current trip limit of withstand voltage test equipment to 20mA.

The applied voltage must be gradually increased from zero to testing value and then gradually decreased to zero.

When timer is used the unit may be damaged by high rate of change of voltage at turn on/off. Ramp the voltage even if using a timer.

Connect +V and -V as follows.

- Primary (DC320V) - Secondary (DC48V) & Signals 3kVAC, 1min. (20mA)

*Must connect short all pins of RS-485 and CN.

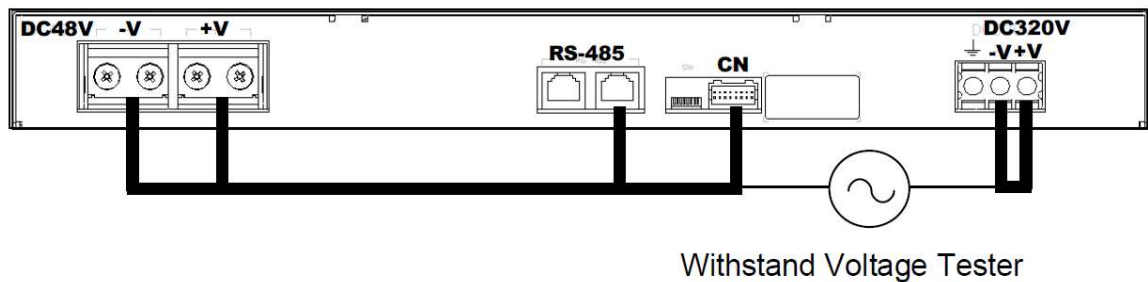

- primary (DC320V) and chassis(\perp): 2000VAC, 1min(50mA)

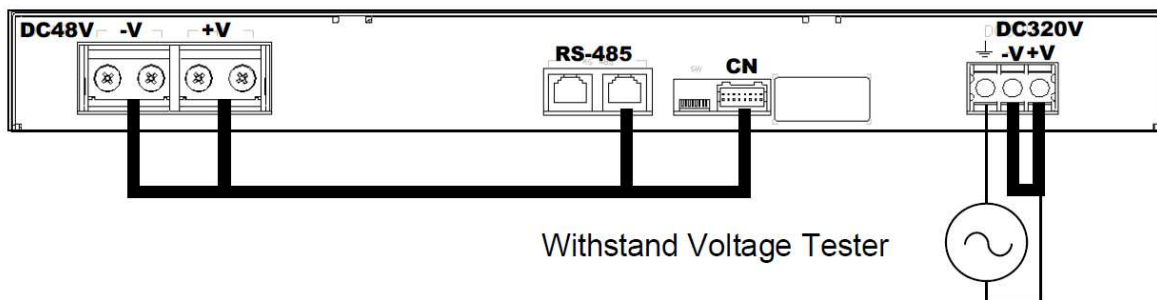

- Secondary (DC48V) & Signals - Chassis (\perp): 707VDC 1min.

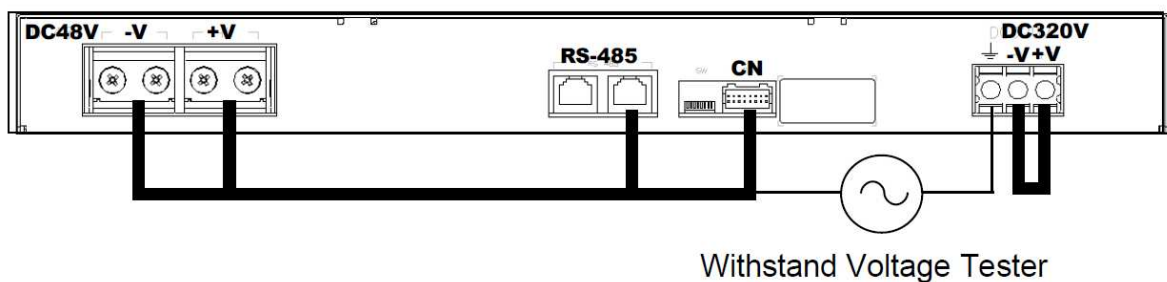

Notes: This product has ceramic capacitor between secondary circuit and chassis. Some withstand voltage tester can generate higher voltage then the capacitor can withstand – so be careful to set the test voltages as above and no higher – otherwise capacitors may be damaged.

12. Mounting

Please install reliably using M4 tap 8 places of the bottom of chassis (see below circle).
The maximum allowable penetration of mounting screws is 6mm.

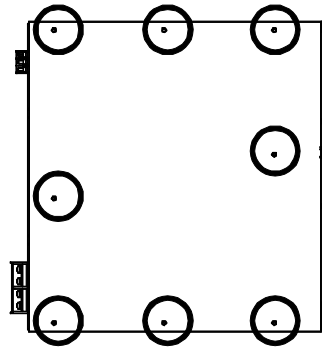

Converter Bottom View

12-1. Mounting Direction

Recommended standard mounting method (A).

(A) Standard Mounting

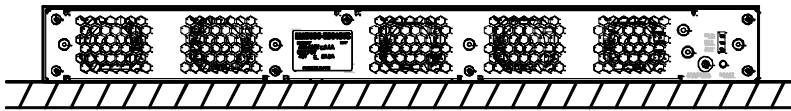

(B) Not possible

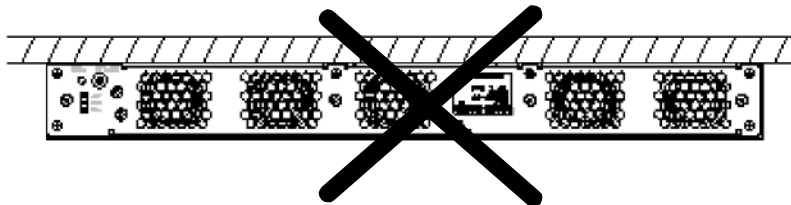

12-2. Mounting Method

- (1) Forced air cooling type converter.
This converter has ventilating holes on the front and rear side panel.
Keep these two areas freely as much as possible.
- (2) The maximum allowable penetration of mounting screws is 6mm.
Incomplete thread of mounting screw should not be penetrated.
- (3) Recommended torque for mounting screw
M4 screw : 1.27 N·m (13.0kgf·cm)

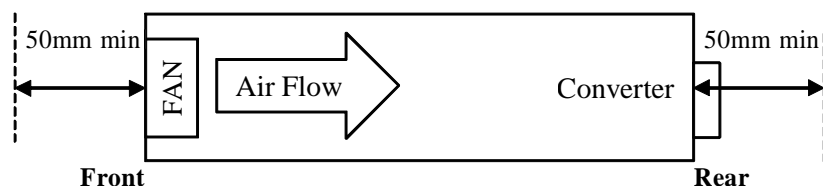

13. Output Derating

13-1. LVDC Voltage vs LVDC Current Derating

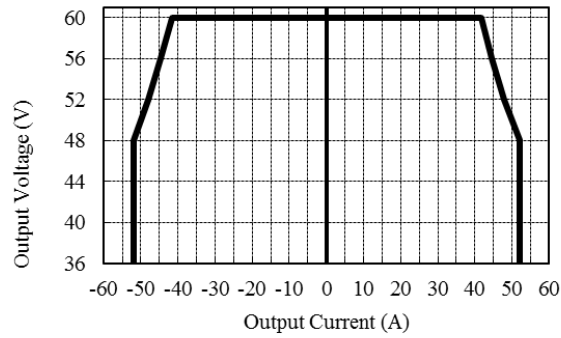

13-2. HVDC Voltage vs HVDC Current Derating

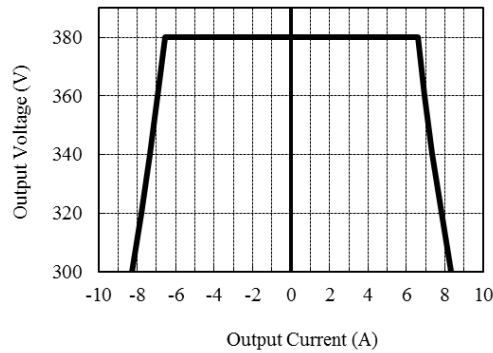

13-3. HVDC Voltage vs LVDC Voltage Derating

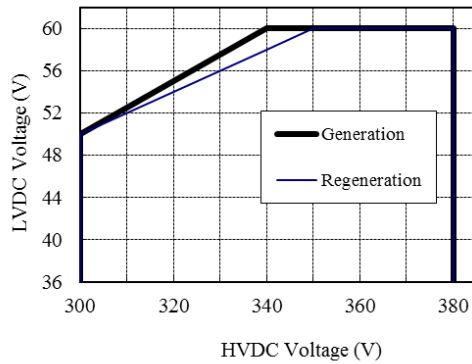

13-4. Ambient Temperature vs Output Derating

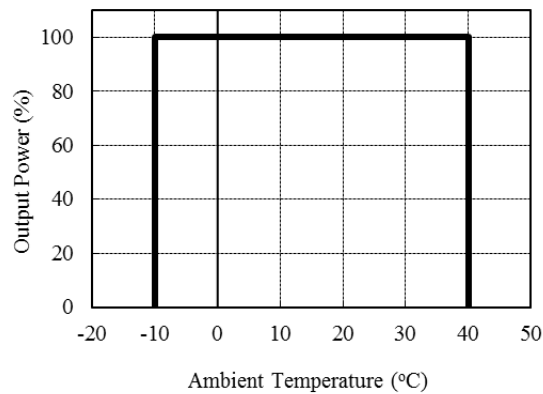

14. Wiring Method

- (1)The output load line and input line should be separated.
- (2)Use all lines as thick and short as possible to make lower impedance. The lines shall be twisted or use shielded wire to improve noise sensitivity.
- (3)Noise can be reduced by attaching a capacitor to the load terminals.
- (4) For safety and EMI considerations connect \equiv terminal to the mounting set ground terminal by thick wire
- (5)If lightning surge protection is required, please place it in front of the converter. There is no protection against lightning surge inside the converter.

14-1. Inserting contact into housing

- (1)Do not apply any pulling force to crimped part and insert contact straightly to housing.
- (2)Insert contact into housing, without stopping, to its furthest extent.
- (3)Check secure locking on each insertion by pulling wire softly in order to check that contact does not come off housing. Besides, check whether there is the backlash in the direction of insertion axis.

14-2. Mating and Un-mating connector

Hold receptacle housing securely and insert into header straight against to headed post until click sounds. Hold all wire securely and fix receptacle housing by fingers so as to unplug and then withdraw it on the mating axis.

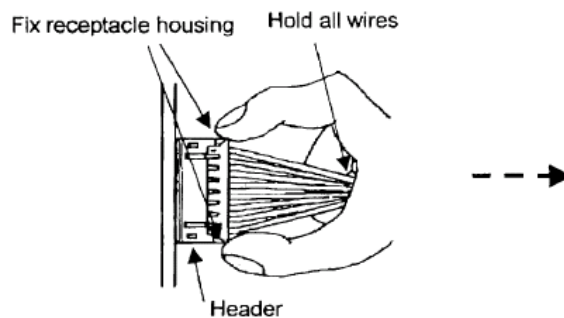

14-3. Routing of Wire

Routing wire so as not to apply external force to connector except force such as extent that bend the wire slightly, considering an enough length to route and fixing of wire.

15. External Fuse Rating

Refer to following fuse rating when selecting external fuses that are to be used on input line.

Surge current flows when line turn on.

Do not select the fuse with input current values under the actual load condition.

HVDC (DC320V): 20A Fast Blow type

LVDC (DC48V): 125A Fast Blow type

16. Fan Life Expectancy

The Fan-life expectancy is about 6.5 years at 40 degree C intake-air temperature.

Therefore, periodic maintenance by exchanging the life-expired fan is required for the converter.

Fan replacement service will be a charge, please contact your local TDK-Lambda sales office.

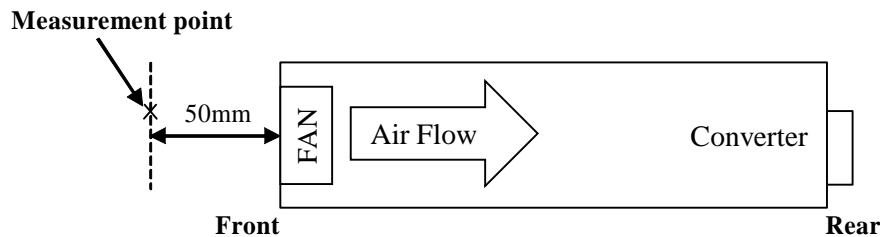

17. Before concluding that the unit is fault

- (1) Check if the rated input voltage connected.
- (2) Check if the wiring of input and output is correct.
- (3) Check if the wire thickness is enough.
- (4) Check if the built-in FAN is not stopped. Is FAN stopped by something irregular? If FAN stops, heavy alarm is triggered.
- (5) The converter has ventilating holes on the front and rear panels. Check if there is any irregulars or dust, etc.
- (6) Is this chassis of converter abnormally hot? The output might shut down by OTP operation. Please re-start after allowing time for the unit to cool down sufficiently.
- (7) Check if the output current and output wattage does not over specifications.
- (8) Audible noise can be heard during dynamic load operation.

18. Range of free warranty

This product warranted for a period of 5 years from the date of shipment. For a breakdown under a normal use during free warranty term repair is a free of charge. However replacement of the built-in fan is chargeable. Please contact your local TDK-Lambda sales office for FAN replacement.

The following cases are not covered by warranty:

- (1) Improper usage like dropping products, applying shock and defects from operation exceeding specification of the unit.
- (2) Defects resulting from natural disaster (fire, flood).
- (3) Unauthorized modifications or repair by the user, defects not cause by TDK-Lambda.