

DPX60-xxSxx Single Output: DC-DC Converter Module

18 ~ 36 VDC and 36~ 75 VDC input; 3.3 to 24 VDC Single Output;
60 Watts Output Power



CE MARKED

SAFETY MEETS: UL60950-1
EN60950-1
IEC60950-1

FEATURES

- NO MINIMUM LOAD REQUIRED
- HIGH EFFICIENCY UP TO 89%
- INPUT TO OUTPUT ISOLATION : 1600VDC
- SCREW TERMINALS FOR INPUT AND OUTPUT CONNECTIONS
- RELIABLE SNAP-ON FOR DIN RAIL TS-35/7.5 OR TS-35/15
- CASE PROTECTION MEETS IP20(IEC60529)
- INPUT FUSE PROTECTION
- INPUT REVERSE POLARITY PROTECTION
- INPUT IN-RUSH CURRENT LIMIT CIRCUIT
- OUTPUT DC-OK INDICATOR
- 2:1 WIDE INPUT VOLTAGE RANGE
- FIXED SWITCHING FREQUENCY
- INPUT UNDER-VOLTAGE PROTECTION
- OUTPUT OVER-VOLTAGE PROTECTION
- OVER-CURRENT PROTECTION
- OUTPUT SHORT CIRCUIT PROTECTION
- REMOTE ON/OFF
- COMPLIANT TO RoHS II & REACH

APPLICATIONS

- COMMUNICATION SYSTEMS
- INDUSTRY CONTROL SYSTEMS
- FACTORY AUTOMATIC EQUIPMENT
- SEMICONDUCTOR EQUIPMENT

OPTIONS

- REMOTE ON/OFF

GENERAL DESCRIPTION

The DPX60-xxSxx series was designed for applications requiring din rail mountable DC-DC converters. Easy installation is provided with snap-on mounting to the DIN-rail. Internal circuits provide protection against reverse input voltage, input in-rush current, output short-circuit, output over-current, and output over-voltage conditions. A green LED at the front panel indicates the status of the output voltage.

Contents

Output Specifications	3
Input Specifications	4
General Specifications	5
Environmental Specifications	5
EMC Characteristics	5
Characteristic Curves	
DPX60-24S3P3	6
DPX60-24S05	8
DPX60-24S12	10
DPX60-24S15	12
DPX60-24S24	14
DPX60-48S3P3	16
DPX60-48S05	18
DPX60-48S12	20
DPX60-48S15	22
DPX60-48S24	24
Input Source Impedance	26
Output Over Current Protection	26
Output Short Circuit Protection	26
Output Over Voltage Protection	26
Remote On/off Control	27
EMS Considerations	28
Mechanical Data	28
Packaging Information	28
Part Number Structure	29
MTBF and Reliability	29

Output Specifications

Parameter	Model	Min	Typ	Max	Unit
Output Voltage (Vin(nom); Full Load; Ta=25°C)	xxS3P3	3.251	3.3	3.349	VDC
	xxS05	4.95	5	5.05	
	xxS12	11.88	12	12.12	
	xxS15	14.85	15	15.15	
	xxS24	23.76	24	24.24	
Output Regulation Line (Vin(min) to Vin(max); Full Load) Load (0% to 100% of Full Load)	All	-0.5		+0.5	%
	xxS3P3	-2.5		+2.5	
	Others	-1.5		+1.5	
Output Ripple and Noise Peak to Peak (20MHz Bandwidth)	xxS3P3		75	100	mVp-p
	xxS05		75	100	
	xxS12		100	125	
	xxS15		100	125	
	xxS24		130	180	
Voltage Adjustability	xxS24	-10		+20	% of Vout
	Others	-10		+10	
Temperature Coefficient	All	-0.02		+0.02	%/°C
Output Voltage Overshoot (Vin(min) to Vin(max); Full Load; Ta=25°C)	All			5	% of Vout
Dynamic Load Response (Vin(nom); Ta=25°C) Load step change from 75% to 100% or 100 to 75% of Full Load Peak Deviation	xxS24		720		mV
	Others		200		mV
	All		250		µs
	Settling Time (Vo < 10% peak deviation)				
Output Current	xxS3P3	0		14	A
	xxS05	0		12	
	xxS12	0		5	
	xxS15	0		4	
	xxS24	0		2.5	
Output Capacitance Load	xxS3P3			36000	µF
	xxS05			20400	
	xxS12			3550	
	xxS15			2300	
	xxS24			885	
Output Over Voltage Protection (see page 26) (Zener diode clamp)	xxS3P3	3.7		5.4	VDC
	xxS05	5.6		7.0	
	xxS12	13.8		17.5	
	xxS15	16.8		20.5	
	xxS24	30.0		33.0	
Output Indicator		Green LED			
Output Over Current Protection (see page 26) (% of Iout rated; Hiccup mode)	All			150	% of FL
Output Short Circuit Protection (see page 26)	All	Continuous, automatic recovery			

Input Specifications

Parameter	Model	Min	Typ	Max	Unit
Operating Input Voltage					
Continuous	24Sxx 48Sxx	18 36	24 48	36 75	VDC
Transient (100ms,max)	24Sxx 48Sxx			50 100	
Input Standby Current (Vin(nom); No Load)	24S3P3 24S05 24S12 24S15 24S24 48S3P3 48S05 48S12 48S15 48S24		104 134 59 74 76 102 94 37 42 45		mA
Under Voltage Lockout Turn-on Threshold	24Sxx 48Sxx			17.5 34.5	VDC
Under Voltage Lockout Turn-off Threshold	24Sxx 48Sxx		15 32		VDC
Input Reflected Ripple Current (see page 26) (Vin(nom); Full Load)	All		15		mAp-p
Start Up Time (Vin(nom) and constant resistive load) Power up Remote ON/OFF	All		100 20		ms
Remote ON/OFF Control (see page 27) (The Ctrl pin voltage is referenced to negative input) Positive Logic (Optional) On/Off pin High Voltage (Remote ON) On/Off pin Low Voltage (Remote OFF) Negative Logic (Optional) On/Off pin Low Voltage (Remote ON) On/Off pin High Voltage (Remote OFF)	xxSxx-P xxSxx-N			Open or 3 ~ 12VDC Short or 0 ~ 1.2VDC Short or 0 ~ 1.2VDC Open or 3 ~ 12VDC	
Input Current of Remote Control Pin		-0.5		1.0	mA
Remote Off State Input Current			4		mA
Input Fuse (Slow Blow)	24Sxx 48Sxx		8 4		A
In-rush Current			15		A

General Specifications

Parameter	Model	Min	Typ	Max	Unit
Efficiency (Vin(nom); Full Load; Ta=25°C)	24S3P3		87		%
	24S05		88		
	24S12		88		
	24S15		88		
	24S24		87		
	48S3P3		87		
	48S05		89		
	48S12		88		
	48S15		88		
	48S24		88		
Isolation Voltage (1 minute) Input to Output Input to Chassis, Output to Chassis	All	1600 1600			VDC
Isolation Resistance (500VDC)	All	1			GΩ
Isolation Capacitance	All			4000	pF
Switching Frequency	All	270	300	330	kHz
Safety Meets	All	IEC60950-1, UL60950-1, EN60950-1			
Weight	All	182			g
MTBF (see page 29) MIL-HDBK-217F Tc=70°C, Full load	All	5.296x 10 ⁵			hours
Chassis Material	All	Aluminum			

Environmental Specifications

Parameter	Model	Min	Typ	Max	Unit
Operating Ambient Temperature	Without derating	-40		+55	°C
	With derating	+55		+99	
Storage Temperature	All	-40		105	°C
Relative Humidity	All	5		95	% RH
Thermal Shock	All	MIL-STD-810F			
Vibration	All	IEC60068-2-6			

EMC Characteristics

Characteristic	Standard	Condition	Level
EMI	EN55022	Module stand-alone	Class B
ESD	EN61000-4-2	Air	±8kV
		Contact	±6kV
Radiated Immunity	EN61000-4-3	10V/m	Perf. Criteria A
Fast Transient (see page 28)	EN61000-4-4	±2kV	Perf. Criteria A
Surge (see page 28)	EN61000-4-5	±1kV	Perf. Criteria A
Conducted Immunity	EN61000-4-6	10V r.m.s	Perf. Criteria A
Power Frequency Magnetic Field	EN61000-4-8	100A/m continuous; 1000A/m 1 second	Perf. Criteria A

Characteristic Curves

All test conditions are at 25°C. The figures are for DPX60-24S3P3

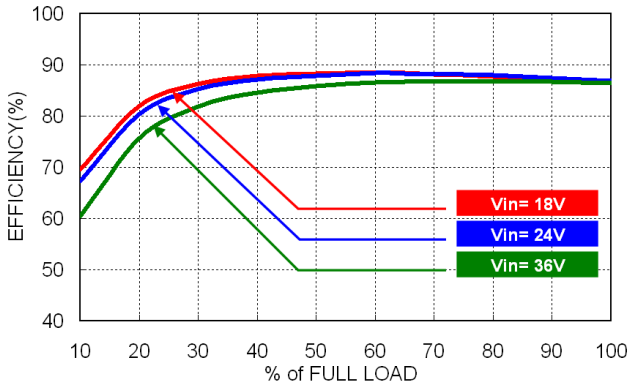

Efficiency versus Output Load

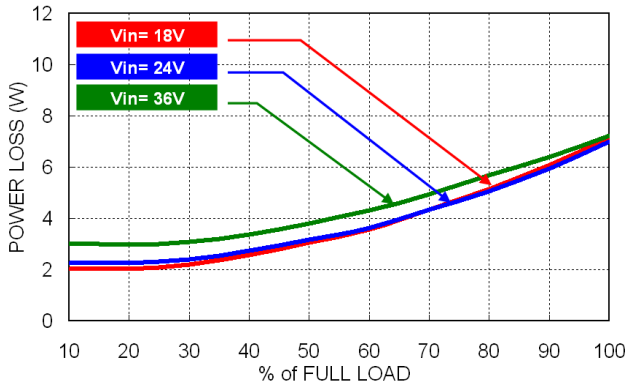

Power Dissipation versus Output Load

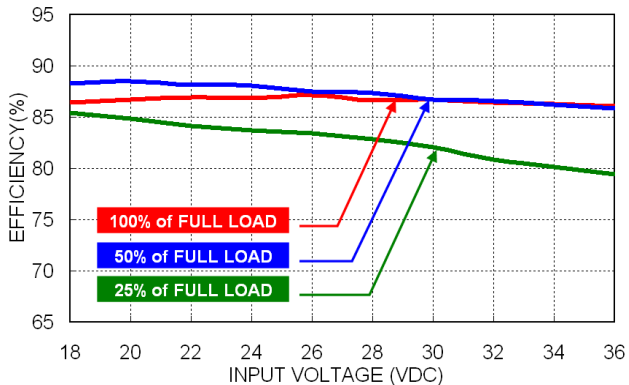

Efficiency versus Input Voltage

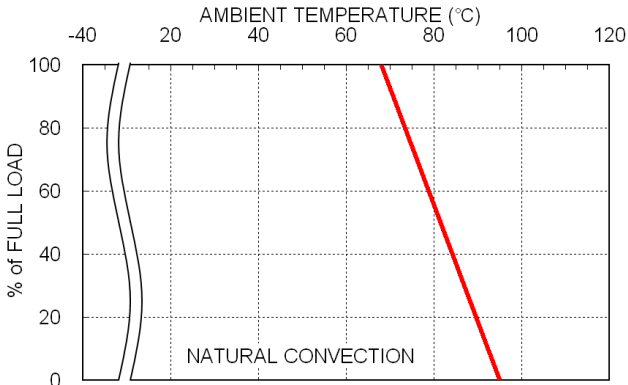

Derating Output Current versus Ambient Temperature and Airflow Vin(nom)

Characteristic Curves (Continued)

All test conditions are at 25°C. The figures are for DPX60-24S3P3

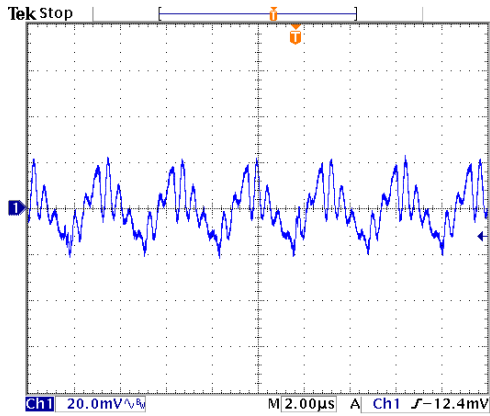

Typical Output Ripple and Noise.
Vin(nom); Full Load

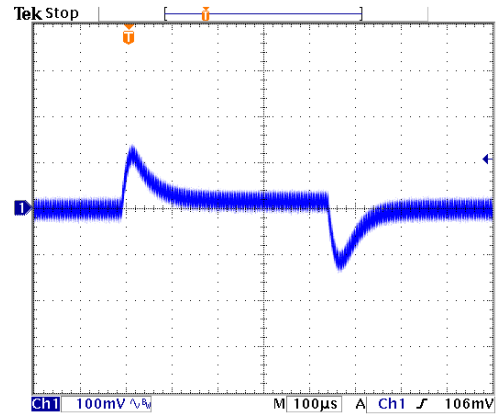

Transient Response to Dynamic Load Change from 100% to 75% to 100% of Full Load; Vin(nom)

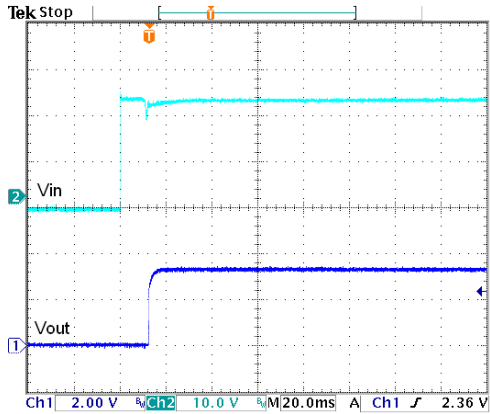

Typical Input Start-Up and Output Rise Characteristic
Vin(nom); Full Load

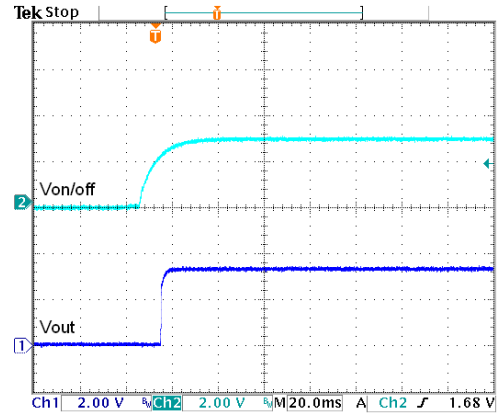

Using ON/OFF Voltage Start-Up and Output Rise Characteristic
Vin(nom); Full Load

Characteristic Curves (Continued)

All test conditions are at 25°C. The figures are for DPX60-24S05

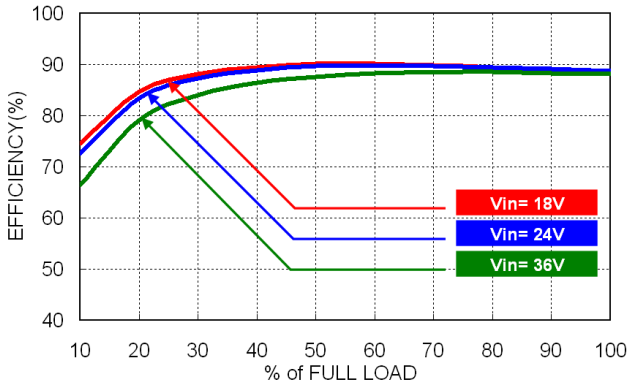

Efficiency versus Output Load

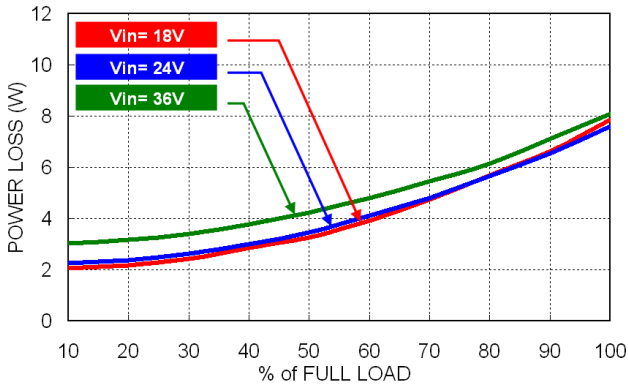

Power Dissipation versus Output Load

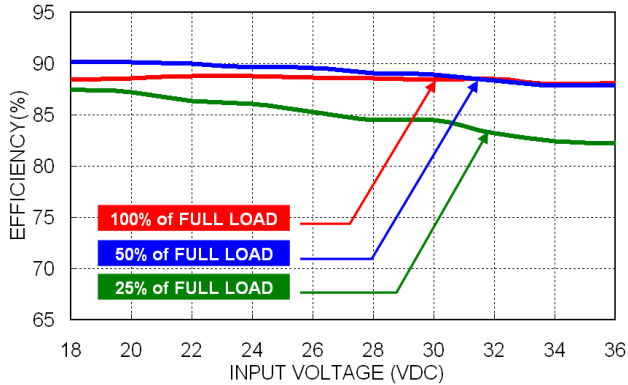

Efficiency versus Input Voltage

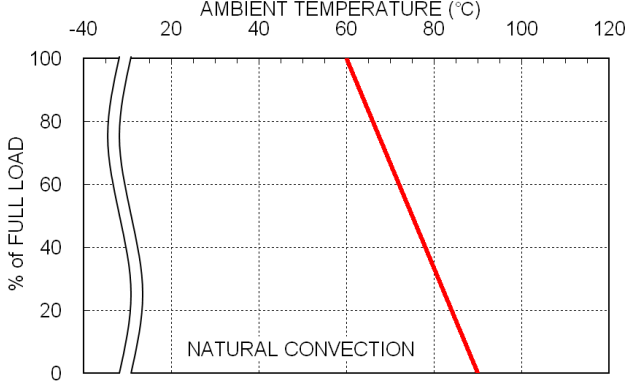

Derating Output Current versus Ambient Temperature and Airflow
Vin(nom)

Characteristic Curves (Continued)

All test conditions are at 25°C. The figures are for DPX60-24S05

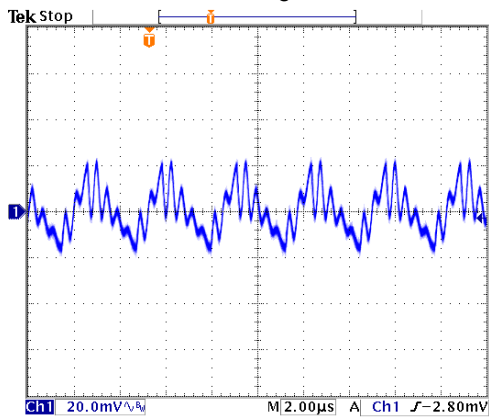

Typical Output Ripple and Noise.
Vin(nom); Full Load

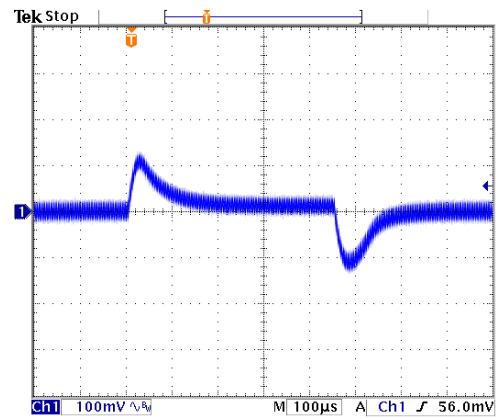

Transient Response to Dynamic Load Change from
100% to 75% to 100% of Full Load; Vin(nom)

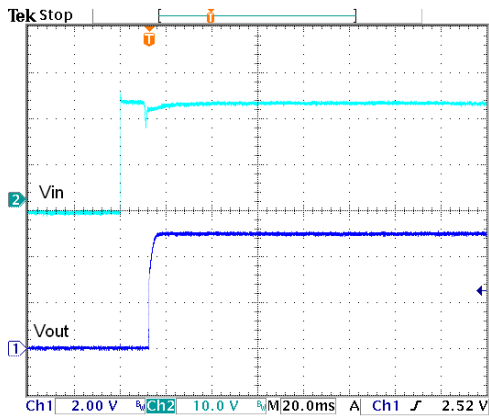

Typical Input Start-Up and Output Rise Characteristic
Vin(nom); Full Load

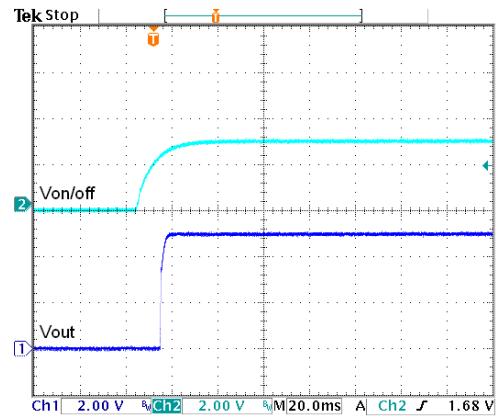

Using ON/OFF Voltage Start-Up and Output Rise Characteristic
Vin(nom); Full Load

Characteristic Curves (Continued)

All test conditions are at 25°C. The figures are for DPX60-24S12

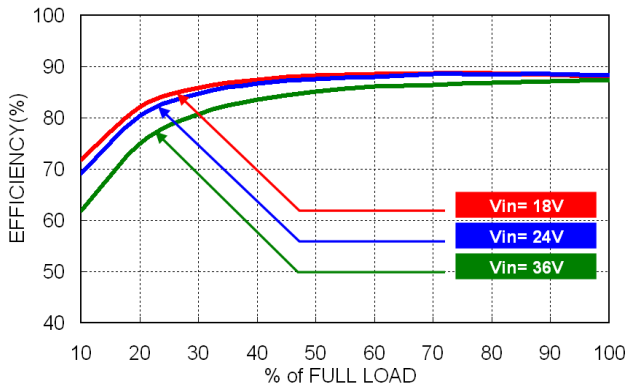

Efficiency versus Output Load

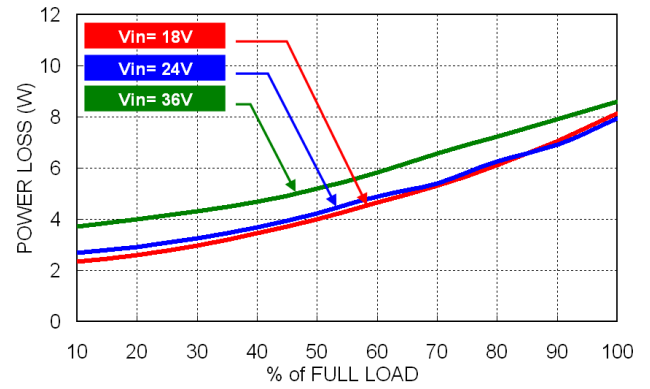

Power Dissipation versus Output Load

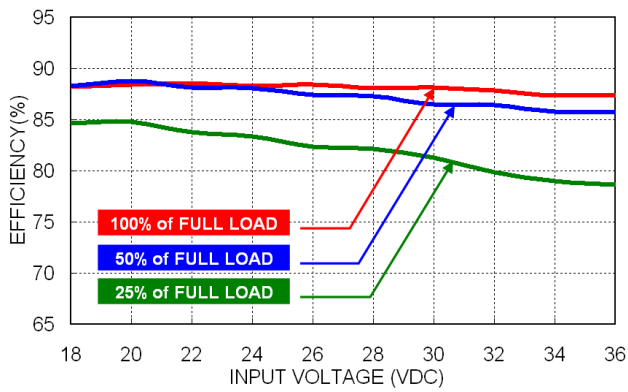

Efficiency versus Input Voltage

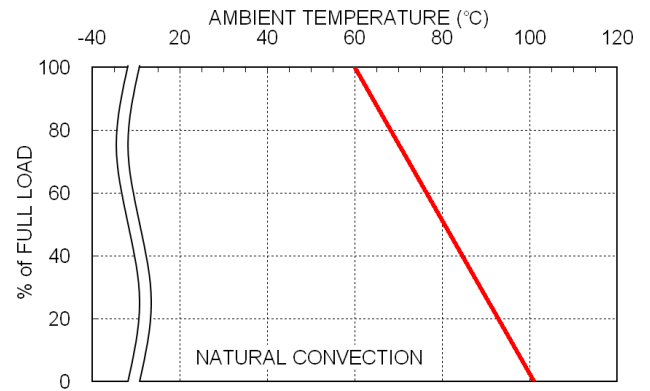

Derating Output Current versus Ambient Temperature and Airflow
V_{in}(nom)

Characteristic Curves (Continued)

All test conditions are at 25°C. The figures are for DPX60-24S12

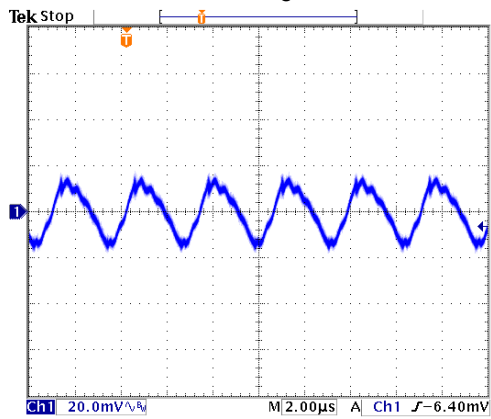

Typical Output Ripple and Noise.
Vin(nom); Full Load

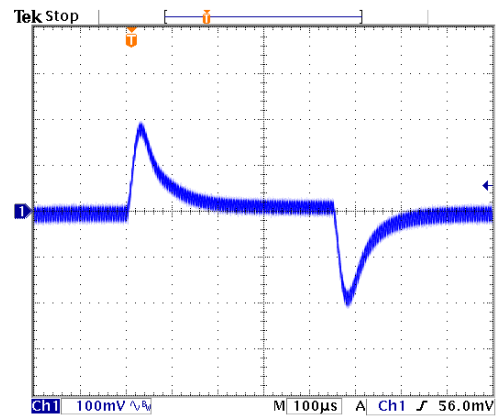

Transient Response to Dynamic Load Change from
100% to 75% to 100% of Full Load; Vin(nom)

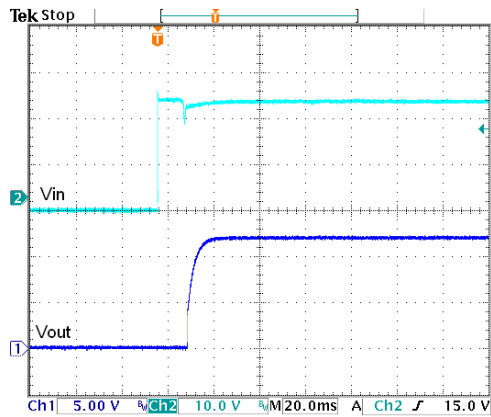

Typical Input Start-Up and Output Rise Characteristic
Vin(nom); Full Load

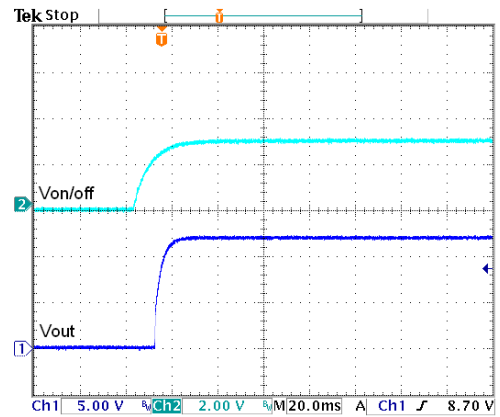

Using ON/OFF Voltage Start-Up and Output Rise Characteristic
Vin(nom); Full Load

Characteristic Curves (Continued)

All test conditions are at 25°C. The figures are for DPX60-24S15

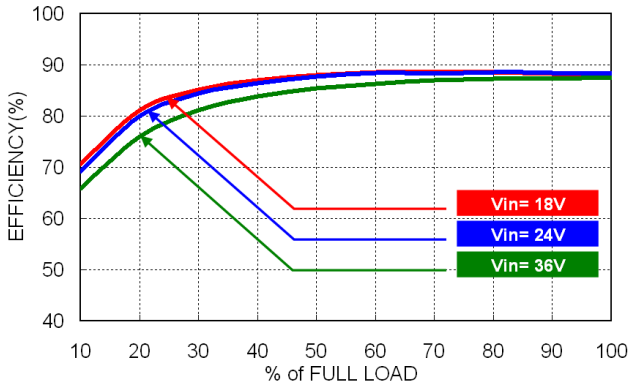

Efficiency versus Output Load

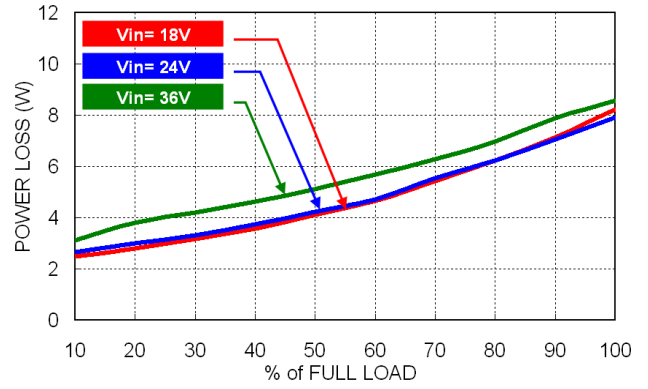

Power Dissipation versus Output Load

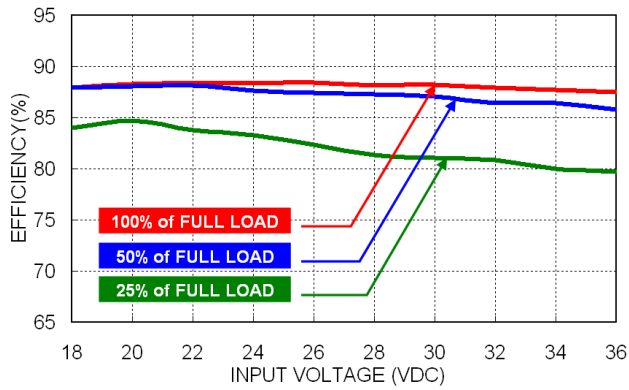

Efficiency versus Input Voltage

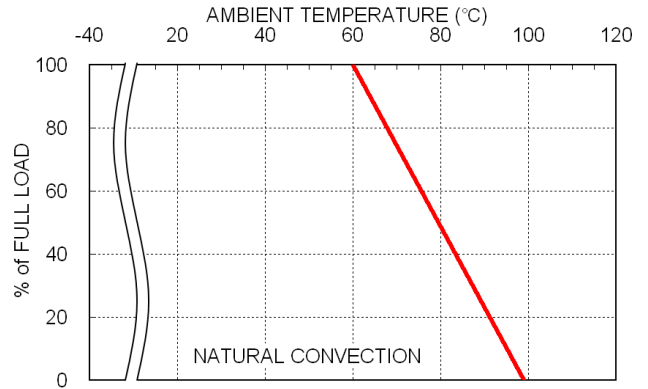

Derating Output Current versus Ambient Temperature and Airflow
Vin(nom)

Characteristic Curves (Continued)

All test conditions are at 25°C. The figures are for DPX60-24S15

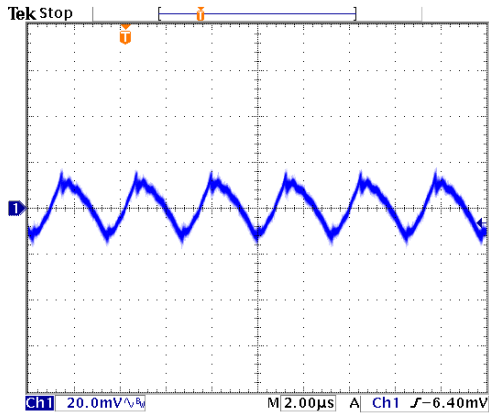

Typical Output Ripple and Noise.
Vin(nom); Full Load

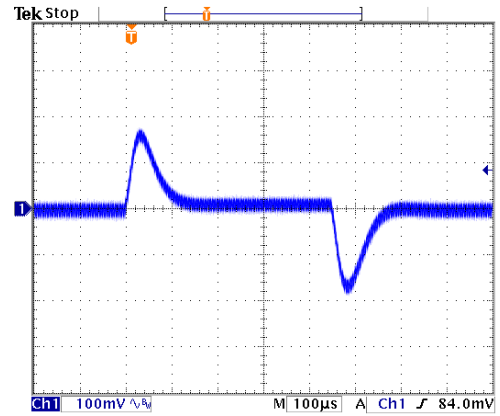

Transient Response to Dynamic Load Change from
100% to 75% to 100% of Full Load; Vin(nom)

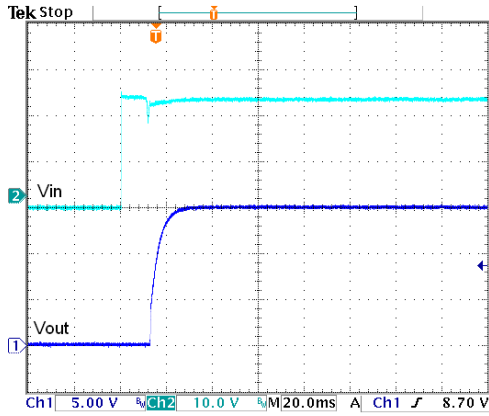

Typical Input Start-Up and Output Rise Characteristic
Vin(nom); Full Load

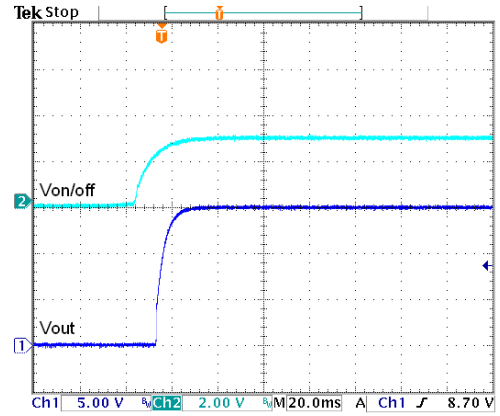

Using ON/OFF Voltage Start-Up and Output Rise Characteristic
Vin(nom); Full Load

Characteristic Curves (Continued)

All test conditions are at 25°C. The figures are for DPX60-24S24

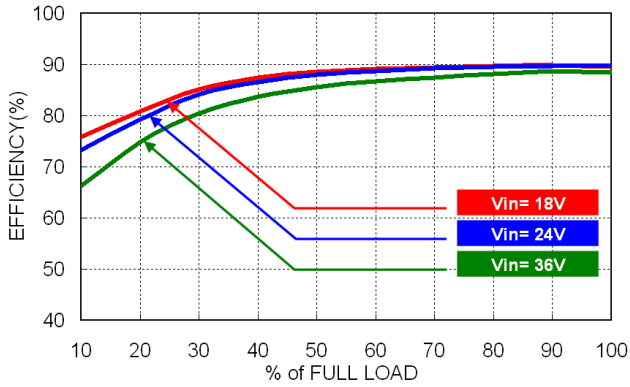

Efficiency versus Output Load

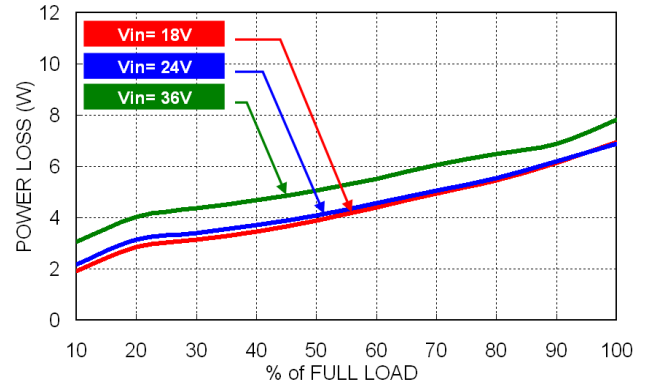

Power Dissipation versus Output Load

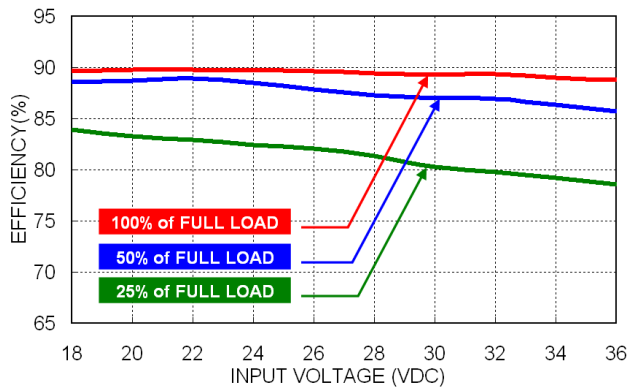

Efficiency versus Input Voltage

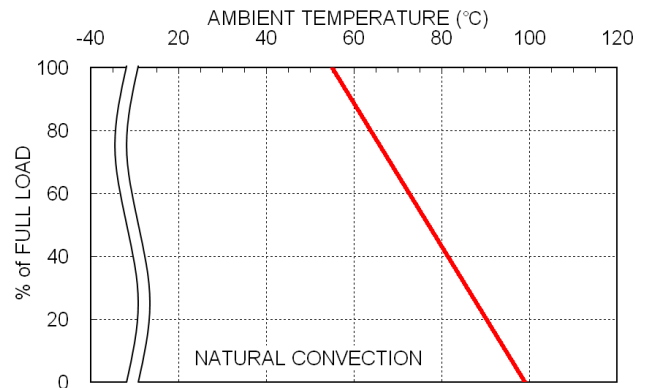

Derating Output Current versus Ambient Temperature and Airflow
Vin(nom)

Characteristic Curves (Continued)

All test conditions are at 25°C. The figures are for DPX60-24S24

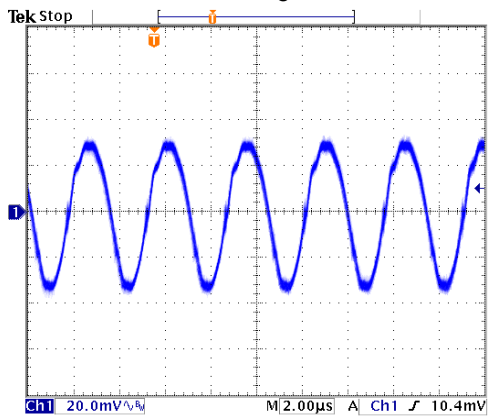

Typical Output Ripple and Noise.
Vin(nom); Full Load

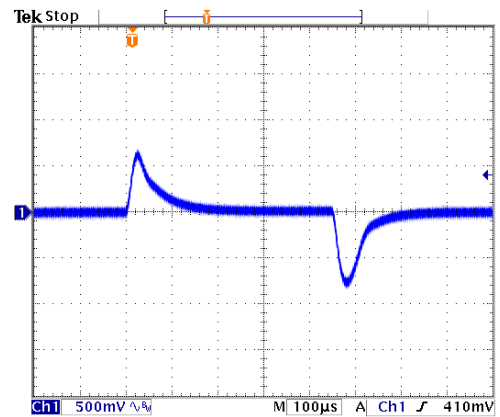

Transient Response to Dynamic Load Change from
100% to 75% to 100% of Full Load; Vin(nom)

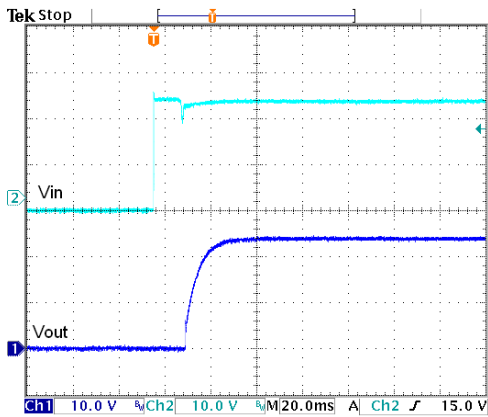

Typical Input Start-Up and Output Rise Characteristic
Vin(nom); Full Load

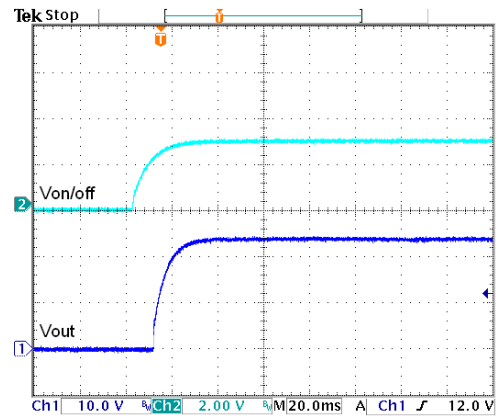

Using ON/OFF Voltage Start-Up and Output Rise Characteristic
Vin(nom); Full Load

Characteristic Curves (Continued)

All test conditions are at 25°C. The figures are for DPX60-48S3P3

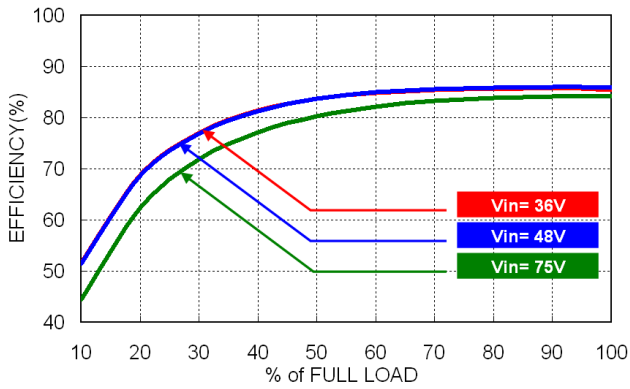

Efficiency versus Output Load

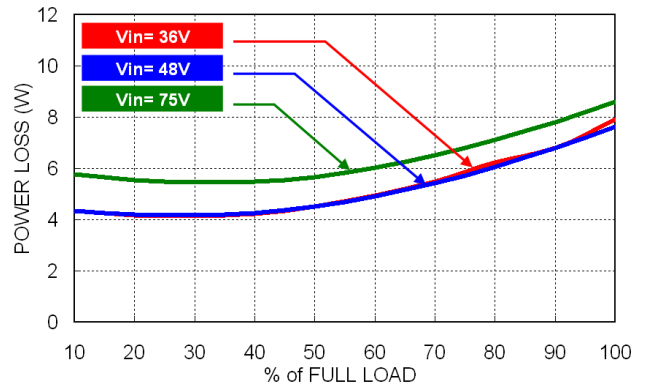

Power Dissipation versus Output Load

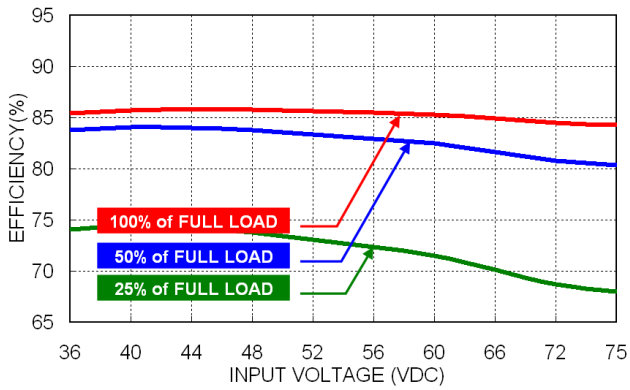

Efficiency versus Input Voltage

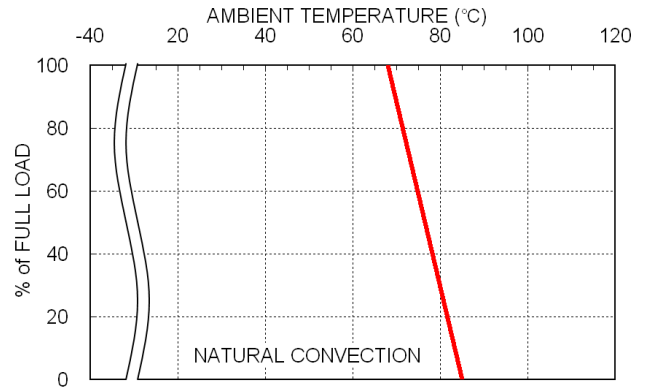

Derating Output Current versus Ambient Temperature and Airflow Vin(nom)

Characteristic Curves (Continued)

All test conditions are at 25°C. The figures are for DPX60-48S3P3

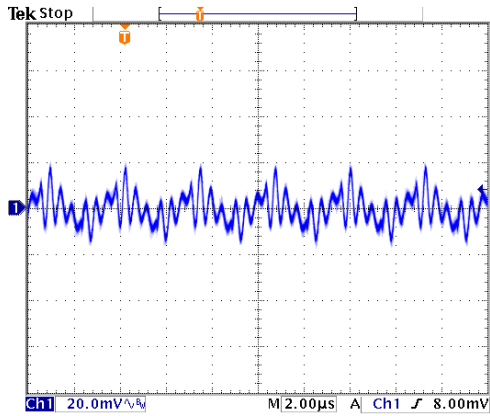

Typical Output Ripple and Noise.
Vin(nom); Full Load

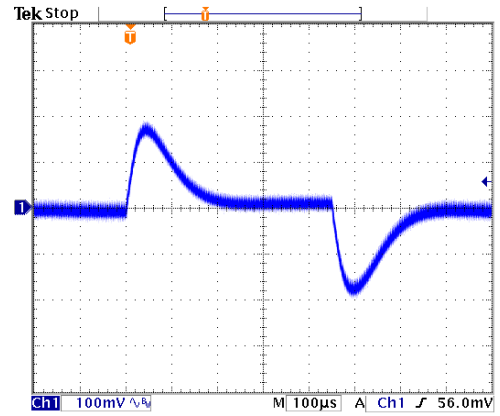

Transient Response to Dynamic Load Change from
100% to 75% to 100% of Full Load; Vin(nom)

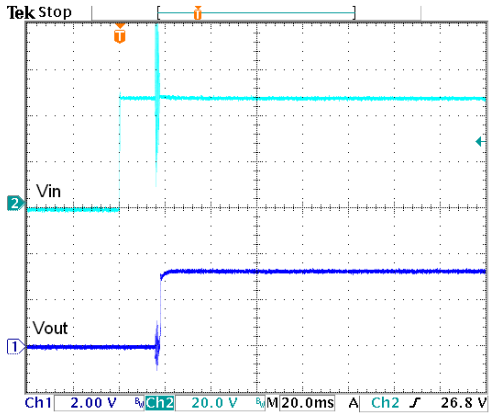

Typical Input Start-Up and Output Rise Characteristic
Vin(nom); Full Load

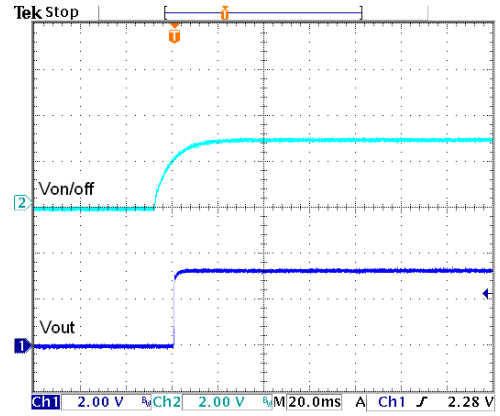

Using ON/OFF Voltage Start-Up and Output Rise Characteristic
Vin(nom); Full Load

Characteristic Curves (Continued)

All test conditions are at 25°C. The figures are for DPX60-48S05

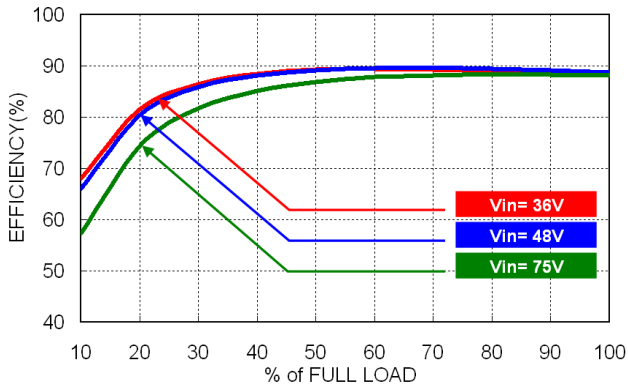

Efficiency versus Output Load

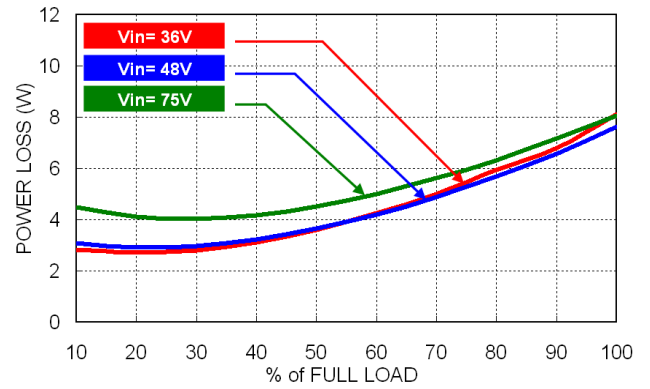

Power Dissipation versus Output Load

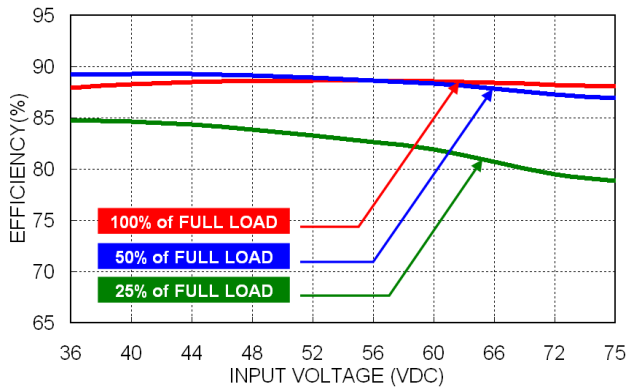

Efficiency versus Input Voltage

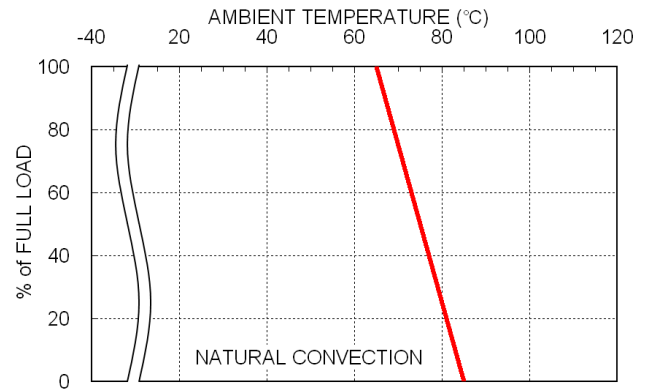

Derating Output Current versus Ambient Temperature and Airflow
Vin(nom)

Characteristic Curves (Continued)

All test conditions are at 25°C. The figures are for DPX60-48S05

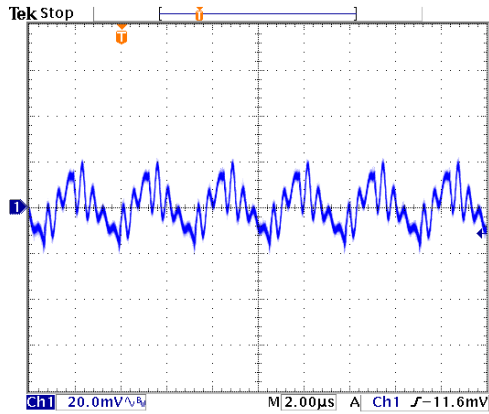

Typical Output Ripple and Noise.
Vin(nom); Full Load

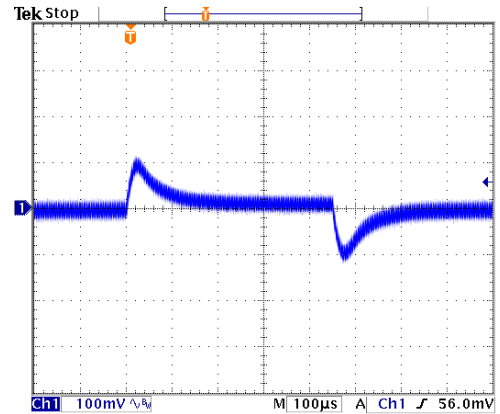

Transient Response to Dynamic Load Change from
100% to 75% to 100% of Full Load; Vin(nom)

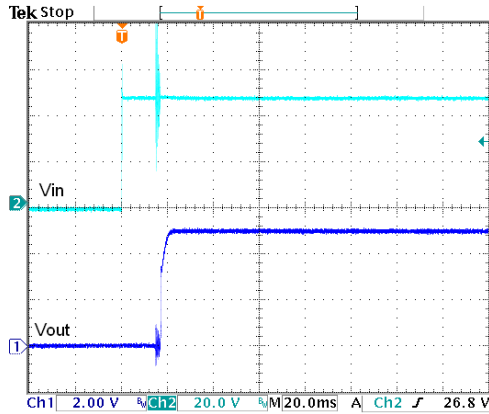

Typical Input Start-Up and Output Rise Characteristic
Vin(nom); Full Load

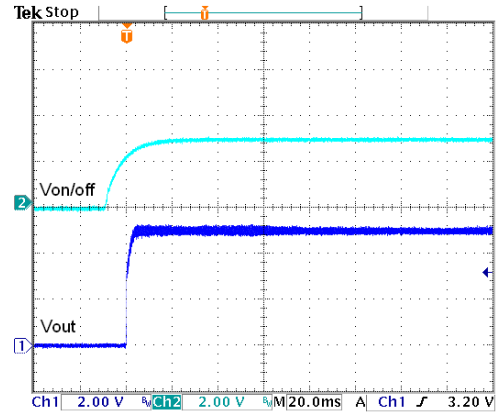

Using ON/OFF Voltage Start-Up and Output Rise Characteristic
Vin(nom); Full Load

Characteristic Curves (Continued)

All test conditions are at 25°C. The figures are for DPX60-48S12

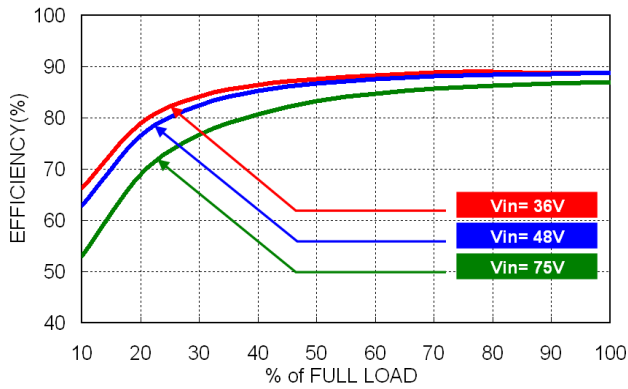

Efficiency versus Output Load

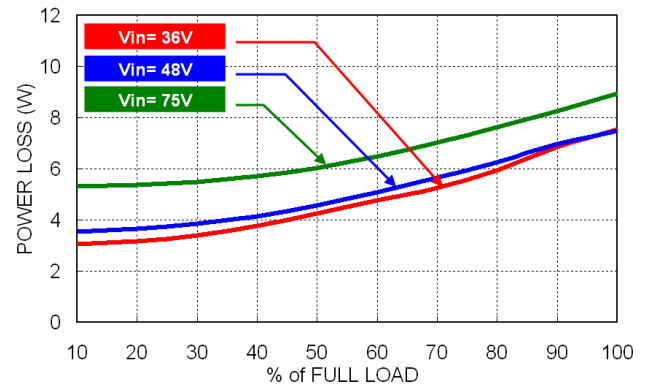

Power Dissipation versus Output Load

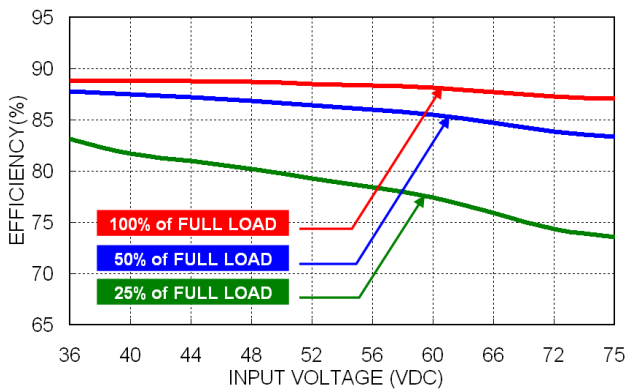

Efficiency versus Input Voltage

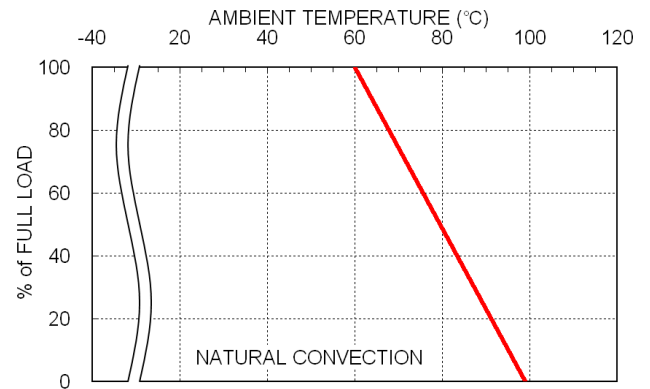

Derating Output Current versus Ambient Temperature and Airflow
Vin(nom)

Characteristic Curves (Continued)

All test conditions are at 25°C. The figures are for DPX60-48S12

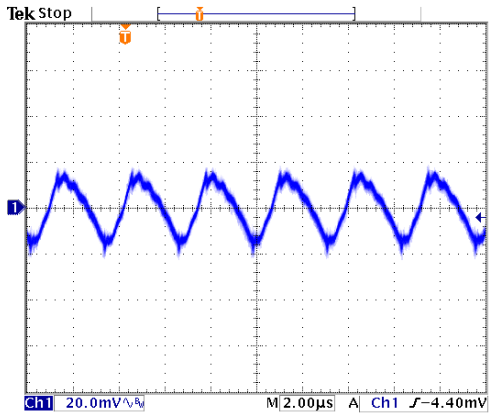

Typical Output Ripple and Noise.
Vin(nom); Full Load

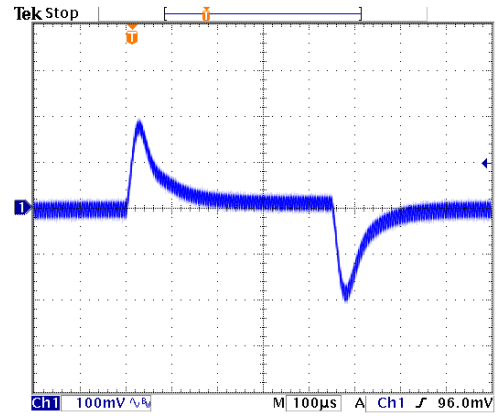

Transient Response to Dynamic Load Change from
100% to 75% to 100% of Full Load; Vin(nom)

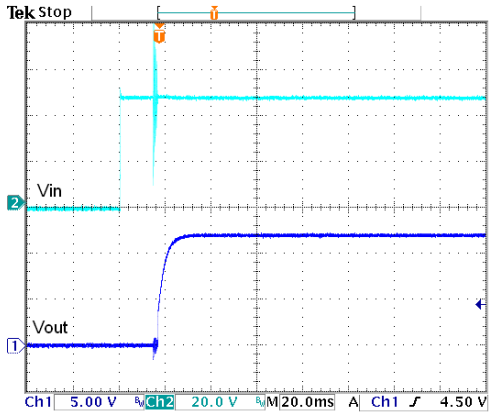

Typical Input Start-Up and Output Rise Characteristic
Vin(nom); Full Load

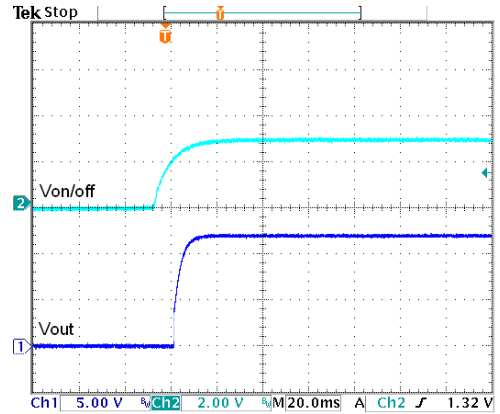

Using ON/OFF Voltage Start-Up and Output Rise Characteristic
Vin(nom); Full Load

Characteristic Curves (Continued)

All test conditions are at 25°C. The figures are for DPX60-48S15

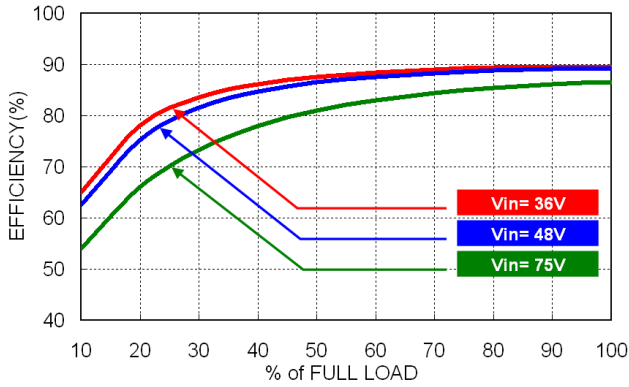

Efficiency versus Output Load

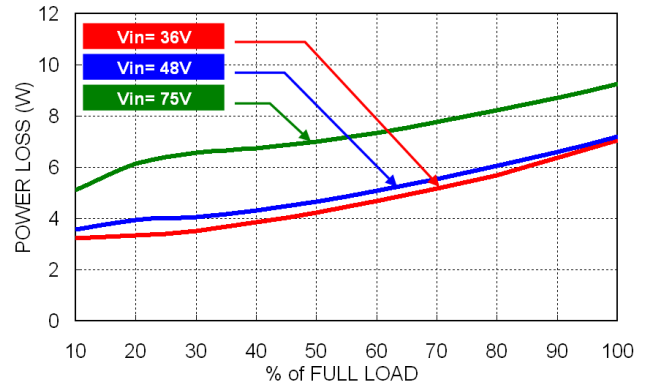

Power Dissipation versus Output Load

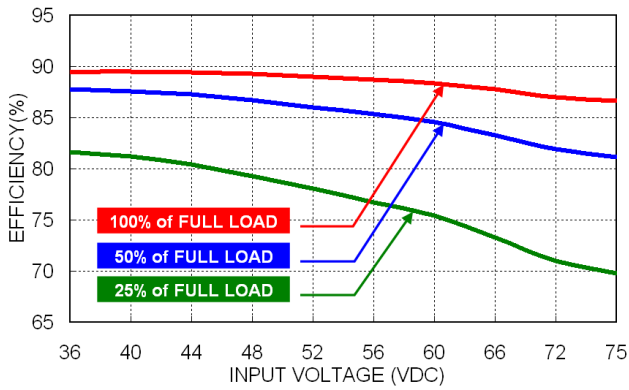

Efficiency versus Input Voltage

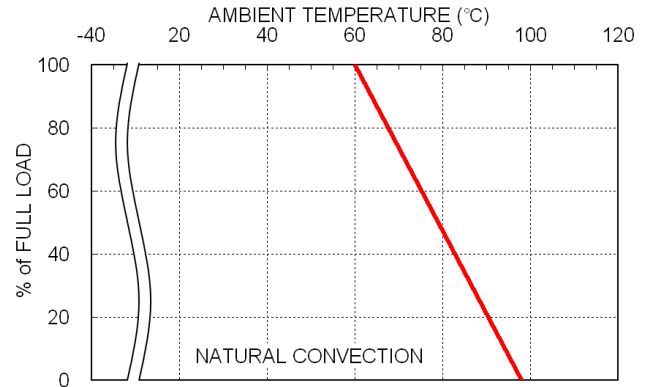

Derating Output Current versus Ambient Temperature and Airflow Vin(nom)

Characteristic Curves (Continued)

All test conditions are at 25°C. The figures are for DPX60-48S15

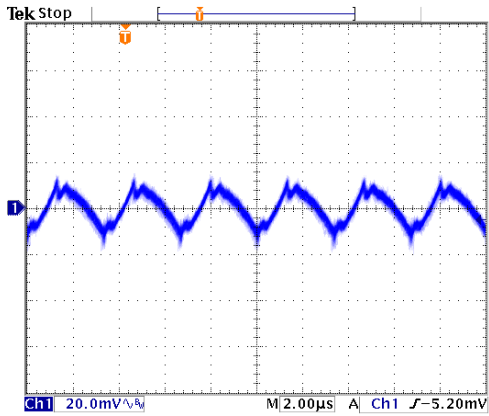

Typical Output Ripple and Noise.
Vin(nom); Full Load

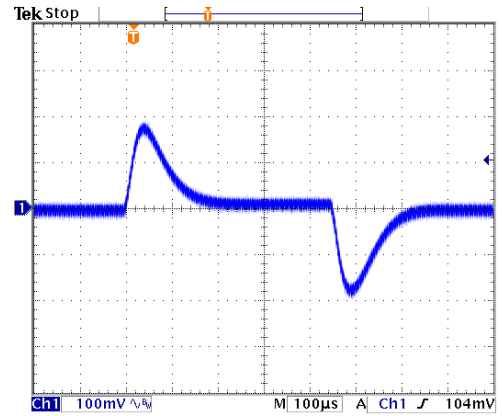

Transient Response to Dynamic Load Change from 100% to 75% to 100% of Full Load; Vin(nom)

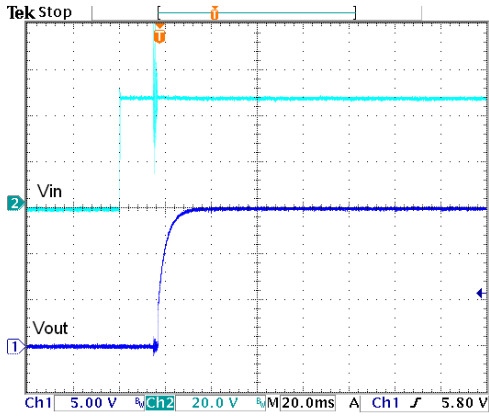

Typical Input Start-Up and Output Rise Characteristic
Vin(nom); Full Load

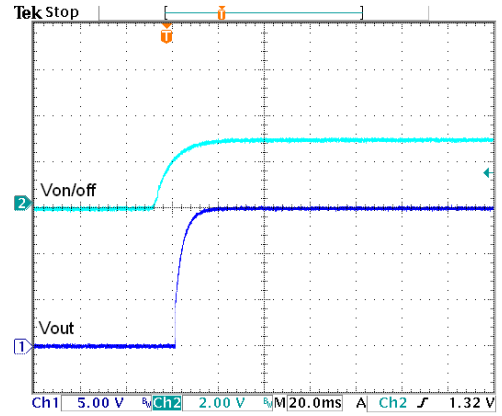

Using ON/OFF Voltage Start-Up and Output Rise Characteristic
Vin(nom); Full Load

Characteristic Curves (Continued)

All test conditions are at 25°C. The figures are for DPX60-48S24

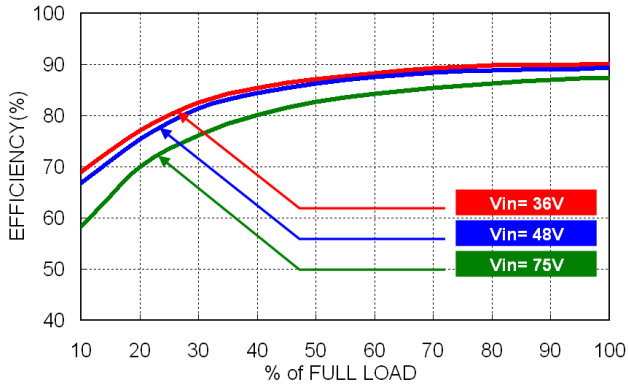

Efficiency versus Output Load

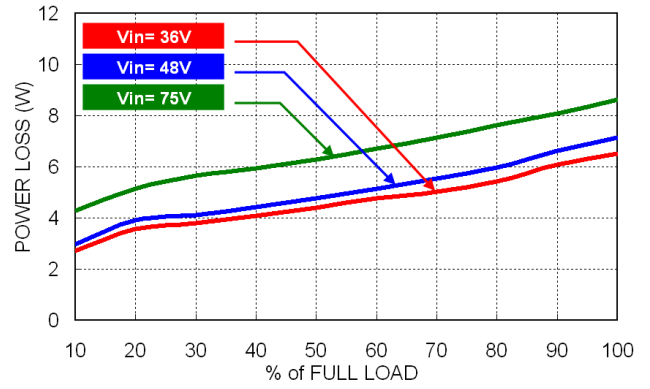

Power Dissipation versus Output Load

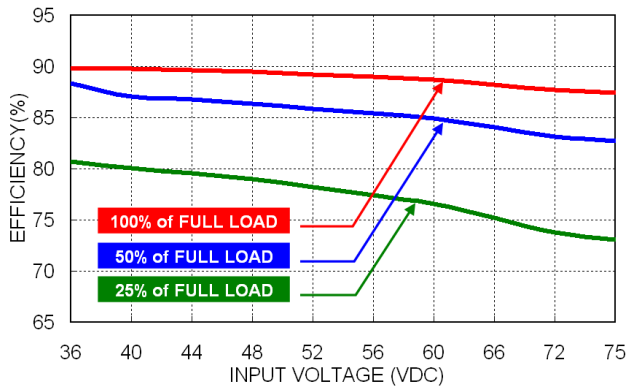

Efficiency versus Input Voltage

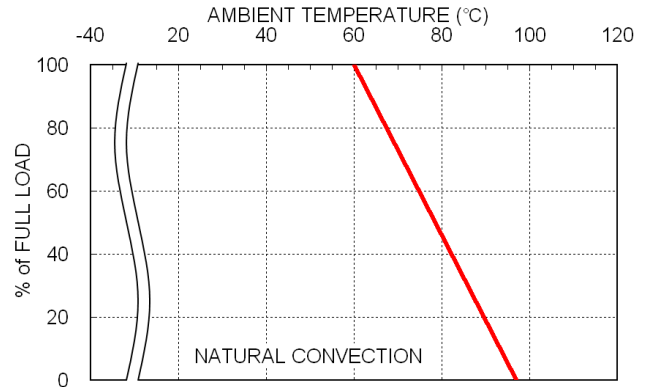

Derating Output Current versus Ambient Temperature and Airflow Vin(nom)

Characteristic Curves (Continued)

All test conditions are at 25°C. The figures are for DPX60-48S24

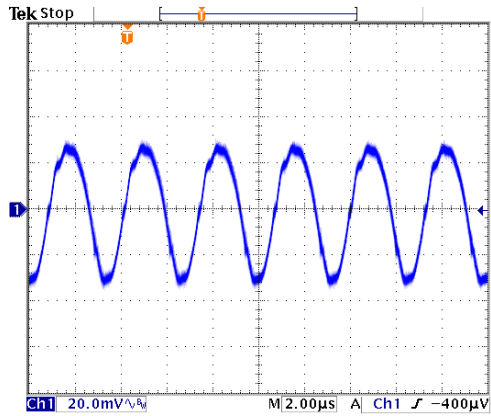

Typical Output Ripple and Noise.
Vin(nom); Full Load

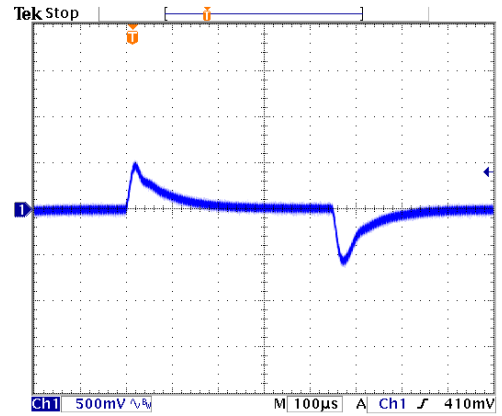

Transient Response to Dynamic Load Change from
100% to 75% to 100% of Full Load; Vin(nom)

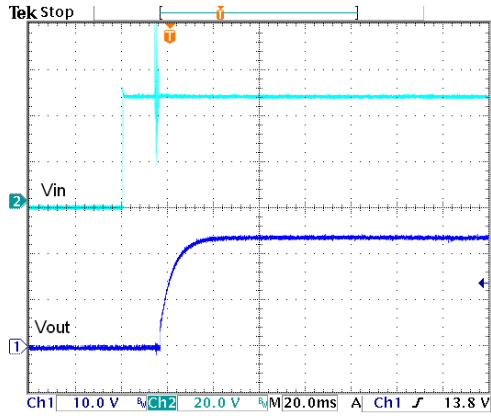

Typical Input Start-Up and Output Rise Characteristic
Vin(nom); Full Load

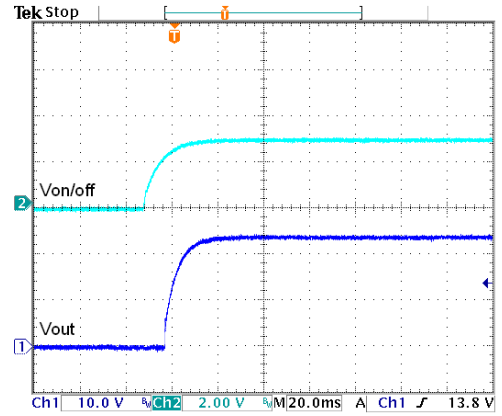

Using ON/OFF Voltage Start-Up and Output Rise Characteristic
Vin(nom); Full Load

Input Source Impedance

The power module should be connected to a low impedance input source. Highly inductive source impedance can affect the stability of the power module. The input reflected-ripple current measurement configuration is shown below:

Input reflected-ripple current measurement setup

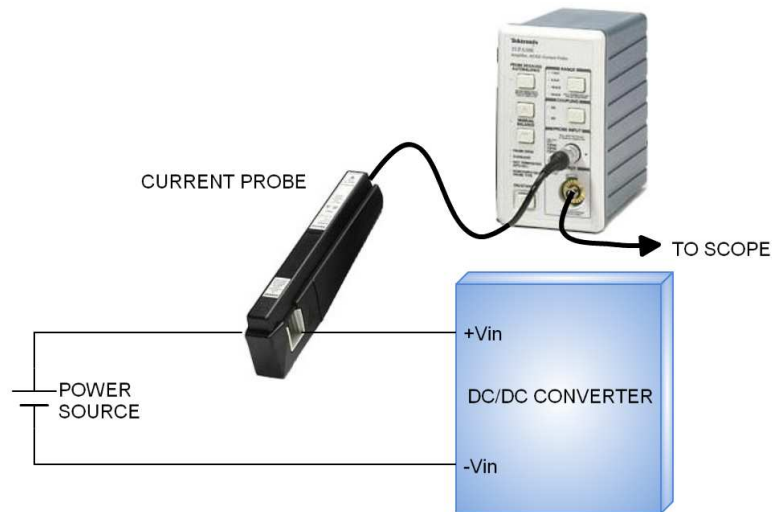

Output Over Current Protection

When excessive output currents occur in the system, circuit protection is required on all power supplies. Normally, overload current is maintained at approximately 150 percent of rated current for DPX60-xxSxx series.

Hiccup-mode is a method of operation in a power supply whose purpose is to protect the power supply from being damaged during an over-current fault condition. It also enables the power supply to restart when the fault is removed. There are other ways of protecting the power supply when it is over-loaded, such as the maximum current limiting or current fold-back methods.

One of the problems resulting from over current is that excessive heat may be generated in power devices; especially MOSFET and Schottky diodes and the temperature of those devices may exceed their specified limits. A protection mechanism has to be used to prevent those power devices from being damaged.

The operation of hiccup is as follows. When the current sense circuit sees an over-current event, the controller shuts off the power supply for a given time and then tries to start up the power supply again. If the over-load condition has been removed, the power supply will start up and operate normally; otherwise, the controller will see another over-current event and shut off the power supply again, repeating the previous cycle. Hiccup operation has none of the drawbacks of the other two protection methods, although its circuit is more complicated because it requires a timing circuit. The excess heat due to overload lasts for only a short duration in the hiccup cycle, hence the junction temperature of the power devices is much lower.

The hiccup operation can be done in various ways. For example, one can start hiccup operation any time an over-current event is detected; or prohibit hiccup during a designated start-up interval (usually a few milliseconds). The reason for the latter operation is that during start-up, the power supply needs to provide extra current to charge up the output capacitor. Thus the current demand during start-up is usually larger than during normal operation and it is easier for an over-current event to occur. If the power supply starts to hiccup once there is an over-current, it might never start up successfully. Hiccup mode protection will give the best protection for a power supply against over current situations, since it will limit the average current to the load at a low level, so reducing power dissipation and case temperature in the power devices.

Output Short Circuit Protection

Continuous and auto-recovery mode.

During a short circuit, the converter will shut down. The average current during this condition will be very low.

Output Over Voltage Protection

The output over-voltage protection consists of an output Zener diode that monitors the voltage at the output terminals. If the voltage at the output terminals exceeds the over-voltage protection threshold, then the Zener diode clamps the output voltage.

Remote On/off Control

The Ctrl Pin is used to turn the DC/DC power module on and off. The user must use a switch to control the logic voltage (high or low) level of the pin referenced to $-V_{in}$. The switch can be an open collector transistor, FET, or Photo-Coupler. The switch must be capable of sinking up to 1 mA at low-level logic voltage. A High-level logic of the Ctrl pin signal should be limited to a maximum voltage of 12V and a maximum current of 0.5 mA.

Remote ON/OFF Implementation

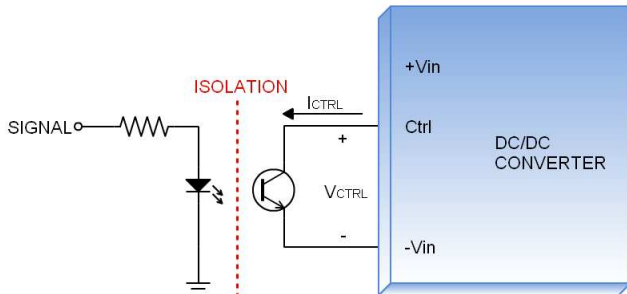

Isolated-Closure Remote ON/OFF

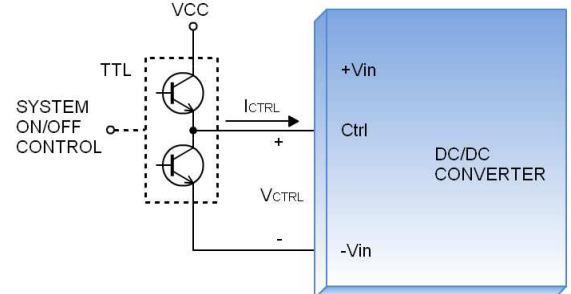

Level Control Using TTL Output

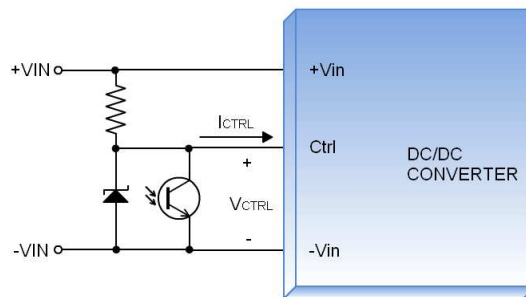

Level Control Using Line Voltage

There are two remote control options available, positive logic (optional) and negative logic (optional).

a. The positive logic structure turns on the DC/DC module when the Ctrl pin is at high- logic level and turns the module off using a low-logic level.

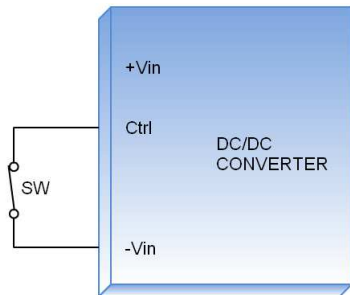

When DPX60-xxSxx-P module is turned off using a Low- logic level

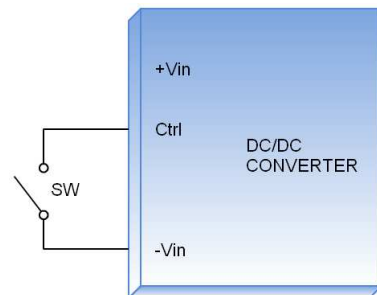

When DPX60-xxSxx-P module is turned on using a High- logic level

b. The negative logic structure turns on the DC/DC module when the Ctrl pin is at low- logic level and turns the module off when using a high-level logic.

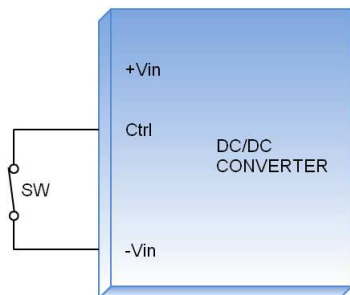

When DPX60-xxSxx-N module is turned on using a Low- logic level

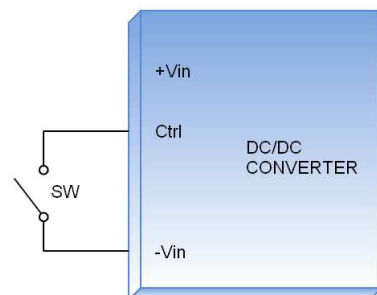

When DPX60-xxSxx-N module is turned off using a High-logic level

EMS Considerations

The DPX60 series can meet Fast Transient EN61000-4-4 and Surge EN61000-4-5 performance criteria A. Please see the following schematic.

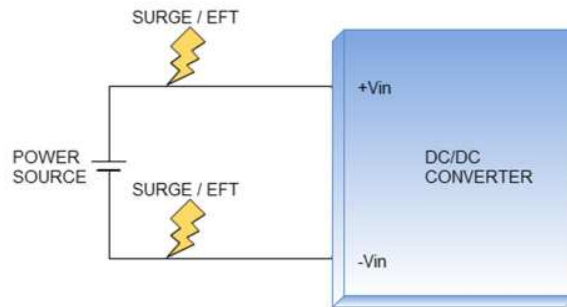

Mechanical Data

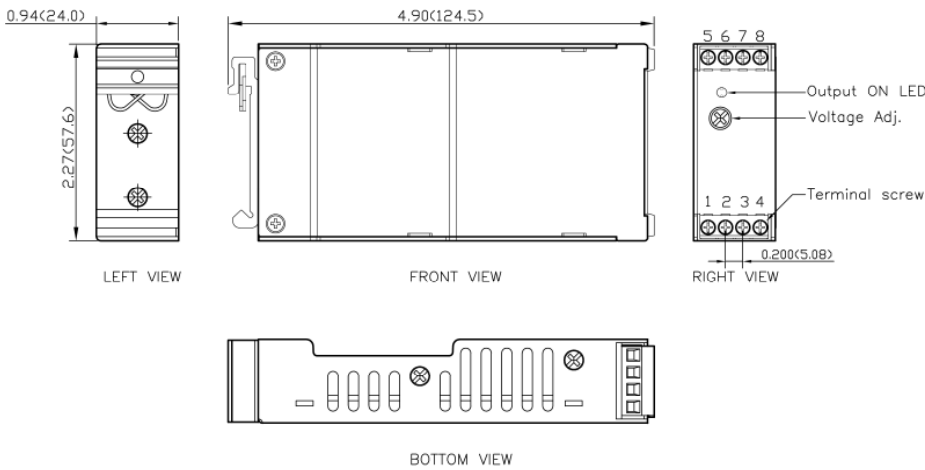

PIN CONNECTION

PIN	FUNCTION
1	Ctrl
2	-Vin
3	-Vin
4	+Vin
5	NC
6	-Vout
7	+Vout
8	NC

* NC : No Connection

* Screw terminals—wire range from 14 to 18 AWG

1. All dimensions in inch (mm)
2. Tolerance : X.XX±0.02 (X.X±0.5)
X.XXX±0.01 (X.XX±0.25)
3. Terminal screw locked torque :
MAX 2.5kgf—cm (0.25N—m)

Packaging Information

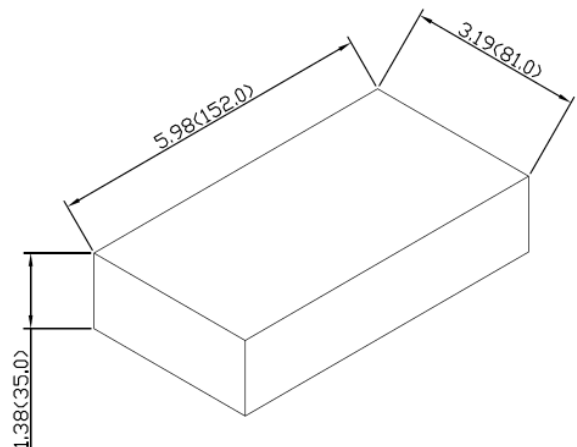
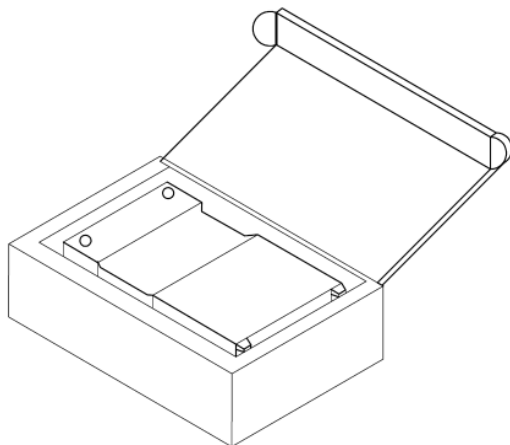

1PCS / BOX
All dimensions in mm

Part Number Structure

DPX60	-	48	S	05	-	N
Series Name		Input Voltage (VDC)	Output Quantity	Output Voltage (VDC)		Remote Control options
		24: 18~36 48: 36~75	S: Single	3P3: 3.3 05: 5 12: 12 15: 15 24: 24		P: Positive logic N: Negative logic

Model Number	Input Range VDC	Output Voltage VDC	Output Current @ Full Load A	Input Current @ No Load mA	Efficiency %	Maximum Capacitor Load μ F
DPX60-24S3P3	18 ~ 36	3.3	14	104	87	36000
DPX60-24S05	18 ~ 36	5	12	134	88	20400
DPX60-24S12	18 ~ 36	12	5	59	88	3550
DPX60-24S15	18 ~ 36	15	4	74	88	2300
DPX60-24S24	18 ~ 36	24	2.5	76	87	885
DPX60-48S3P3	36 ~ 75	3.3	14	102	87	36000
DPX60-48S05	36 ~ 75	5	12	94	89	20400
DPX60-48S12	36 ~ 75	12	5	37	88	3550
DPX60-48S15	36 ~ 75	15	4	42	88	2300
DPX60-48S24	36 ~ 75	24	2.5	45	88	885

MTBF and Reliability

The MTBF of DPX60-xxSxx series of DC/DC converters has been calculated using MIL-HDBK 217F NOTICE2 FULL LOAD, Tc=70°C. The resulting figure for MTBF is 5.296×10⁵ hours.