



NV-300

300 Watts

Flexible Power Solution

- High Efficiency
- High Power Density (8.3W/in³)
- Up to 5 outputs
- No minimum load
- Fits 1U applications
- Medical Approval
- 3 Year Warranty
- Temperature controlled Fan Option

Key Market Segments & Applications

Instrumentation	Broadcast
Medical	ATE
Automation	Industrial Computing
Security	Lifesciences/Laboratory
Network Servers and Routers	

Features and Benefits

Features

- High Efficiency
- Low Profile
- High Power Density

Benefits

- Minimises heat in system
- Fits 1U applications
- Less Space

INPUT			
Input Voltage	90 - 264Vac / 120 - 350Vdc (Below 100Vac input, derate by 3W per Volt)	Input Frequency	45 - 63Hz (440Hz with reduced PFC - consult factory)
Input Harmonics	EN61000-3-2 compliant	Inrush Current	15A (typical) at 20°C and 264Vac, (cold start)
Input Fuse	6.3A, Fast acting (not user accessible)	Power Factor	0.97 typical
Earth Leakage Current	123µA max at 120Vac (60Hz), 257µA max at 240Vac (60Hz) Worst case leakage current is less than 300µA at 264Vac, 63Hz (normal condition, 500µA Single Fault Condition)		

AVAILABLE OUTPUTS											
Channel 1	Adjustment Range ₅	Channel 2 ₁	Adjustment Range ₅	Channel 3	Adjustment Range	Channel 4 ₃	Adjustment Range				
5 5V / 40A ₂	5 - 5.5V	1 1.8V / 15A	0.9 - 2.5V								
		2 2.7V / 15A	2.5 - 3.8V								
T 12V / 25A	12 - 13V	3 3.3V / 15A	2.5 - 3.8V								
		2H 2.7V / 24A	2.5 - 3.8V								
		3H 3.3V / 24A	2.5 - 3.8V								
G 24V / 12.5A	24 - 28V ₇	0 Omit									
		5 5V / 10A	3.3 - 5.5V					T 12V / 5A ₄	12 - 15V	3H -3.3V / 2A ₈	Fixed
		5H 5V / 16A	3.3 - 5.5V					TH 12V / 8A ₆	12 - 15V	5H -5V / 2A ₈	
		0 Omit						F 15V / 4A ₄	12 - 15V	TH -12V / 2A ₈	
5 5V / 8A	5 - 5.5V	FH 15V / 6.4A ₆	12 - 15V	FH -15V / 2A ₈							
		5H 5V / 12.5A	5 - 5.5V	G 24V / 2.5A	18 - 24V	0H Fan supply only					
		T 12V / 10A	12 - 15.5V	0 Omit		0 Omit					
		F 15V / 10A	12 - 15.5V								
		0 Omit									

- 1, 2, 3, 2H & 3H channel 2 only available with 5V channel 1.
5V / 10A channel 2 only available with 12 or 15V channel 1
5V / 8A channel 2 only available with 24V channel 1
- Maximum combined output current from Ch1 & Ch2 = 40A
- Follow letters in red by 'P' for positive output channel 4.
- 60W max output power
- Max voltage at the output (includes remote sense)
- 96W max output power
- 24 - 24.5V if 5V channel 2 fitted
24 - 26V if 24V channel 3 fitted
- 1.5A max if fitted with '-F' option.

Other output options are available, please contact factory with your requirements.



ISOLATION			
Input to Output	Reinforced	4.3kV (dc)	Note: Basic for IEC/EN/UL/CSA60601-1
Input to Earth	Basic	2.25 kV (dc)	Output to Earth 200 V (dc)

OUTPUT SPECIFICATION		
Remote Sense	Yes	Channels 1 & 2 - Max 0.5V total line drop.
Total Regulation	1.5%	For channels 1, 2 and 3 (2.5% for channel 4) Including Line (for 90-264Vac input change), Load (for 0-100% load change) and Cross (for 0-100% load change on any other output) regulation.
Ripple & Noise	1%	(or 50mV if higher) pk-pk, using EIAJ test method & 20MHz bandwidth 1.5% for units with 5V Channel 1
Voltage Accuracy	±1%	±5% for Channel 4
Turn on Time	1.5s max	at 90 Vac & 100% rated output power
Efficiency	up to 90%	configuration dependent
Hold up	16ms min	at 90 Vac
Min Load	None	on any output
Transient Response	<5%	of set voltage for 40% load change (in 50µs within the range 25 - 100% load)
Recovery	<500µs	for recovery to 1% of set voltage
Short circuit protection	Yes	
Over Temperature protection	Yes	
Over Voltage Protection	Yes	See Application Notes for details
Ch1 Good Signal	Yes	Provides a Logic 'Low' signal after Channel 1 output is within 90% (±5%) of nominal.
Output Power	300W	Total output power from all outputs (for Vin below 180Vac including standby supply) for Vin above 180Vac, max output power = 300W + standby supply

HOW TO CREATE A PRODUCT CODE

NVA3-	#o/p	Ch1	Ch2	Ch3	Ch4	Global Option	Case Option
	↑	↑	↑	↑	↑	↑	↑

Number of outputs (excluding standby supply) → #o/p

Ch1 - Ch4 Letter/number from table on page 1 to represent output voltage.

(Blank = no case)
-C = U Chassis + Cover
-U = U Chassis
-F = End fan + case₁
-I = IEC input, End fan + case₁

(Blank = no option)
-N3 = 5V/2A ATX compatible
-N4 = 12V/1A ATX compatible

1. Needs 0H, 3H, 5H, TH or FH type channel 4. **The fan speed is temperature dependent, ensuring optimum cooling and lowest audible noise.**

Confirm availability of created product code with the factory

QUICK SELECTOR - preferred configurations						
Model	CH1	CH2	CH3	CH4	CH5	Global Option ₁
NVA3-453TTH	5V / 40A	3.3V / 15A	12V / 5A	-12V / 2A	-	No
NVA3-453TTH-N3	5V / 40A	3.3V / 15A	12V / 5A	-12V / 2A	5V / 2A	ATX (-N3)
NVA3-350TTH	5V / 40A	-	12V / 5A	-12V / 2A	-	No
NVA3-350TTH-N3	5V / 40A	-	12V / 5A	-12V / 2A	5V / 2A	ATX (-N3)
NVA3-453FFH	5V / 40A	3.3V / 15A	15V / 5A	-15V / 2A	-	No
NVA3-453FFH-N3	5V / 40A	3.3V / 15A	15V / 5A	-15V / 2A	5V / 2A	ATX (-N3)
NVA3-350FFH	5V / 40A	-	15V / 5A	-15V / 2A	-	No
NVA3-350FFH-N3	5V / 40A	-	15V / 5A	-15V / 2A	5V / 2A	ATX (-N3)

Above Units available on rapid delivery. See over for additional variants available 'Build to Order'

1. see page 3 for details of global option



GLOBAL SIGNALS (-N3 and -N4 Option Models)	
ATX Remote on/off	TTL logic level high or open circuit will inhibit all outputs (except Standby)
ATX Power Good	Logic high indicates ac supply is good and output 1 is within regulation.
Standby Supply	Common 0V with power supply. Not affected by ATX remote on/off -N3 Option = 5V / 2A -N4 Option = 12V / 1A.

IMMUNITY EN61000-6-2:2005, EN60601-1-2:2001				Criteria
Electrostatic Discharge	EN61000-4-2	Level 4	Air discharge 15kV Contact discharge 8kV Not applicable to open frame units	A
Electromagnetic Field	EN61000-4-3	Level 3	(12V/m)	A
Fast / Burst Transient (ac input)	EN61000-4-4	Level 4	(tested to 4.4kV)	A
Fast / Burst Transient (dc output)	EN61000-4-4	Level 4	(tested to 2.2kV)	A
Surge Immunity	EN61000-4-5	Level 3	Common mode - 2.2kV Differential - 1.1kV	A
Conducted RF Immunity	EN61000-4-6	Level 3	(12V)	A
Power Frequency Magnetic Field	EN61000-4-8	Level 4	(30A/m)	A
Voltage Dips, Variations, Interruptions	EN61000-4-11	Class 3	Criteria B for 5 sec interruption	A
Voltage Fluctuations	EN61000-4-14	Class 3	For 100 - 240V Nominal	A

EMISSIONS EN61000-6-3:2001, EN60601-1-2:2001		
Radiated Electric Field	EN55011, EN55022	(as per CISPR.11/22) Class B, FCC47 part 15 subpart B see app note for details
Conducted Emissions	EN55011, EN55022	(as per CISPR.11/22) Class B, FCC47 part 15 subpart B
Conducted Harmonics	EN61000-3-2	Class A
Flicker	EN61000-3-3	Compliant - d _{max} only

ENVIRONMENT	
Temperature	0°C to 50°C operational, -40°C to 85°C storage (max 12 months). Full load, with either 'F' option fitted or 1.5m/s air blown from input to output (approximately 10CFM)
Derating	50°C to 65°C derate each output by 2.5% per °C
Low Temp Startup	-20°C
Humidity	5 - 95% RH non condensing
Shock	±3 x 30g shocks in each plane, total 18 shocks 30g shock = 11ms (+/-0.5msec), half sine Conforms to EN60068-2-27, EN60068-2-47, IEC68-2-27, IEC68-2-47, JIS C0041-1987. Conforms to MIL-STD-810E/F, Method 516.5, Pro I, IV, VI
Vibration	Single axis 10 - 500 Hz at 2g (sweep and endurance at resonance) in all 3 planes Conforms to EN60068-2-6, IEC68-2-6 Conforms to MIL-STD-810E, Method 514.4, Pro I, Cat 1,9
Altitude	3,000 metres operational
Pollution	Degree 2, Material group 3

SAFETY APPROVALS					
	Date	Amendments		Date	Amendments
EN 60950-1	2006		EN 61010-1	2001	
UL 60950-1	2007		IEC 61010-1*	2001	
CSA 22.2 No 60950-1	2003		IEC 60601-1*	1988	A1, A2
IEC 60950-1*	2005		EN 60601-1	1990	A1, A2, A13
CE Mark	LV Directive 2006/95/EC (EN60950-1)		UL 60601-1	2003	with revisions 2006
* CB certificate and Report available on request			Check with factory for status of approvals		



OUTLINE & CONNECTION DRAWINGS

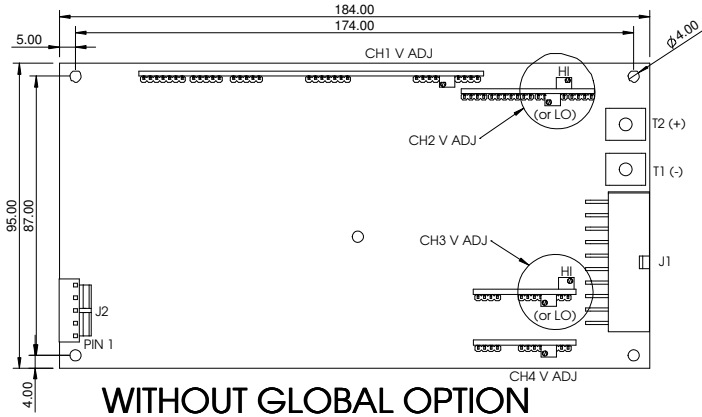

WITHOUT GLOBAL OPTION

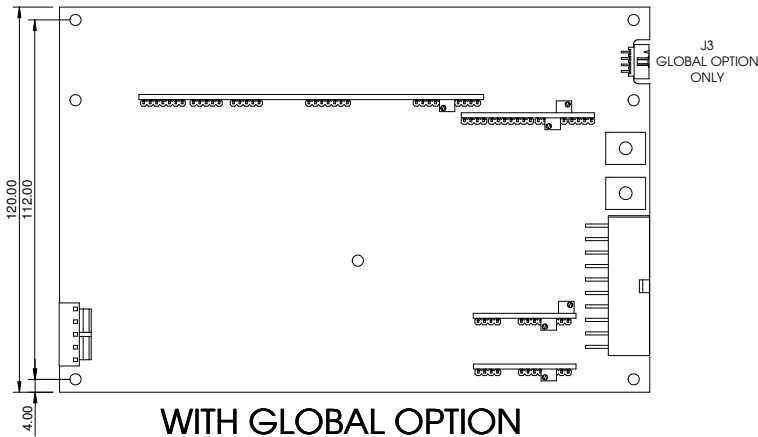

WITH GLOBAL OPTION

J2

PIN	CONNECTION
1	EARTH
2	NOT CONNECTED
3	LIVE
4	NOT CONNECTED
5	NEUTRAL

J1

PIN	CONNECTION	PIN	CONNECTION
11	0V COMMON	1	0V COMMON
12	0V COMMON	2	0V COMMON
13	CH2 +Ve	3	CH2 +Ve
14	CH2 +Ve	4	CH2 +Ve
15	+SENSE CH1	5	-SENSE CH1
16	+SENSE CH2	6	-SENSE CH2
17	CH1 GOOD	7	N/C
18	CH3 +Ve	8	CH3 +Ve
19	0V COMMON	9	0V COMMON
20	CH4 O/P	10	CH4 O/P

T1 & T2 (SEE TOP LEFT)

J3 (GLOBAL OPTION ONLY)

PIN	CONNECTION	PIN	CONNECTION
1	STANDBY -Ve	5	N/C
2	STANDBY +Ve	6	N/C
3	STANDBY -Ve	7	POWER GOOD
4	STANDBY +Ve	8	REM ON/OFF

MATING PARTS (MOLEX OR EQUIVALENT)

CONNECTOR	HOUSING	CRIMP PIN
J1	39-01-2205	44476-3112
J2	09-50-8051	08-52-0113
J3	51110-0860	50394
T1 & T2	N/A	TAG 19073-0165

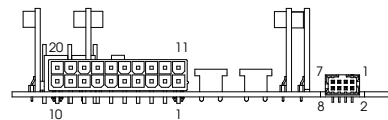
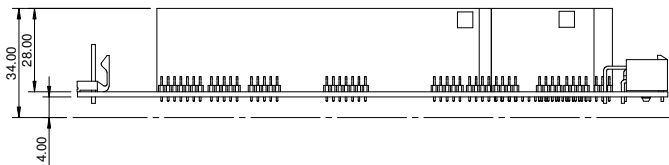

Notes 1. All customer fixings M3

2. Maximum Penetration 4.5mm

3. Maximum torque 0.9Nm

4. All tolerances +/-0.5mm



OUTLINE & CONNECTION DRAWINGS

OPEN FRAME

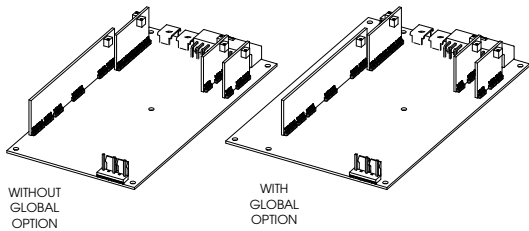

'U' CHANNEL
(COVER OPTIONAL)

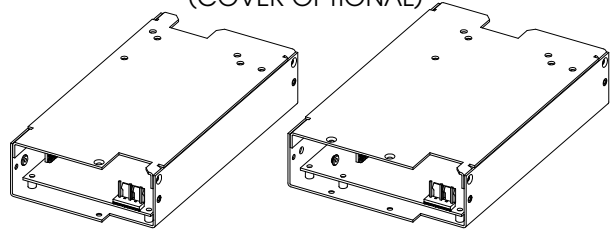

FAN OPTION

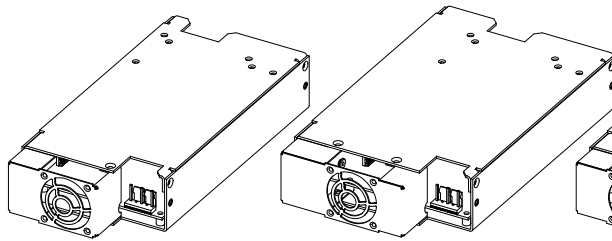

FAN+IEC OPTION

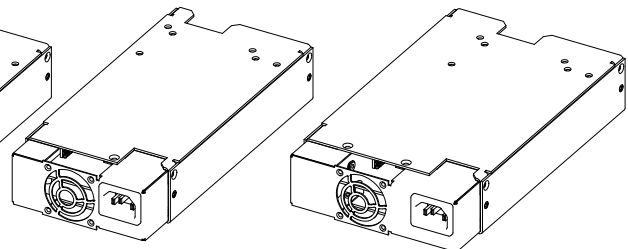

FAN+IEC OPTION

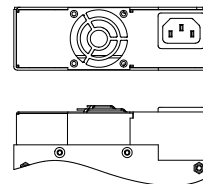
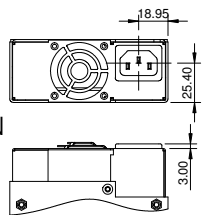

FAN OPTION

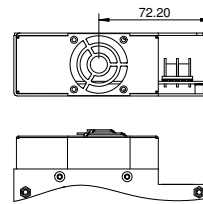
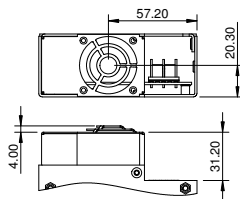

'U' CHANNEL

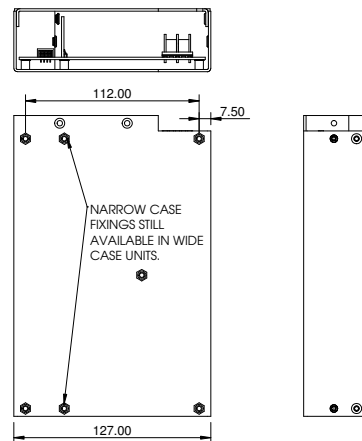
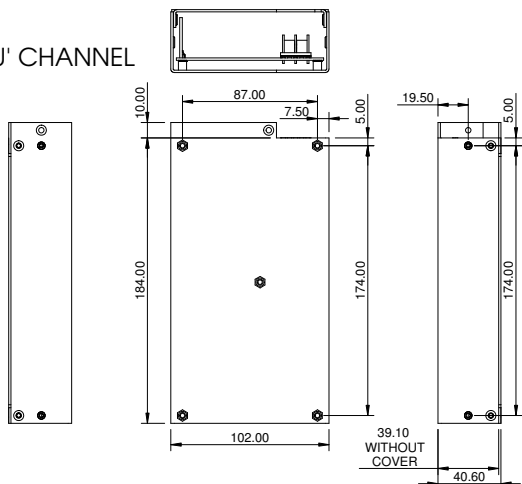

Notes 1. All customer fixings M3

2. Maximum Penetration 4.5mm

3. Maximum torque 0.9Nm

4. All tolerances +/-0.5mm



TDK-LAMBDA EMEA

www.emea-tdk-lambda.com



TDK-Lambda France SAS

ZAC des Delaches
BP 1077-Gometz-le-Chatel
91940 Les Ulis
France
Tel: +33 1 60 12 71 65
Fax: +33 1 60 12 71 66
france@fr.tdk-lambda.com
www.fr.tdk-lambda.com



Italy Sales Office
Via dei Lavoratori 128/130
20092 Cinisello Balsamo (MI)
Italy
Tel: +39 02 61 29 38 63
Fax: +39 02 61 29 09 00
info.italia@it.tdk-lambda.com
www.it.tdk-lambda.com



TDK-Lambda Germany GmbH

Karl-Bold-Strasse 40
77855 Achern
Germany
Tel: +49 7841 666 0
Fax: +49 7841 5000
info.germany@de.tdk-lambda.com
www.de.tdk-lambda.com



Austria Sales Office
Aredstrasse 22
2544 Leobersdorf
Austria
Tel: +43 2256 655 84
Fax: +43 2256 645 12
info.germany@de.tdk-lambda.com
www.de.tdk-lambda.com



TDK-Lambda UK Ltd.

Kingsley Avenue
Ilfracombe
Devon EX34 8ES
United Kingdom
Tel: +44 (0) 12 71 85 66 66
Fax: +44 (0) 12 71 86 48 94
powersolutions@uk.tdk-lambda.com
www.uk.tdk-lambda.com



Nemic Lambda Ltd.

Kibbutz
Givat Hashlosha 48800
Israel
Tel: +9 723 902 4333
Fax: +9 723 902 4777
info@nemic.co.il
www.nemic.co.il



Russia

Technical Support:
St Petersburg
Tel: +7 (812) 6580463
Sales:
Moscow
Tel: +7 (499) 7557732
info@tdk-lambda.ru
www.tdk-lambda.ru

LOCAL DISTRIBUTION

