

General Safety Instructions:

READ SAFETY INSTRUCTIONS

Servicing:

These products are not customer serviceable. TDK-Lambda UK LTD. and their authorised agents only are permitted to carry out repairs.

Critical Components:

These products are not authorised for use as critical components in nuclear control systems, life support systems or equipment for use in hazardous environments without the express written approval of the Managing Director of TDK-Lambda EMEA.

Product Usage:

These products are designed for use within a host equipment which restricts access to authorised competent personnel.

This product is a component power supply and is only to be installed by qualified persons within other equipment and must not be operated as a stand alone product.

This product is for sale to business to business customers and can be obtained via distribution channels. It is not intended for sale to end users.

This product is a component power supply and does not fall within the scope of the EMC directive. Compliance with the EMC directive must be considered in the final installation. Please contact your local TDK-Lambda office.

Environmental:

These products are IPX0, and therefore chemicals/solvents, cleaning agents and other liquids must not be used.

Environment:

This power supply is a switch mode power supply for use in applications within a Pollution Degree 2, overvoltage category II environment. Material Group IIIb PCB's are used within it.

Output Loading:

The output power taken from the power supply must not exceed the rating stated on the power supply label, except as stated in the product limitations in this handbook.

Input Parameters:

This product must be operated within the input parameters stated in the product limitations in this handbook.

End of Life Disposal:

The unit contains components that require special disposal. Make sure that the unit is properly disposed of at the end of its service life and in accordance with local regulations.



RISK OF ELECTRIC SHOCK

High Voltage Warning:

Dangerous voltages are present within the power supply. The professional installer must protect service personnel from inadvertent contact with these dangerous voltages in the end equipment.

WARNING: When installed in a Class I end equipment, this product must be reliably earthed and professionally installed.

The (+) or (-) output(s) can be earthed or left floating.

The unit cover(s)/chassis must not be made user accessible.

The mains input connector is not acceptable for use as field wiring terminals.

Do not use mounting screws, which penetrate the unit more than 4.5mm.

An internal fuse protects the unit and must not be replaced by the user. In case of internal defect, the unit must be returned to TDK-Lambda UK LTD or one of their authorised agents.

A suitable mechanical, electrical and fire enclosure must be provided by the end use equipment for mechanical, electric shock and fire hazard protection.

Energy Hazards:

CH1 output of this power supply is hazardous energy (240VA) and must not be user accessible in the end equipment into which it is installed.

The ventilation openings on these products must not be impeded. Ensure that there is at least 50mm spacing between any obstruction and the ventilation openings.

The unit may be mounted in any orientation except inverted (mounted on its top) or vertical with the airflow downwards. Customer air models only may be mounted vertical with the airflow downwards.

Allgemeine Sicherheitsvorschriften:

LESEN SIE DIE SICHERHEITSVORSCHRIFTEN

Wartung:

Diese Produkte können nicht durch den Kunden gewartet werden. Nur TDK-Lambda UK LTD. und deren zugelassene Vertriebshändler sind zur Durchführung von Reparaturen berechtigt.

Kritische Komponenten:

Diese Produkte sind nicht für die Verwendung als kritische Komponenten in nuklearen Kontrollsystemen, Lebenserhaltungssystemen oder Geräten in gefährlichen Umgebungen geeignet, sofern dies nicht ausdrücklich und in Schriftform durch den Geschäftsführer von TDK-Lambda EMEA genehmigt wurde.

Produktverwendung:

Diese Produkte sind zur Verwendung innerhalb von Host-Anlagen gedacht, die einen auf das Fachpersonal beschränkten Zugang haben.

Dieses Produkt ist eine Stromversorgungs-Komponente und sie darf nur von qualifiziertem Personal in andere Geräte eingebaut werden und sie darf NICHT als eigenständiges ("Stand-Alone") Gerät betrieben werden. Dieses Produkt ist für den Verkauf an Geschäftskunden entwickelt worden und es kann über Distributionskanäle bezogen werden.

Es ist NICHT für den Verkauf an Endkunden gedacht und konzipiert.

Dieses Produkt ist eine Stromversorgungsbaugruppe und sie fällt NICHT in den Bereich der EMV Direktive. Die Konformität mit der EMV Richtlinie muss in der finalen Gesamtinstallation betrachtet werden. Bitte kontaktieren Sie Ihr regionales TDK-Lambda Vertriebsbüro im Falle von Rückfragen.

Umwelt:

Diese Produkte sind IPX0, aus diesem Grund dürfen keine Chemikalien/Lösungsmittel, Reinigungsmittel und andere Flüssigkeiten verwendet werden.

Umgebung:

Dieses Netzteil ist ein Schaltnetzteil zur Verwendung in einer Umgebung mit einem Verschmutzungsgrad 2, Überspannungskategorie II. Materialgruppe IIIb mit darin verwendeten PCBs.

Ausgangsstrom:

Der Ausgangsstrom des Netzteiles darf die Leistung, die auf dem Label des Netzteiles vermerkt ist, nur dann überschreiten, wenn dies in den Produktgrenzen dieses Handbuches ausgezeichnet ist.

Eingangsparameter:

Dieses Produkt muss innerhalb der Eingangsparameter, die in den Produktgrenzen dieses Handbuches angegeben sind, betrieben werden.

Entsorgung am Ende der Betriebszeit:

Das Gerät enthält Komponenten die unter Sondermüll fallen. Das Gerät muss am Ende der Betriebszeit ordnungsgemäß und in Übereinstimmung mit den regionalen Bestimmungen entsorgt werden.



GEFAHR DURCH ELEKTRISCHEN SCHLAG!

Hochspannungswarnung:

Innerhalb des Netzteiles gibt es gefährliche Spannungen. Der Elektroinstallateur muss das Wartungspersonal vor versehentlichem Kontakt mit den gefährlichen Spannungen im Endgerät schützen.

WARNUNG! Falls Sie unser Netzgerät in eine Anwendung mit Schutzklasse 1 eingebaut haben, stellen Sie sicher, dass es fachgerecht installiert und zuverlässig geerdet ist.

Die (+) oder (-) Ausgänge können geerdet werden oder unangeschlossen bleiben.

Die Abdeckung des Gerätes/das Gehäuse darf für den Benutzer nicht zugänglich sein.

Der Haupteingangsanschluss ist nicht für die Verwendung als Feldverdrahtungsanschluss geeignet.

Verwenden Sie keine Befestigungsschrauben, die mehr als 4.5mm in das Gerät eindringen.

Eine interne Sicherung schützt das Gerät und darf durch den Benutzer nicht ausgetauscht werden. Im Fall von internen Defekten muss das Gerät an TDK-Lambda UK LTD oder einen der autorisierten Vertriebshändler zurückgeschickt werden.

Ein geeignetes mechanisches, elektrisches und brandgeschütztes Gehäuse muss als Schutz vor der Gefahr von mechanischen Risiken, Stromschlägen und Brandschutz in dem Endgerät vorgesehen werden.

Gefahren durch elektrische Energie:

Das wichtigste Ausgang, CH1 dieses Netzteil ist gefährlich energie (240VA) und dürfen in dem Endgerät, in das sie installiert werden, nicht für den Benutzer zugänglich sein.

Die Belüftungsöffnungen an diesem Produkt dürfen nicht blockiert werden. Achten Sie darauf, dass mindestens 50 mm Abstand zwischen Hindernissen und den Belüftungsöffnungen bleibt.

Das Gerät darf in jeder Position befestigt werden, mit Ausnahme über Kopf (umgekehrt) oder vertikal mit dem Luftstrom abwärts.

Consignes générales de sécurité:

LIRE LES CONSIGNES DE SECURITE

Entretien:

Ces produits ne peuvent pas être réparés par l'utilisateur. Seuls, TDK-Lambda UK LTD et ses agents agréés sont autorisés à effectuer des réparations.

Composants critiques:

Ces produits ne doivent pas être utilisés en tant que composants critiques dans des systèmes de commande nucléaire, dans des systèmes de sauvetage ou dans des équipements utilisés dans des environnements dangereux, sans l'autorisation écrite expresse du directeur général de TDK-Lambda EMEA.

Utilisation du produit:

Ces produits sont conçus pour être utilisés dans un équipement hôte dont l'accès n'est autorisé qu'aux personnes compétentes.

Ce produit est une alimentation considérée comme un composant devant être installé par des personnes qualifiées, dans un autre équipement. Il ne doit pas être utilisé en tant que produit fini.

Ce produit est destiné à la vente entre entreprises et peut être obtenu via des canaux de distribution.

Il n'est pas prévu à la vente pour les particuliers.

Ce produit est une alimentation considérée comme un composant, il ne relève pas du champ d'application de la directive CEM. Le respect de la directive CEM doit être pris en compte dans l'installation finale. Veuillez contacter votre bureau TDK-Lambda le plus proche.

Environnement:

Ces produits sont IPX0, et donc on ne doit pas utiliser des produits chimiques/solvants, des produits de nettoyage et d'autres liquides.

Environnement fonctionnel :

Cette alimentation fonctionne en mode commutation pour utilisation dans des applications fonctionnant dans un environnement avec Degré de Pollution 2 et catégorie de surtension II. Elle utilise des cartes des circuits imprimés (PCB) de Groupe IIIb.

Intensité soutirée:

L'intensité soutirée de l'alimentation ne doit pas dépasser l'intensité nominale marquée sur la plaque signalétique, sauf indications contraires dans les limitations du produit décrit dans ce manuel.

Paramètres d'entrée:

Ce produit doit être utilisé à l'intérieur des paramètres d'entrée indiqués dans les limitations du produit dans ce manuel.

Elimination en fin de vie:

L'alimentation contient des composants nécessitant des dispositions spéciales pour leur élimination. Vérifiez que cette alimentation est mise au rebut correctement en fin de vie utile et conformément aux réglementations locales en vigueur.



RISQUE DE CHOC ELECTRIQUE

Attention-Danger haute tension:

Des tensions dangereuses sont présentes dans l'alimentation. L'installateur doit protéger le personnel d'entretien contre un contact involontaire avec ces tensions dangereuses dans l'équipement final.

AVERTISSEMENT: Si ce produit est installé dans un équipement final de classe I, il doit être mis à la terre de manière fiable et installé par un professionnel averti.

Les sorties (+) ou (-) peuvent être raccordées à la terre ou laissées flottantes.

Le couvercle/châssis de l'alimentation ne doit pas être accessible à l'utilisateur.

Le connecteur d'entrée d'alimentation principale ne doit pas être utilisé comme borne de raccordement.

N'utilisez pas de vis pénétrant dans le module sur une profondeur supérieure à 4.5 mm.

Un fusible interne protège le module et ne doit pas être remplacé par l'utilisateur. En cas de défaut interne, le module doit être renvoyé à TDK-Lambda UK LTD ou l'un de ses agents agréés.

Une enceinte appropriée doit être prévue par l'utilisateur final pour assurer la protection contre les chocs mécaniques, les chocs électriques et l'incendie.

Energies dangereuses :

Le principal sortie, CH1 de cette alimentation est dangereuses énergie (240VA) et ne doivent pas être accessibles dans l'équipement final dans lequel elle est installée.

Les orifices de ventilation sur ces produits ne doivent pas être obstrués. Vérifiez qu'il y a un espace libre d'au moins 50 mm entre une obstruction et les orifices de ventilation.

Le module peut être monté suivant une orientation quelconque, sauf en position inversée (monté sur son sommet) ou en position verticale avec écoulement d'air descendant.

Norme generali di sicurezza:

SI PREGA DI LEGGERE LE NORME DI SICUREZZA

Manutenzione:

Il cliente non può eseguire alcuna manutenzione su questi prodotti. L'esecuzione delle eventuali riparazioni è consentita solo a TDK-Lambda UK LTD e ai suoi agenti autorizzati.

Componenti critici:

Non si autorizza l'uso di questi prodotti come componenti critici all'interno di sistemi di controllo nucleari, sistemi necessari alla sopravvivenza o apparecchiature destinate all'impiego in ambienti pericolosi, senza l'esplicita approvazione scritta dell'Amministratore Delegato di TDK-Lambda EMEA.

Uso dei prodotti:

Questi prodotti sono progettati per l'uso all'interno di un'apparecchiatura ospite che limiti l'accesso al solo personale competente e autorizzato.

Questo prodotto è da considerarsi come un alimentatore professionale componente e come tale deve essere installato da personale qualificato all'interno di altre apparecchiature e non può essere utilizzato come prodotto indipendente.

Questo prodotto non è inteso per la vendita al dettaglio o agli utilizzatori finali.

Questo alimentatore è da considerarsi come un componente e come tale non è assoggettato dagli scopi della direttiva EMC. Conformità alla direttiva EMC deve essere considerata nell'installazione finale di utilizzo. Gli uffici di TDK-Lambda Sas Succursale Italiana sono a vostra disposizione per ulteriori ragguagli.

Condizioni ambientali:

Questi prodotti sono classificati come IPX0, dunque non devono essere utilizzati sostanze chimiche/solventi, prodotti per la pulizia o liquidi di altra natura.

Ambiente:

Questo prodotto è un alimentatore a commutazione, destinato all'uso in applicazioni rientranti in ambienti con le seguenti caratteristiche: Livello inquinamento 2, Categoria sovratensione II. Questo prodotto contiene schede di circuiti stampati in materiali di Gruppo IIIb.

Carico in uscita:

La potenza in uscita ottenuta dall'alimentatore non deve superare la potenza nominale indicata sulla targhetta dell'alimentatore, fatto salvo dove indicato nei limiti per il prodotto specificati in questo manuale.

Parametri di alimentazione:

Questo prodotto deve essere utilizzato entro i parametri di alimentazione indicati nei limiti per il prodotto, specificati in questo manuale.

Smaltimento:

L'unità contiene componenti che richiedono procedure speciali di smaltimento. Accertarsi che l'unità venga smaltita in modo corretto al termine della vita utile e nel rispetto delle normative locali.



RISCHIO DI SCOSSA ELETTRICA

Avvertimento di alta tensione:

All'interno dell'alimentatore sono presenti tensioni pericolose. Gli installatori professionali devono proteggere il personale di manutenzione dal rischio di contatto accidentale con queste tensioni pericolose all'interno dell'apparecchiatura finale.

ATTENZIONE: Se installato in un'attrezzatura di classe I, questo prodotto deve essere collegato a terra in modo affidabile ed installato in modo professionale.

Le uscite (+) o (-) possono essere messa a terra o lasciate isolate.

I coperchi/il telaio dell'unità non devono essere accessibili da parte dell'utente.

Il connettore dell'alimentazione principale non può essere utilizzato come terminale di collegamento di campo.

Non utilizzare viti che penetrano nell'unità per più di 4.5 mm.

Un fusibile interno protegge l'unità e non deve essere sostituito dall'utente. Nell'eventualità di un difetto interno, restituire l'unità a TDK-Lambda UK LTD o a uno dei suoi agenti autorizzati.

L'apparecchiatura finale deve includere una recinzione meccanica, elettrica e antincendio per proteggere dai pericoli di natura meccanica, dalle scosse elettriche e dai pericoli di incendio.

Pericoli energetici:

L'uscita principale, CH1 di questo alimentatore è energia pericolosa (240VA) e non devono risultare accessibili da parte dell'utente all'interno dell'apparecchiatura finale in cui il prodotto viene installato.

Le griglie di ventilazione su questi prodotti non devono essere ostruite. Verificare che vi sia una distanza minima di 50 mm fra le griglie di ventilazione e qualsiasi eventuale ostruzione.

L'unità può essere installata in qualunque orientamento, ma non in posizione capovolta o in posizione verticale con il flusso dell'aria rivolto verso il basso.

Instrucciones generales de seguridad:

LEA LAS INSTRUCCIONES DE SEGURIDAD

Servicio:

Estos productos no pueden ser reparados por los clientes. TDK-Lambda UK LTD. y sus agentes autorizados son los únicos que pueden llevar a cabo las reparaciones.

Componentes fundamentales:

Estos productos no pueden ser utilizados como componentes fundamentales en sistemas de control nuclear, sistemas de soporte vital o equipos a utilizar en entornos peligrosos sin el consentimiento expreso por escrito del Director General de TDK-Lambda EMEA.

Uso de los productos:

Estos productos han sido diseñados para ser utilizados en un equipo central que restrinja el acceso al personal cualificado autorizado.

Este producto es una fuente de alimentación y sólo puede ser instalado por personal cualificado dentro de otros equipos y no debe ser tratado como un producto independiente. Este producto debe ser vendido entre empresas profesionales y solo puede obtenerse a través de los canales de distribución. No está destinado para la venta a usuarios finales

Este producto es una fuente de alimentación y no se ve afectada por la directiva EMC. El cumplimiento de la directiva EMC se debe considerar en la instalación final. Por favor, póngase en contacto con su oficina local de TDK - Lambda

Medioambiental:

Estos productos son IPX0 y, por tanto, no pueden utilizarse sustancias químicas/disolventes, agentes de limpieza ni otros líquidos.

Medio ambiente:

Esta fuente de alimentación es una fuente de alimentación de modo conmutado a utilizar en aplicaciones dentro de un entorno con un Grado de contaminación 2 y una Categoría de sobretensión II. En él se utilizan policloruros de bifenilo del Grupo de materiales IIIb.

Carga de salida:

La potencia de salida tomada de la fuente de alimentación no puede sobrepasar el valor nominal indicado en la etiqueta de la fuente de alimentación, excepto en los casos indicados en las limitaciones del producto en este manual.

Parámetros de entrada:

Este producto debe ser utilizado dentro de los parámetros de entrada indicados en las limitaciones del producto en este manual.

Desecho de la unidad:

La unidad contiene componentes que deben ser desechados de una manera especial. Asegúrese de desechar correctamente la unidad al final de su vida útil y conforme a las normas locales vigentes.



PELIGRO DE DESCARGAS ELÉCTRICAS

Advertencia de alta tensión:

En esta fuente de alimentación hay tensiones peligrosas. El instalador profesional debe proteger al personal de servicio contra cualquier contacto accidental con estas tensiones peligrosas en el equipo final.

ADVERTENCIA: La instalación de este producto en un equipo de clase I la deben llevar a cabo profesionales y el producto debe estar conectado a tierra.

La salida o salidas (+) o (-) pueden conectarse a tierra o se las puede dejar flotando.

Debe impedirse el acceso de los usuarios a la cubierta o cubiertas y al chasis de la unidad.

El conector de entrada de la red no es apto para ser utilizado a modo de bornes de cableado de campo.

No utilice tornillos de montaje susceptibles de penetrar en la unidad más de 4.5 mm.

Con estos productos se utilizan unos tornillos de puesta a tierra especiales que conectan la cubierta al chasis. No se deben quitar en ningún caso. En caso de quitarlos por error, hay que reemplazarlos por unos nuevos y comprobar la conexión a tierra del producto.

Un fusible interno protege la unidad y este no debe ser nunca reemplazado por el usuario. En caso de existir algún defecto interno, la unidad debe ser enviada a TDK-Lambda UK LTD o a uno de sus agentes autorizados.

El equipo de uso final debe constituir un recinto de protección mecánica, eléctrica y contra incendios de protección mecánica, contra descargas eléctricas y contra el peligro de incendios.

Peligros de energía:

La principal salida, CH1 de esta fuente de alimentación es la energía peligrosas (240VA) por lo que debe protegerse el equipo final en el que se instalen contra el acceso de los usuarios.

Las aberturas de ventilación de estos productos no deben obstruirse jamás. Asegúrese de que quede una separación de 50 mm por lo menos entre cualquier obstrucción y las aberturas de ventilación.

La unidad se puede montar en cualquier orientación excepto invertida (montada sobre su parte de arriba) o vertical con los orificios para el flujo de aire mirando hacia abajo.

Instruções gerais de segurança:

LEIA AS INSTRUÇÕES DE SEGURANÇA

Manutenção:

Estes produtos não são podem ser submetidos a manutenção por parte do cliente. Apenas a TDK-Lambda UK LTD e os seus agentes autorizados têm permissão para realizar reparações.

Componentes essenciais:

Não é autorizada a utilização destes produtos como componentes essenciais de sistemas de controlo nuclear, sistemas de suporte de vida ou equipamento para utilização em ambientes perigosos sem a expressa autorização por escrito do Director-Geral da TDK-Lambda EMEA.

Utilização do produto:

Estes produtos foram concebidos para utilização dentro de um equipamento de alojamento que apenas permita o acesso a pessoal qualificado autorizado.

Este produto é uma alimentação considerado com um componente para ser instalado por pessoas qualificadas, em outros equipamentos. Não deve ser usado como um produto acabado.

Este produto é destinado para venda entre as empresas e pode ser obtido através de canais de distribuição. Não se destina à venda aos particulares

Este produto é uma alimentação considerado com um componente, não é dentro do application âmbito da directiva CEM.

Conformidade com a directiva CEM devem ser considerados na instalação final.

Entre em contacto com seu escritório TDK-Lambda mais próximo.

Ambiental:

Estes produtos são IPX0 e, como tal, não se devem utilizar químicos/solventes, agentes de limpeza e outros líquidos.

Ambiente:

Esta fonte de alimentação é uma fonte de alimentação do modo de comutação para utilização em aplicações com um Nível de Poluição 2 e ambientes da categoria de sobretensão II. São utilizadas placas de circuitos impressos do grupo de materiais IIIb.

Carga de saída:

A potência de saída extraída da fonte de alimentação não deve exceder a classificação assinalada na etiqueta da fonte de alimentação, excepto quando indicado nas limitações do produto neste guia.

Parâmetros de entrada:

Este produto deve ser utilizado dentro dos parâmetros de entrada indicados nas limitações do produto neste guia.

Eliminação no fim de vida:

A unidade contém componentes que necessitam de procedimentos especiais de eliminação. Certifique-se de que a unidade é devidamente eliminada no fim da sua vida útil e que tal é feito em conformidade com os regulamentos locais.



RISCO DE CHOQUE ELÉCTRICO

Aviso de alta tensão:

Estão presentes tensões perigosas dentro da fonte de alimentação. O profissional que realizar a instalação deve proteger o pessoal de assistência contra contactos inadvertidos com estas tensões perigosas do equipamento final.

AVISO: Quando instalado num equipamento de Classe I, este produto deve ser ligado à terra de forma fiável e instalado por um profissional.

As saídas (+) e (-) podem ser ligadas à terra ou deixadas soltas.

O chassis/cobertura(s) da unidade não deve estar acessível ao utilizador.

O conector de entrada de alimentação não deve ser utilizado como terminal de cablagens no local.

Não utilize parafusos de montagem, uma vez que estes penetrarão na unidade em mais do que 4.5 mm.

Existe um fusível interno que protege a unidade e que não deve ser substituído pelo utilizador. Em caso de defeito interno, a unidade deve ser devolvida à TDK-Lambda UK LTD ou a um dos seus agentes autorizados.

O equipamento de utilização final deve fornecer um bastidor com protecção mecânica, eléctrica e contra incêndios adequada.

Perigos de energia:

As saída principal, CH1 desta fonte de alimentação é energy perigosas (240VA) e não devem estar acessíveis ao utilizador no equipamento final no qual estão instaladas.

As aberturas de ventilação destes produtos não devem ser obstruídas. Certifique-se de que existe um espaçamento de pelo menos 50 mm entre qualquer obstrução e as aberturas de ventilação.

A unidade pode ser instalada em qualquer posição, excepto invertida (montada sobre a parte superior), ou na posição vertical, com o fluxo de ar dirigindo-se para baixo.

Input Parameters

	AC and/or DC	
	60950-1	60601-1
Nominal input voltage range	100 - 240V AC or 133 - 318VDC*	100 - 240V AC
Maximum input voltage range	90 - 264V AC or 120 - 350VDC*	90 - 264V AC
Input frequency	45- 440Hz maximum or DC*	45-63Hz
Maximum input current	5A rms or 3.8A DC*	5A rms
Inrush current	<15A AT 25°C	<15A AT 25°C

*DC input ratings are for 60950-1, specific Non standards only.

All ratings apply for ambient temperatures up to 50°C. From 50 to 65°C the total output power and the output current ratings are both derated at 2.5% per deg C.

Special Instructions for medical applications of the following standards:

- IEC/EN 60601-1 2nd Edition +A1 + A2
- UL 60601-1, 1st Edition
- CAN/CSA-C22.2 No. 601.1-M90
- IEC/EN 60601-1 3rd Edition + A1
- ANSI/AAMI ES 60601-1
- CSA 22.2 No 60601-1

These products are designed for continuous operation within an overall enclosure, and must be mounted such that access to the mains terminals is restricted. See the appropriate standard listed above.

These products are NOT suitable for use in the presence of flammable anaesthetic mixtures with air or with oxygen, or with nitrous oxide.

For IEC/EN60601-1 2nd Edition + A1 + A2, UL60601 1st Edition, CAN/CSA-C22.2 No. 601-M90, the NV300 range provides the following levels of insulation: Basic insulation between input and outputs. All outputs to earth have functional insulation only.

For IEC/EN 60601-1 3rd Edition + A1, ANSI/AAMI ES 60601-1, CSA 22.2 No. 60601-1, the NV300 range provides reinforced insulation between input and outputs (2 MOOPs) for all products. All outputs to earth have functional insulation only.

Connect only apparatus complying with the standards listed above as appropriate to the signal ports.

All outputs are SELV and must not be connected in series.

These products are classed as ordinary equipment and are not protected against the ingress of water (IPX0).

Reference should be made to local regulations concerning the disposal of these products at the end of their useful life.

Where any part of this product is made accessible to the operator in the end use equipment, the operator must not touch this part and the patient at the same time.

These products have not been assessed to IEC/EN60601-1-2 (EMC) but EMC test data is available from TDK-Lambda UK Ltd.

WARNING: No modification of this product is allowed.

Except for permanently installed equipment, the overall equipment into which these products are installed must have double pole fusing on the input mains supply. The products themselves have single pole fusing in the live line only.

Environmental Specifications:

Description	Operation	Storage
Use	Indoor	-
Temperature	0 to 65°C(derating 2.5% above 50°C)	-40°C to +70°C
Humidity	5 to 95% RH, non-condensing	5 to 95% RH, non-condensing
Altitude	-200m to 4000m	-200m to 5000m
Pressure	70kPa to 106kPa	54kPa to 106kPa
Orientation	Customer air models: Horizontal with cover uppermost, PSU on its side and vertical	Fan models: Horizontal with cover uppermost, PSU on its side and vertical with input lowest
Material Group	IIIb	
Pollution Degree	2	

Overvoltage Category	II
Class	I
Weight	1 Kg max
IP Rating	IPX0

Level of Insulation:

Dielectric Strength testing is carried out as follows:

Primary mains circuit to earth - 2.25 - 2.35KVDC.

*Primary mains circuits to secondary: 4.25-4.35kVDC.

Outputs to earth are isolated to 200VDC.

*Important Note: This test is not possible with Y capacitors fitted to the unit as damage to these capacitors may occur. It is also necessary to short circuit the outputs together and to earth.

Safety Approvals:

UL60950-1 and CSA22.2 No.60950-1 - UL Recognised. C-UL for Canada.

UL/CSA 60601-1 - UL + C -UL approval

IEC / EN60950-1 - CE mark.

CE marking when applied to any NV300 product indicates compliance with the Low Voltage Directive in that it complies with EN60950-1 and with the ROHS Directive.

Fusing: Internal fuse (FS1): F6.3AH, 250V, 5x20mm

Symbols:



AC

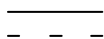

DC



EARTH

N – Neutral

L – Live



Danger, shock hazard



Caution refer to supplementary information

Note: All output voltages/variants may not be available as standard units, refer to datasheet for standard product range. These (and other variants) may be available as non-standard or custom units, please contact our sales team for details.

PRODUCTS COVERED

Unit Configuration Code:

NVx-abcde-f-g-ijk

- where:
- x = A3 for NV300
 - a = Number of Outputs: 1, 2, 3 or 4
 - b = Channel 1 Output Voltage†: 5, T or G
 - c = Channel 2 Output Voltage†: 1, 2, 2H, 3, 3H, 5, 5H, T, F or 0
 - d = Channel 3 Output Voltage†: T, F, TH, FH, G or 0
 - e = Channel 4 Output Voltage†: 3H, 5H, T, F, TH, FH, 0H (fan only channel 4 output) followed by P for positive output or 0
 - f = Global Option : N3 for 5V version with ATX compatibility, N4 for 12V version with ATX, N5 for 13.5V version ATX compatibility or nothing for no Global Option present
 - g = U for U chassis, C for U chassis and cover, F for U chassis and cover with fan, I for U chassis and cover with fan and IEC inlet or nothing for Open Frame
 - ijk = Three numbers from 0 to 9 which denotes various output voltages and currents within the specified ranges of each output for a particular unit or blank for standard output settings

† Table1: Output Voltage Cross Reference

Designation	Output Voltage
0	Omit output
A	1.5
1	1.8
B	2
2	2.7
3	3.3
5	5
7	7
T	12
F	15
G	24

All channels are adjustable except for Channel 4 and Global Options in accordance with the following table:

Output Channel	Voltage designation	Vout (V)	Adjustment Range (V)	Output Current (A)	Max Power (W)
CH1	5	5	5 - 5.5	40A	200
	T	12	12 - 13.2	25A	300
	G	24	24 - 28.5	12.5A	300
CH2 (CH1 5V)	1	1.8	0.9 - 2.5	15A	37.5
	2	2.7	2.5 - 3.8	15A	50
	3	3.3	2.5 - 3.8	15A	50
	3H	3.3	2.5 - 3.8	24A	80
CH2 (CH1 12V)	5	5	3.3 - 5.5	10A	50
	5H	5	3.3 - 5.5	16A	80
CH2 (CH1 24V)	5	5	5 - 5.5	8A	40
	5H	5	5 - 5.5	12.5A	62.5
	T	12	12 - 15.5	10A	150
CH3	F	15	12 - 15.5	10A	150
	T	12	12 - 15	5A	60
	F	15	12 - 15	5A	60
	TH	12	12 - 15	8A	96
CH4	FH	15	12 - 15	8A	96
	G	24	18 - 24.5	2.5A	60
	3H	+/-3.3	Fixed	2A	6.6
	5H	+/-5	Fixed	2A	10
	T	+/-12	Fixed	1A	12
	F	+/-15	Fixed	1A	15
CH4 (fan output)	TH	+/-12	Fixed	2A	24
	FH	+/-15	Fixed	2A	30
	OH	-	-	-	-
Global Option	N3	5 (ATX version)	Fixed	2A	10
	N4	12 (ATX version)	Fixed	1A	12
	N5	13.5 (ATX version)	Fixed	1A	13.5

Variations and limitations of use:

1. Maximum 300W power output. With 180Vac and greater input voltage, output power 300W plus global option (max 313.5W)
2. Channels 1 and 2 combined output currents must not exceed 40A.
3. Channel 1 with G output, 25V max with any channel 2 fitted.

Additional variations and limitations of use for fan version with 5V channel 1:

1. Output power de-rated 3W per volt from 100Vac to 90Vac (at 90Vac input, 270W output)
2. Unit with global option, high current channel 2 de-rated to 21A

3. Unit without global option, high current channel 2 de-rated to 19A
4. Unit without global option, low current channel 2 de-rated to 13A

Additional variations and limitations of use for all fan version:

1. Channel 4 - 3H, 5H, TH and FH max output current 1.5A.

The products listed in the following table are typical examples:

Model	CH1	CH2	CH3	CH4	Global Option
NVA3-453FFH	5V/40A	3.3V/15A	15V/5A	-15V/2A	-
NVA3-453HFHFH-N3	5V/40A	3.3V/24A	15V/8A	-15V/2A	5V/2A
NVA3-4GFGT-N5	24V/12.5A	15V/10A	24V/2.5A	-12V/1A	13.5V/1A

Custom models:

Model: NVA3 4G5HFHFH-N3-I (Y30006# where # can be any letter except A)
 Maximum outputs: CH1:24V, 6A. CH2:5V, 6A. CH3:15V, 3A. CH4:15V, 0.5A.
 Maximum ambient: 50°C
 Orientation: Horizontal
 Comments: Reverse air, compliant with 60950-1 only.

Model: NVA3 4G5HFHFH-N3-I (Y30006A)
 Maximum outputs: CH1:24V, 6A. CH2:5V, 6A. CH3:15V, 3A. CH4:15V, 0.5A.
 Maximum ambient: 40°C
 Orientation: Horizontal
 Comments: Reverse air, 8.2Vdc fixed speed fan, compliant with 60950-1 only.

Customer Air Cooling (option C, U and open frame):

The following method must be used for determining the safe operation of PSUs.

The components listed in the following table must not exceed the temperatures given. To determine the component temperatures the heating tests must be conducted in accordance with the requirements of the safety standard in question.

Test requirements include: PSU to be fitted in its end-use equipment and operated under the most adverse conditions permitted in the end-use equipment handbook/specification and which will result in the highest temperatures in the PSU. To determine the most adverse conditions consideration should be given to the end use equipment maximum operating ambient, the PSU loading and input voltage, ventilation, end use equipment orientation, the position of doors & covers, etc. Temperatures should be monitored using type K fine wire thermocouples (secured with cyanoacrylate adhesive, or similar) placed on the hottest part of the component (out of any direct airflow) and the equipment should be run until all temperatures have stabilised.

Minimum 0.5m/s airflow for customer air cooling.

Circuit Ref.	Description	Max. Temperature (°C)
L4, L2	Common mode choke winding	130 (140)
L6	Series mode choke winding	130 (140)
C2, C3, C16	X capacitors	100
C12, C13	Capacitor	105
L1	Boost choke winding	130
C1	Electrolytic capacitor	70 (105)
TX2, TX4	Transformer winding	130
TX701	Global option transformer	130
L3	Choke winding (when fitted)	130
L7	Channel 1 Output choke	125
XL401	Channel 2 Output choke (SMA 2)	125
XL501	Channel 3 Output choke (SMA 3)	125
XL601	Channel 4 Output choke (SMA 4)	125
XQ101	Boost FET (IMS board)	115
Q2, Q4	Ch1 FET and Ch3 FET	115
XQ413	Ch2 FET (SMA 2, O/Ps 3H, 5H, T and F)	115
XV406	Ch2 FET (SMA 2, O/Ps 1, 2, 3 and 5)	115
XV504	Ch3 FET (SMA 3, O/Ps T, F, TH and FH)	115
XQ501	Ch3 FET (SMA 3, O/P G)	115
XU601	Ch4 IC (SMA 4)	115
IC1	Ch4 Voltage regulator (1A Ch4 output)	110
Various	All other electrolytic capacitors	90 (105)

See components to be monitored diagrams below.

Higher temperatures limits (in brackets) may be used but product life may be reduced.

Input Connections:

Molex 3 pin header 7A/250V MAX.

IEC 60320 inlet

Output Connections:

Maximum Torque Settings for Output Screw Terminals: M3 – 0.5 – 0.6Nm

M4 – 1.1 – 1.3Nm

Protective Earth Conductor

The Protective Earth conductor has been tested at 40A for 2 minutes through the J2 input connector. Additional testing may be required in the end use equipment.

Earthing

For uncased models without the global option, Y1 to Y5 must be connected to Protective Earth. For models with the global option, Y1 to Y7 must be connected to Protective Earth in the end use equipment.

Capacitive Loads

Outputs on NV300 are designed for use with capacitive loads up to the value shown in the table below.

Applications where a discharged capacitor is switched onto the power supply output create additional loading for which a non standard product may be required.

Consult factory for details.

Capacitive loading table

Output Voltage	CH1	CH2	CH2H ²	CH3	CH3H ²	CH4H ²
Max Capacitive load (µF/Amp) ¹	1000 µF/A	1000 µF/A	1000 µF/A	100 µF/A	1000 µF/A	1000 µF/A

Note 1 –To calculate the allowed capacitance multiply the figure in the table above by the maximum allowed current rating of the output.

Note 2. The H applies to outputs identified with an H e.g. 5H is a 5V high current variant.

COMPONENTS TO BE MONITORED

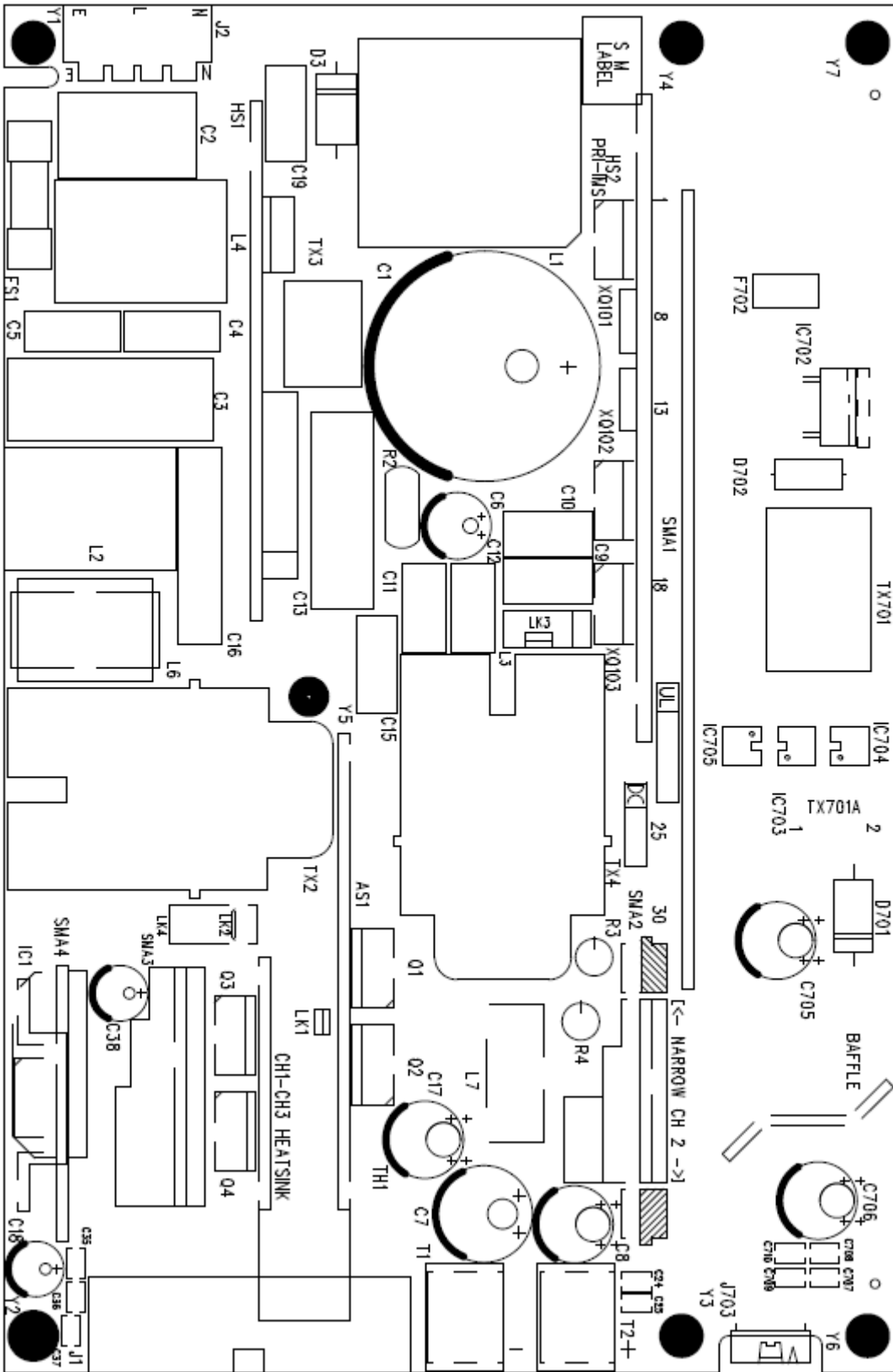

Base board (Wide)

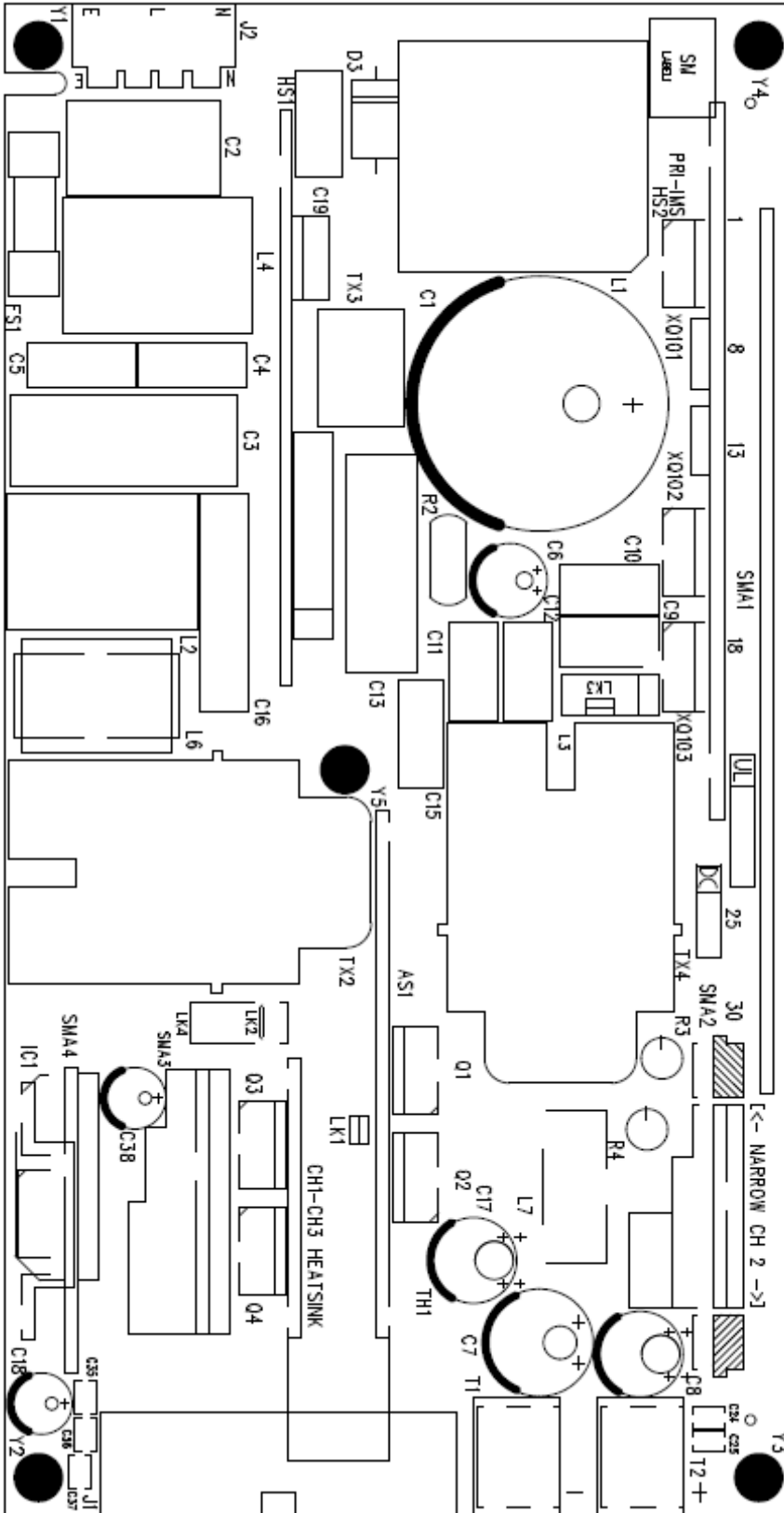

Base board (Narrow)

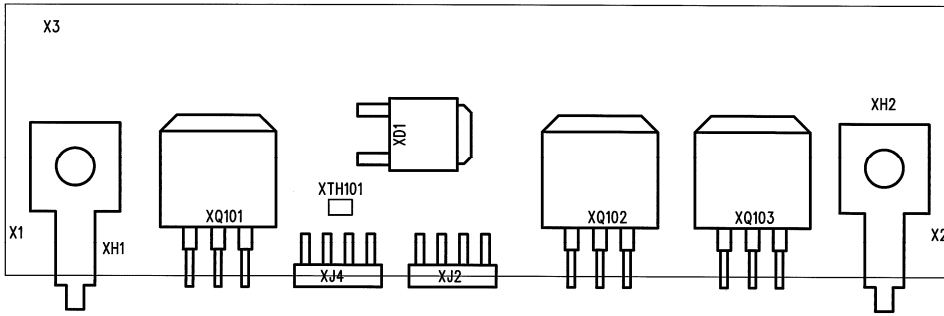

Primary IMS board

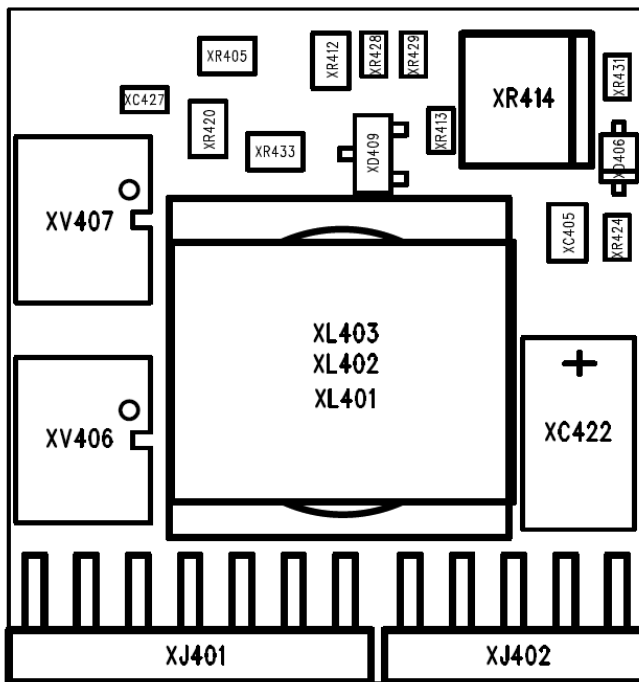

SMA Ch2 O/Ps T3, T5, G3, G5

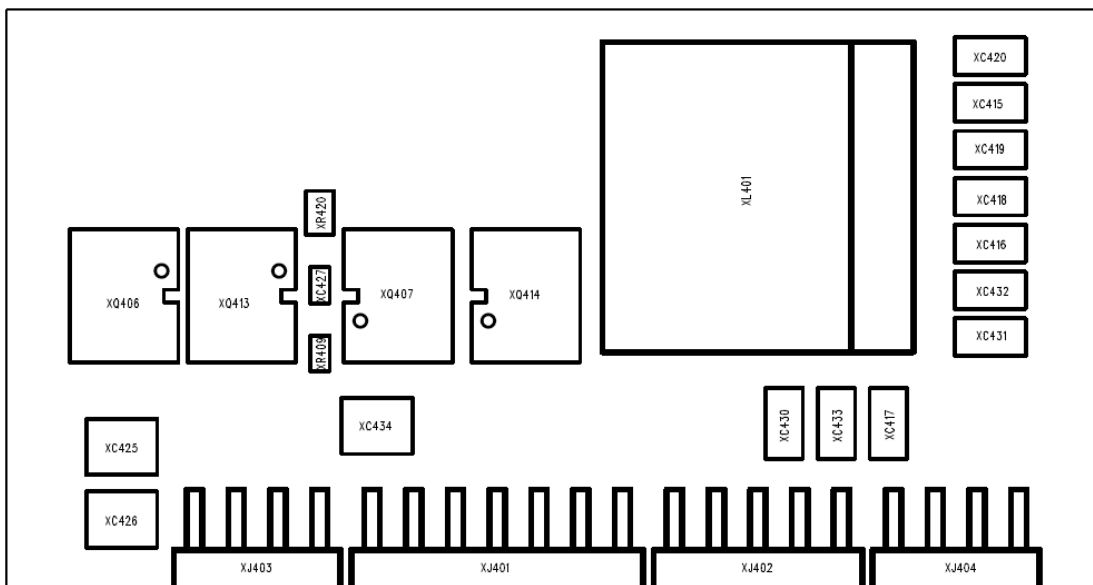

SMA Ch2 O/Ps T3H, T5H, G3H, G5H, GT, GF

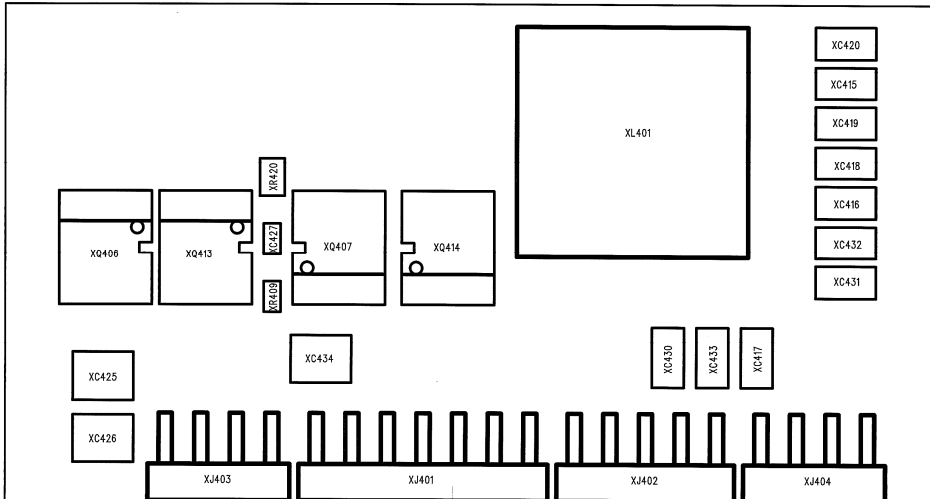

SMA Ch2 O/Ps 5 & 3H

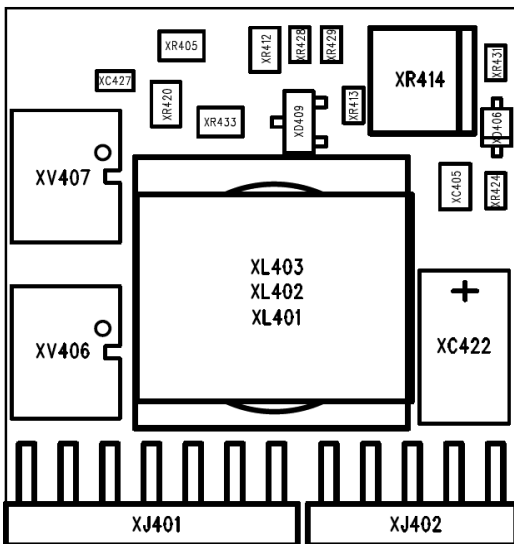

SMA 2 boards (Ch2 O/Ps 1, 2, 3 and 5)

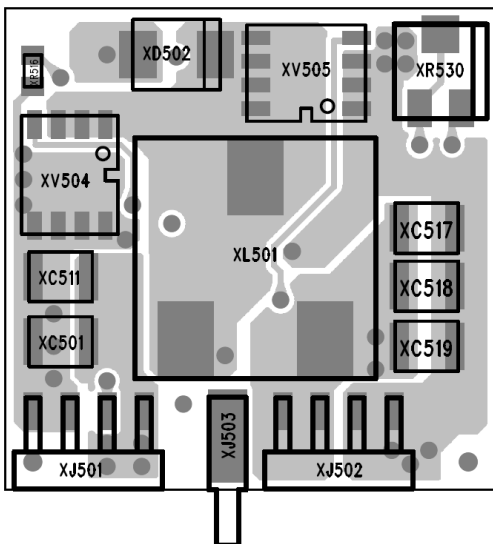

SMA 3 board (Ch3, O/Ps T, F and G)

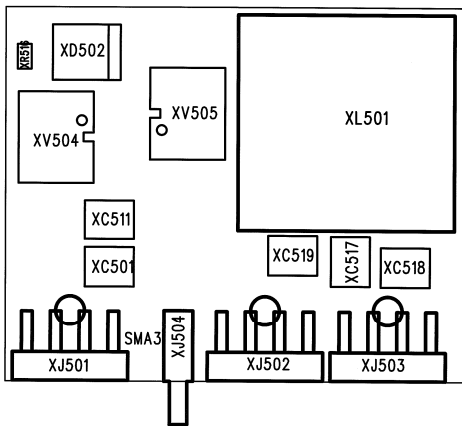

SMA 3 board (Ch3, O/Ps TH and FH)

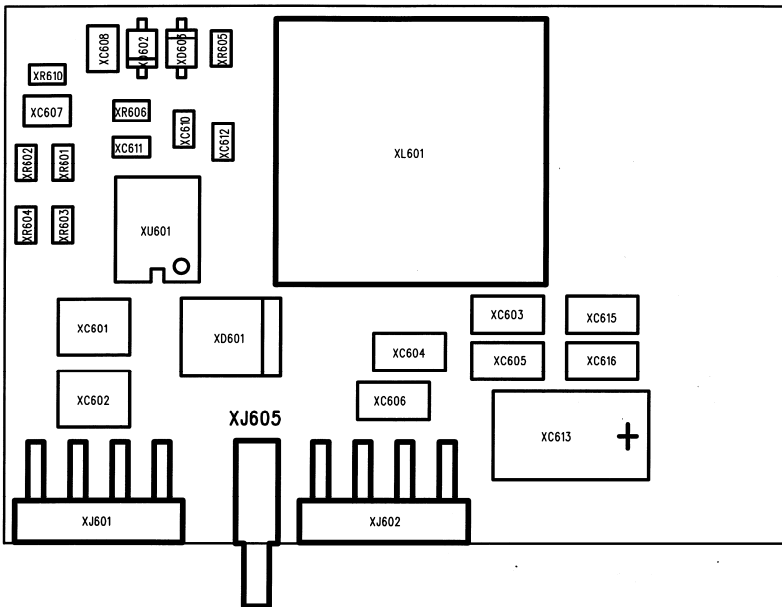

SMA 4 board (Ch4)

OUTLINE & CONNECTION DRAWINGS

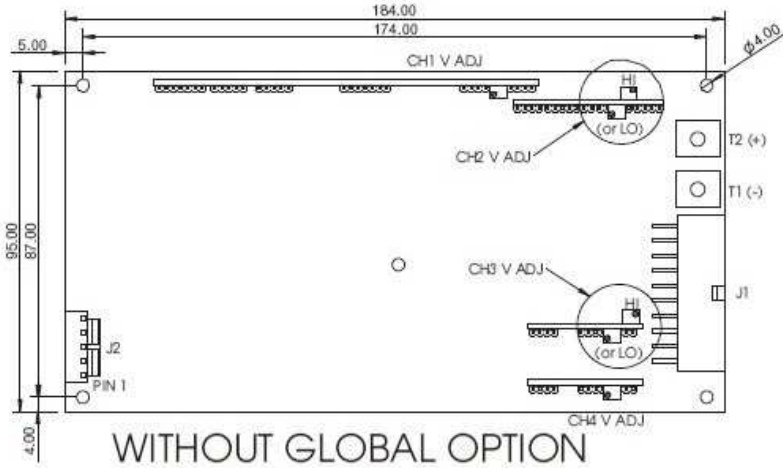

WITHOUT GLOBAL OPTION

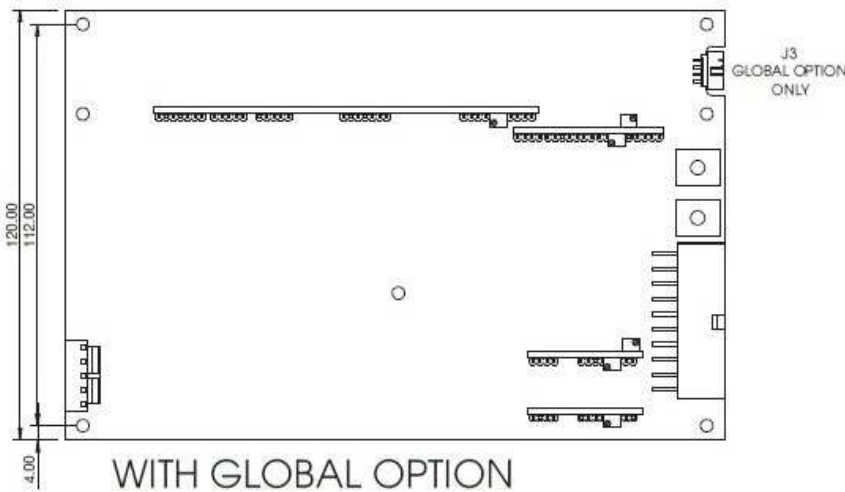

WITH GLOBAL OPTION

J2

PIN	CONNECTION
1	EARTH
2	NOT CONNECTED
3	LIVE
4	NOT CONNECTED
5	NEUTRAL

J1

PIN	CONNECTION	PIN	CONNECTION
11	0V COMMON	1	0V COMMON
12	0V COMMON	2	0V COMMON
13	CH2 +Ve	3	CH2 +Ve
14	CH2 +Ve	4	CH2 +Ve
15	+SENSE CH1	5	-SENSE CH1
16	+SENSE CH2	6	-SENSE CH2
17	CH1 GOOD	7	N/C
18	CH3 +Ve	8	CH3 +Ve
19	0V COMMON	9	0V COMMON
20	CH4 O/P	10	CH4 O/P

T1 & T2 (SEE TOP LEFT)

J3 (GLOBAL OPTION ONLY)

PIN	CONNECTION	PIN	CONNECTION
1	STANDBY -Ve	5	N/C
2	STANDBY +Ve	6	N/C
3	STANDBY -Ve	7	POWER GOOD
4	STANDBY +Ve	8	REM ON/OFF

MATING PARTS (MOLEX OR EQUIVALENT)

CONNECTOR	HOUSING	CRIMP PIN
J1	39-01-2205	45750-3-112
J2	09-50-8051	08-52-0-113
J3	51110-0860	50394
T1 & T2	N/A	TAG 19073-0-165

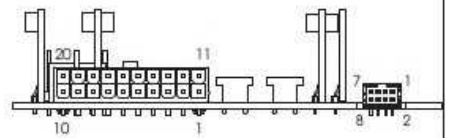
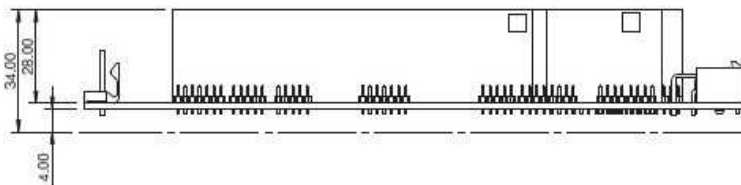

Notes

1. All customer fixings are M3
2. Maximum thread penetration 4.5mm
3. Maximum torque 0.5 to 0.6Nm
4. All tolerances +/-0.5mm

Input and output connectors are not included with the product. They are available from TDK-Lambda

1 off input connector and 3 crimps part number is 94910.
1 off output connector and 20 crimps part number is 94912.

Casing options

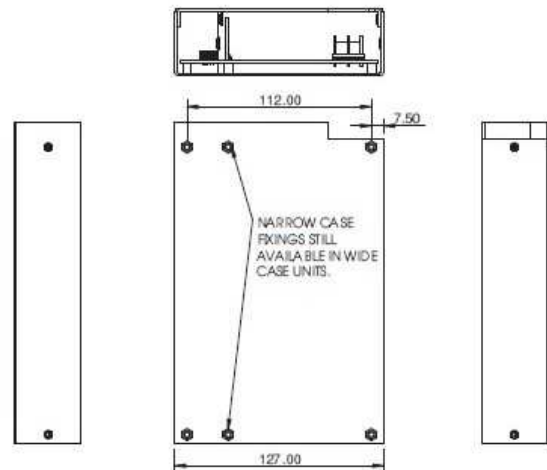
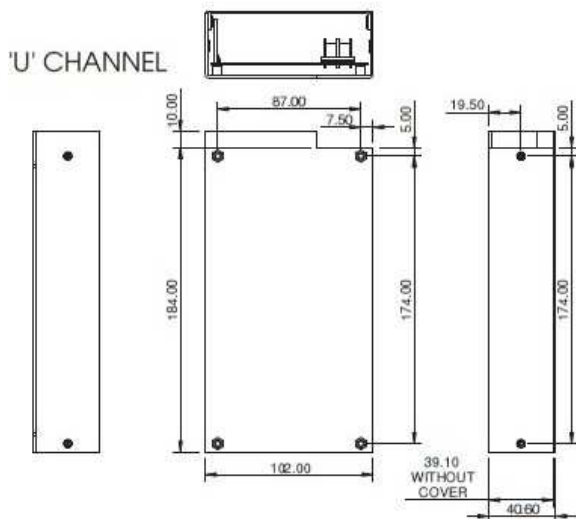
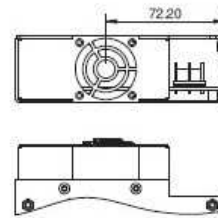
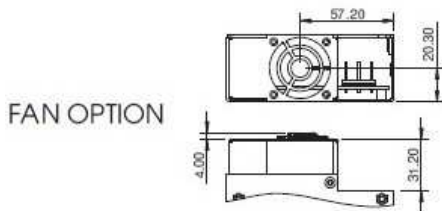
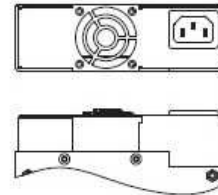
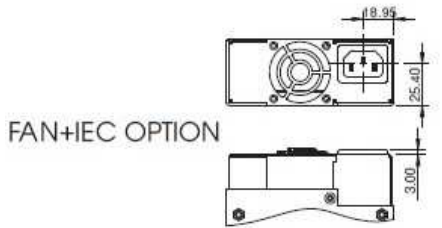
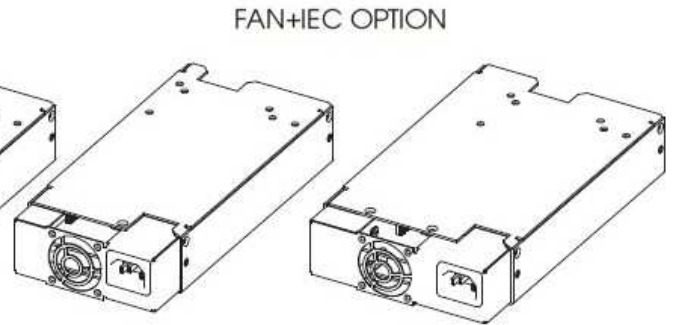
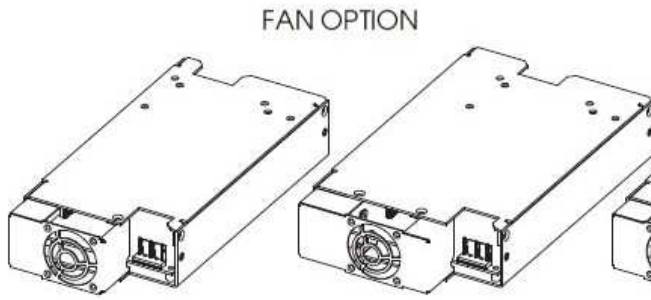
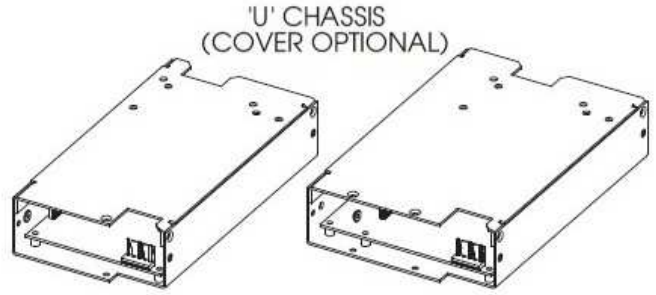
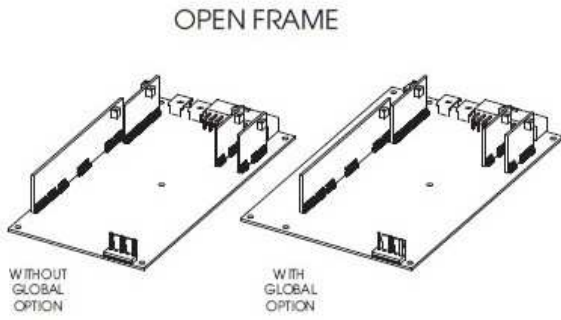

TDK-Lambda

TDK-Lambda UK Ltd
Kingsley Avenue, Ilfracombe
Devon, EX34 8ES
Telephone - Sales and Service +44 (0)1271 856666
Head Office and Works +44 (0)1271 856600
Facsimile +44 (0)1271 864894
WEBSITE: www.uk.tdk-lambda.com