



1000W to 1500W Single Output General Purpose Power Supplies

Features	Benefits
• Enclosed Compact Construction	• Easy Installation
• Class B Conducted & Radiated EMI	• Easier System Compliance
• SEMI F47 Line Dips	• Better System Integrity
• 7 Year Warranty	• Lower Cost of Ownership



Specification		RWS1000B	RWS1500B
AC Input Voltage range (1)	VAC	85 - 265VAC (47 - 63Hz)	
DC Input Voltage range*	VDC	120 - 340VDC*	
Inrush Current (100 / 200VAC)	A	60 / 60A	
Power Factor (100 / 200VAC)	-	Meets EN61000-3-2 (0.98 / 0.95)	
Input Current (100/200VAC) (Typ)	A	13 / 7A	19 / 10A
Temperature Coefficient	%/°C	<0.02%/°C	
Regulation	-	See Model Selector	
Overcurrent Protection	-	>105%, Constant Current Style. After 5s unit will shutdown	
Overvoltage Protection	V	120-145% (115-125% for 48V), Cycle AC line to reset	
Hold Up Time (Typ at 100% load)	ms	20ms	
Leakage Current (max)	mA	<1.2mA	
Standby Voltage	-	5V 1A (always on). See options table	
Remote Sense	-	Yes	
Remote On/Off	-	See options table. Apply external voltage to enable output	
DC Good, Fan Alarm	-	See options table	
Parallel Operation	-	See options table	
Series Operation	-	Yes	
Operating Temperature	°C	-20 to +60°C, derate linearly to 60% load from 50 to 60°C. Reverse air (/RF): -20 to +70°C, derate linearly to 50% load from 50 to +70°C	
Storage Temperature	°C	-30 to +75°C	
Operating Humidity (non condensing)	%RH	20 - 90%RH	
Storage Humidity (non condensing)	%RH	10 - 90%RH	
Cooling	-	Internal Fan, air intake from input/output terminals	
Withstand Voltage	VAC	Input to Ground 2kVAC, Input to Output 4kVAC, Output to Ground 1.5kVAC for 1 min.	
Isolation Resistance	MΩ	>100MΩ at 25°C & 70%RH, Output to Ground 500VDC	
Vibration (non operating)	-	10 - 55Hz: 19.6m/s ² (sweep 1 min) X, Y, Z for 1 hour	
Shock	-	< 196.1 m/s ²	
Safety Agency Certifications	-	IEC/UL/CSA/EN60950-1, IEC/UL/CSA/EN62368-1, CE Mark	
Line Dips	-	SEMI-F47 (200VAC input)	
Conducted & Radiated EMI	-	EN55011 / EN55032-B, FCC Class B, VCCI-B	
Immunity	-	IEC61000-4-2, -3, -4, -5, -6, -8, -11, IEC61000-6-2	
Weight (Typ)	g	2,000g	3,000g
Size (WxHxD)	mm	127 x 63 x 198mm	127 x 63 x 261mm
MTBF - Telcordia SR-332 issue 3**	hours	1,834,313	1,222,361
Warranty	yrs	7	

Notes: *Safety certified for AC input only **24V output model, 25°C ambient, full load, 230VAC input
(1) Derate linearly to 80% load from 90 to 85VAC input

Model Selector								
Model	Voltage (V)	Adjust Range (V)	Max Current (A)	Max Output Power (w)	Load Reg (mV)	Line Reg (mV)	Ripple Noise (mV)	Efficiency (typ) % 115/230VAC
RWS1000B-12	12	10.2-13.8	84	1008	96	48	150	82 / 85
RWS1000B-12/S	12	10.2-13.8	84	1008	96	48	150	82 / 85
RWS1500B-12	12	10.2-13.8	125	1500	96	48	150	81 / 85
RWS1500B-12/S	12	10.2-14.4	125	1500	96	48	150	81 / 85
RWS1000B-15	15	12.8-17.2	67	1005	120	60	150	82 / 85
RWS1000B-15/S	15	12.8-17.2	67	1005	120	60	150	82 / 85
RWS1500B-15	15	12.8-17.2	100	1500	120	60	150	82 / 85
RWS1500B-15/S	15	12.8-18.0	100	1500	120	60	150	82 / 85
RWS1000B-24	24	20.4-27.6	42	1008	144	96	180	85 / 88
RWS1000B-24/S	24	20.4-28.8	42	1008	144	96	180	85 / 88
RWS1500B-24	24	20.4-27.6	63	1512	144	96	180	85 / 88
RWS1500B-24/S	24	20.4-28.8	63	1512	144	96	180	85 / 88
RWS1000B-36	36	30.6-41.4	28	1008	216	144	250	85 / 88
RWS1000B-36/S	36	30.6-41.4	28	1008	216	144	250	85 / 88
RWS1500B-36	36	30.6-41.4	42	1512	216	144	250	85 / 88
RWS1500B-36/S	36	30.6-43.2	42	1512	216	144	250	85 / 88
RWS1000B-48	48	40.8-52.8	21	1008	288	192	300	85 / 88
RWS1000B-48/S	48	40.8-57.6	21	1008	288	192	300	85 / 88
RWS1500B-48	48	40.8-52.8	32	1536	288	192	300	85 / 88
RWS1500B-48/S	48	40.8-57.6	32	1536	288	192	300	85 / 88

Options	
Suffix	Description
/CO2	Double Sided Board Coating
/FO	Parallel Operation, DC Good and Fan Alarm Signals
/R	Remote On/Off
/RF	Reverse Fan (Air exits over input/output terminals)
/RFO	Remote On/Off, Parallel Operation, DC Good and Fan Alarm Signals
/S	5V 1A Standby Voltage and Remote On/Off

Combinations of the listed options are possible.
Contact your local sales office for availability, minimum order quantities may apply.

RWS 1000B Outline Drawing

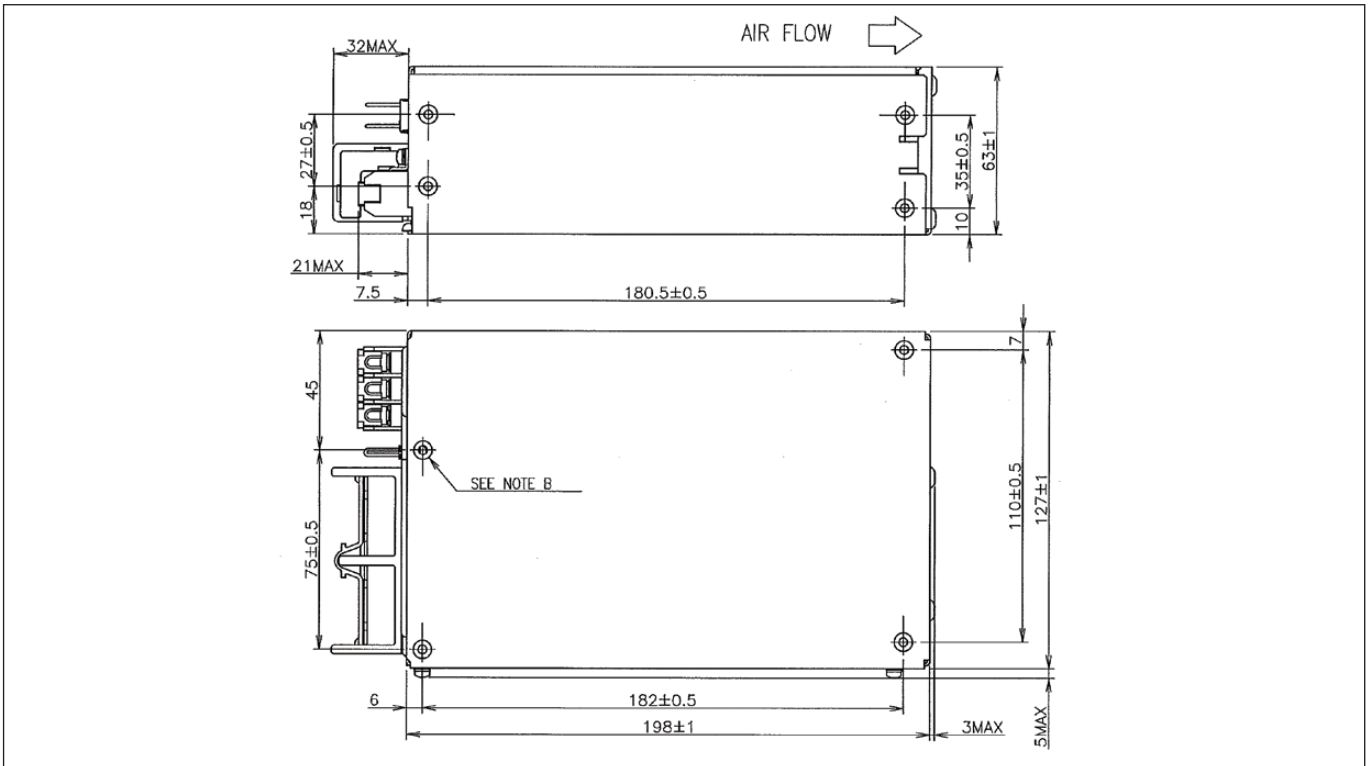

RWS 1500B Outline Drawing

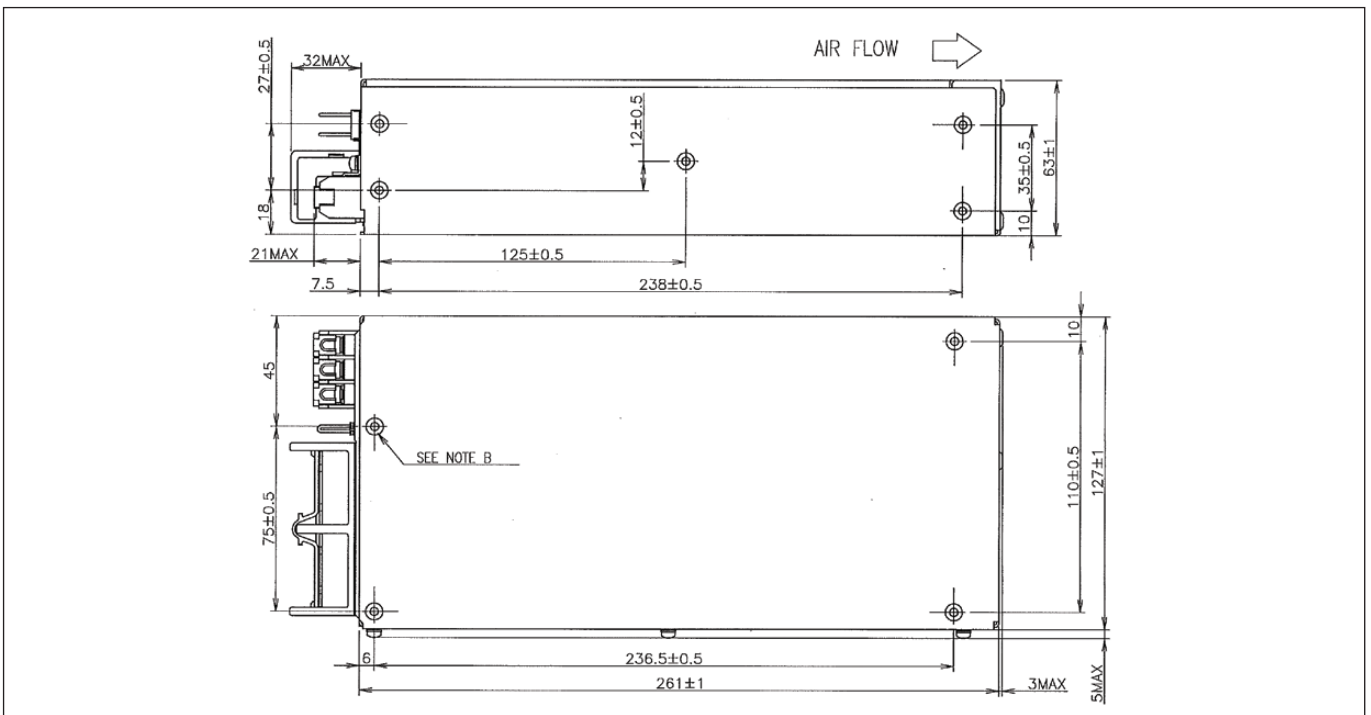



TDK-Lambda France SAS

3 Avenue du Canada
Parc Technopolis
Bâtiment Sigma
91940 les Ulis
France
Tel: +33 1 60 12 71 65
Fax: +33 1 60 12 71 66
france@fr.tdk-lambda.com
www.emea.lambda.tdk.com/fr



Italy Sales Office

Via Giacomo Matteotti 62
20092 Cinisello Balsamo (MI)
Italy
Tel: +39 02 61 29 38 63
Fax: +39 02 61 29 09 00
info.italia@it.tdk-lambda.com
www.emea.lambda.tdk.com/it



Netherlands

info@nl.tdk-lambda.com
www.emea.lambda.tdk.com/nl



TDK-Lambda Germany GmbH

Karl-Bold-Strasse 40
77855 Achern
Germany
Tel: +49 7841 666 0
Fax: +49 7841 5000
info.germany@de.tdk-lambda.com
www.emea.lambda.tdk.com/de



Austria Sales Office

Aredstrasse 22
2544 Leobersdorf
Austria
Tel: +43 2256 655 84
Fax: +43 2256 645 12
info@at.tdk-lambda.com
www.emea.lambda.tdk.com/at



Switzerland Sales Office

Eichtalstrasse 55
8634 Hombrechtikon
Switzerland
Tel: +41 44 850 53 53
Fax: +41 44 850 53 50
info@ch.tdk-lambda.com
www.emea.lambda.tdk.com/ch



Nordic Sales Office

Haderslevvej 36B
DK-6000 Kolding
Denmark
Tel: +45 8853 8086
info@dk.tdk-lambda.com
www.emea.lambda.tdk.com/dk



TDK-Lambda UK Ltd.

Kingsley Avenue
Ilfracombe
Devon EX34 8ES
United Kingdom
Tel: +44 (0) 12 71 85 66 66
Fax: +44 (0) 12 71 86 48 94
info@uk.tdk-lambda.com
www.emea.lambda.tdk.com/uk



TDK-Lambda Ltd.

1 Alexander Yanai
Segula
Petah-Tikva
Israel
Tel: +9 723 902 4333
Fax: +9 723 902 4777
info@tdk-lambda.co.il
www.emea.lambda.tdk.com/il



C.I.S.

Commercial Support:
Tel: +7 (495) 665 2627
Technical Support:
Tel: +7 (812) 658 0463
info@tdk-lambda.ru
www.emea.lambda.tdk.com/ru

Local Distribution

