

***CUS150M***

**AC/DC Power Supply Series**

***APPLICATION NOTE***

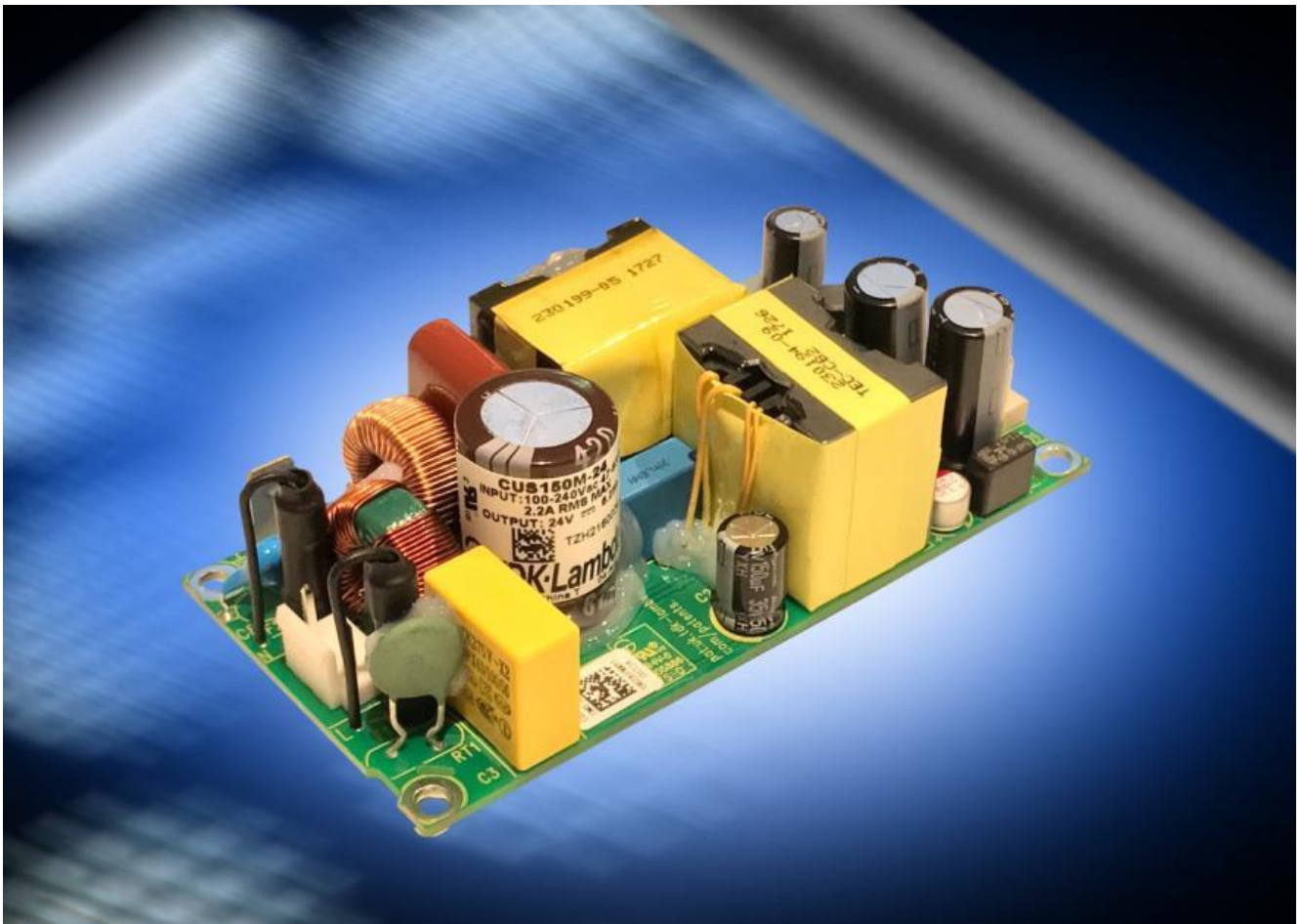

**Contents**

- Contents ..... 2
- 1. INPUT ..... 3
  - AC INPUT LINE REQUIREMENTS ..... 3
- 2. DC OUTPUT ..... 3
  - OUTPUT VOLTAGE ADJUSTMENT ..... 3
- 3. CONNECTIONS ..... 3
- 4. GENERAL OPERATION ..... 7
  - EFFICIENCY ..... 7
  - NO LOAD OPERATION ..... 8
  - CAPACITIVE LOAD OPERATION ..... 8
  - SERIES CONNECTION ..... 8
  - PARALLEL CONNECTION ..... 8
  - OUTPUT CHARACTERISTICS ..... 9
  - RIPPLE AND NOISE ..... 9
  - TRANSIENT RESPONSE PERFORMANCE ..... 9
  - OUTPUT TIMING ..... 10
  - OVERSHOOT AT TURN-ON AND TURN-OFF ..... 10
  - OUTPUT PROTECTION ..... 11
- 5. COOLING REQUIREMENTS ..... 12
  - CONVECTION AND CONDUCTION COOLING ..... 12
  - FORCED AIR COOLING ..... 14
- 6. RELIABILITY ..... 15
  - ELECTROLYTIC CAPACITOR LIFETIMES ..... 15
- 7. ELECTROMAGNETIC COMPATIBILITY ..... 17
  - INSTALLATION FOR OPTIMUM EMC PERFORMANCE ..... 17
- 8. WEIGHT ..... 18

## 1. INPUT

### AC INPUT LINE REQUIREMENTS

See datasheet for specification of input line requirements (including Input voltage range, Input frequency, Input harmonics, Input current and leakage current)

The power supply will automatically recover from AC power loss and start-up with maximum loading at 85VAC.

Repetitive ON/OFF cycling of the AC input voltage will not damage the power supply or cause the input fuses / fuse (/E option) to blow.

- Input Fuses

Two internal fuses are fitted, one in each AC line. These fuses are not user serviceable. Fuses are rated 3.15A; 250 Vac.

With the /E option, one internal fuse is fitted in the Line (L) connection.

- Input Undervoltage

The power supply is protected against the application of an input voltage below the minimum specified so that it shall not cause damage to the power supply. However if under voltage conditions persist for a long time the power supply may be overheated. Note that the power supply doesn't have over-temperature protection.

The typical turn on voltage is 71VAC, typical turn off voltage is 65VAC. (Full load, 25°C ambient)

## 2. DC OUTPUT

### OUTPUT VOLTAGE ADJUSTMENT

The output voltage is factory set to the standard model output voltage value and is not user adjustable. Non-standard voltages can be supplied within the allowable range on request.

| Model         | CUS150M-12 | CUS150M-15 | CUS150M-18 | CUS150M-24 | CUS150M-28 | CUS150M-36 | CUS150M-48 |
|---------------|------------|------------|------------|------------|------------|------------|------------|
| Voltage Range | 12 - 13.2  | 15 - 16.5  | 18 - 19.8  | 24 - 26.4  | 28 - 30.8  | 36 - 39.6  | 48 - 50    |

There are deviations to the specifications when the output voltage is factory set above the standard value. Hold up time is linearly reduced with increasing output voltage from standard nominal. Maximum reduction is 20% when output voltage is increased to +10%.

Voltage dips and interruptions performance is also affected. Performance criteria A is achieved with output power level linearly reduced with increasing output voltage from nominal. Maximum reduction is 20% when output voltage is increased to +10%. (ie. a reduction from 125W to 100W)

Above 100W performance criteria B is achieved. This is valid for the two conditions:

- 0% for 1 cycle (100Vac and 240Vac)
- 40% for 10/12 cycles (240Vac)

No load power consumption is only specified at standard nominal output voltage. It may be achieved with increased output voltage but this cannot be guaranteed.

## 3. CONNECTIONS

Input J1 (Standard JST connector)

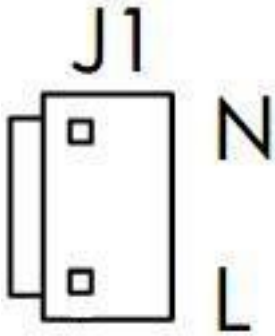

| Pin    | Function J1 |
|--------|-------------|
| Top    | AC Neutral  |
| Bottom | AC Line     |

JST mating connectors and pins

- Mating Housing Part no. VAR-2
- Crimp terminal (20-18AWG) Part no. SVA-41T-P1.1

Input J1 (/M Molex connector)

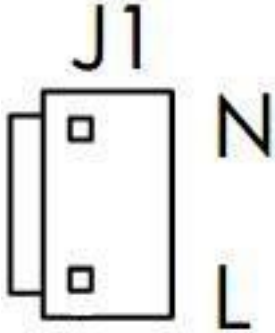

| Pin    | Function J1 |
|--------|-------------|
| Top    | AC Neutral  |
| Bottom | AC Line     |

Molex mating connectors and pins

- Mating Housing Part no. 09-50-1031
- Crimp terminal (24-18AWG) Part no. 08-70-1031

Contact Molex for other crimp terminal types

Output J100 (Standard JST Connector)

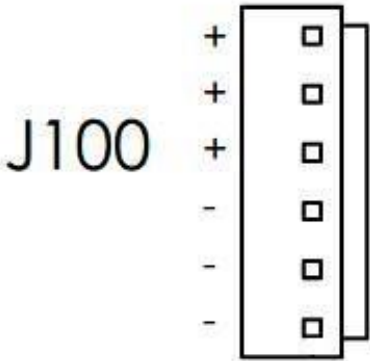

| Pin      | Function J100 |
|----------|---------------|
| Top 3    | Vout +        |
| Bottom 3 | Vout -        |

JST mating connectors and pins

- Mating Housing Part no. VHR-6N
- Crimp terminal (22-18AWG) Part no. SVH-21T-P1.1
- Crimp terminal (20-16AWG) Part no. SVH-41T-P1.1

Output J100 (/M Molex Connector)

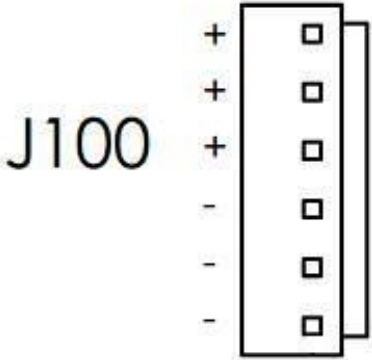

| Pin      | Function J100 |
|----------|---------------|
| Top 3    | Vout +        |
| Bottom 3 | Vout -        |

Molex mating connectors and pins

- Mating Housing Part no. 09-50-1061
- Crimp terminal (24-18AWG) Part no. 08-70-1031

Contact Molex for other crimp terminal types

Earth Ground J2 (Tyco Connector)



| Pin | Function J2      |
|-----|------------------|
| N/A | Protective Earth |

Tyco mating connector

- Crimp terminal (22-18AWG) Part no. 2-520407-2
- Crimp terminal (16-14AWG) Part no. 2-520408-2

Contact Tyco for other crimp terminal types

Fan Supply J101 (Molex Connector)

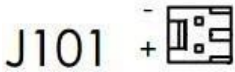

| Pin    | Function J101 |
|--------|---------------|
| Top    | - Output      |
| Bottom | + Output      |

Molex mating connectors and pins

- 2 way Mini-Latch™ with locking ramp Part no. 51191-0200
- Crimp terminal Series 50802

Contact Molex for other crimp terminal types

4. GENERAL OPERATION

EFFICIENCY

The following charts show the typical efficiency of the CUS150M.

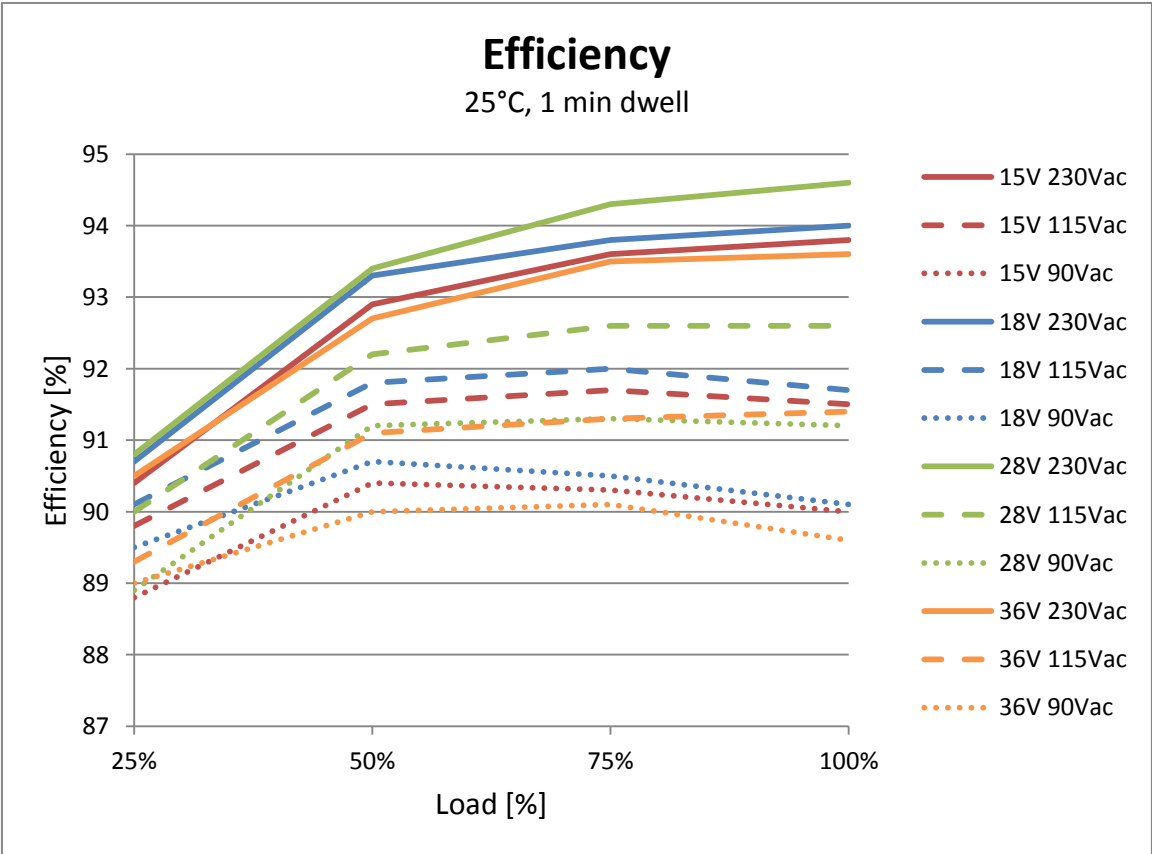
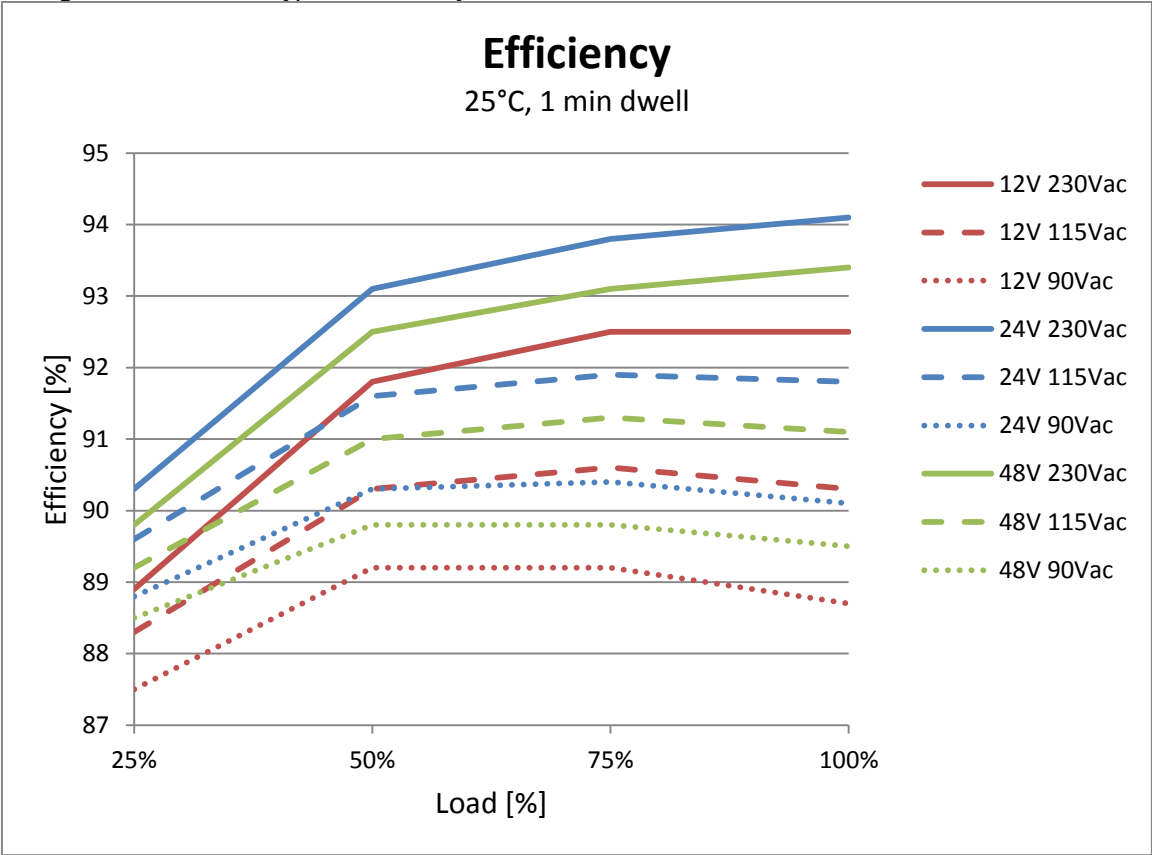

**NO LOAD OPERATION**

No minimum load is required for the power supply to operate within specification.

**CAPACITIVE LOAD OPERATION**

The maximum capacitance that can be connected to the output is as follows:

|                          |         |        |       |       |       |       |       |
|--------------------------|---------|--------|-------|-------|-------|-------|-------|
| Product code             | CUS150M |        |       |       |       |       |       |
| Output Voltage           | 12V     | 15V    | 18V   | 24V   | 28V   | 36V   | 48V   |
| Maximum Capacitance (µF) | 12,500  | 10,000 | 8,333 | 6,250 | 5,360 | 4,170 | 3,130 |

**SERIES CONNECTION**

It is possible to connect multiple CUS150M power supplies in series. Do not exceed 150V for the total voltage of outputs connected in series.

Each CUS150M should have a diode fitted across the output and rated for the output current of the CUS150M.

The outputs connected in series are non-SELV (Safety Extra Low Voltage) if the total output voltage plus 40% of the highest maximum rated output voltage, exceeds 60V (the 40% addition allows for a single fault in any one individual channel).

**PARALLEL CONNECTION**

Outputs must not be connected in parallel as this may cause overheating and reduced field life.



**OUTPUT CHARACTERISTICS**

**RIPPLE AND NOISE**

Ripple and noise is defined as periodic or random signals over a frequency range of 10Hz to 20MHz. Measurement is taken after 60 seconds dwell time. Measurements are to be made with a 20MHz bandwidth oscilloscope. Measurements are taken at the end of a 150mm length of a twisted pair of cables, terminated with a 100nF ceramic capacitor and a 120µF electrolytic capacitor. The earth wire of the oscilloscope probe should be as short as possible; winding a link wire around the earth collar of the probe is the preferred method.

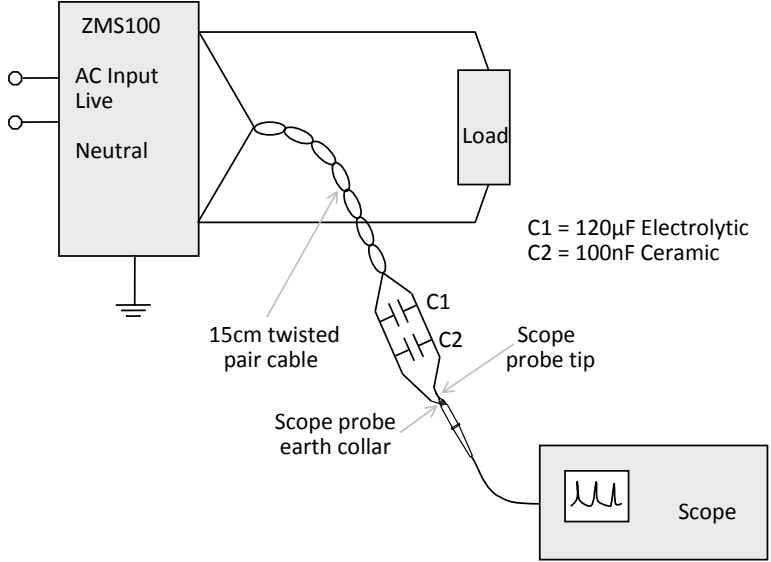

Ripple and Noise Measurement

**TRANSIENT RESPONSE PERFORMANCE**

The transient response specification refers to a 25%-75% load change, 100Hz repetition rate, 50% duty cycle at 25°C ambient temperature

Dynamic Load Response (25°C or higher ambient)

For a 25 to 75% load change the output voltage will remain with 5% of the nominal output voltage. The output will recover to within 2% of the nominal output voltage in  $\leq 1$ ms for a 25 to 75% load change. Additional capacitance can be added across the output which can reduce over/undershoots.

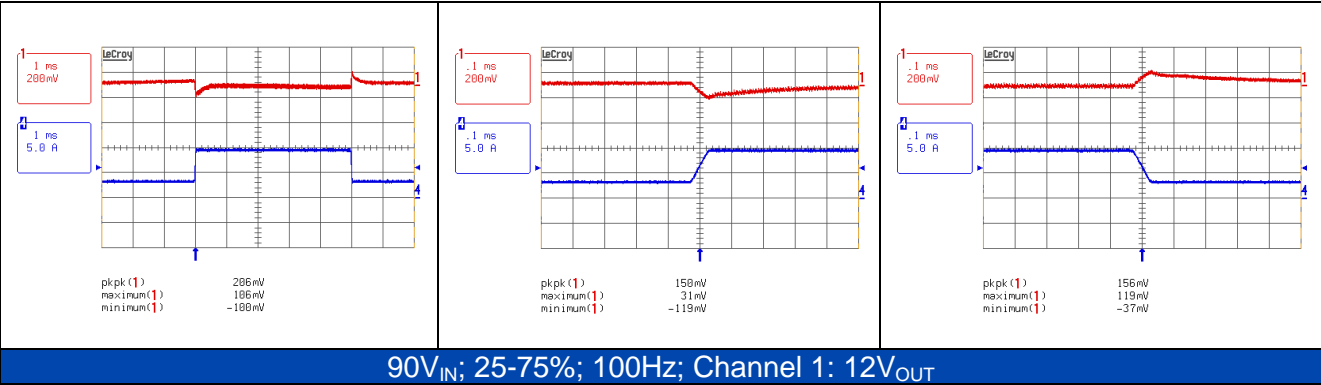

## OUTPUT TIMING

Output timing diagram

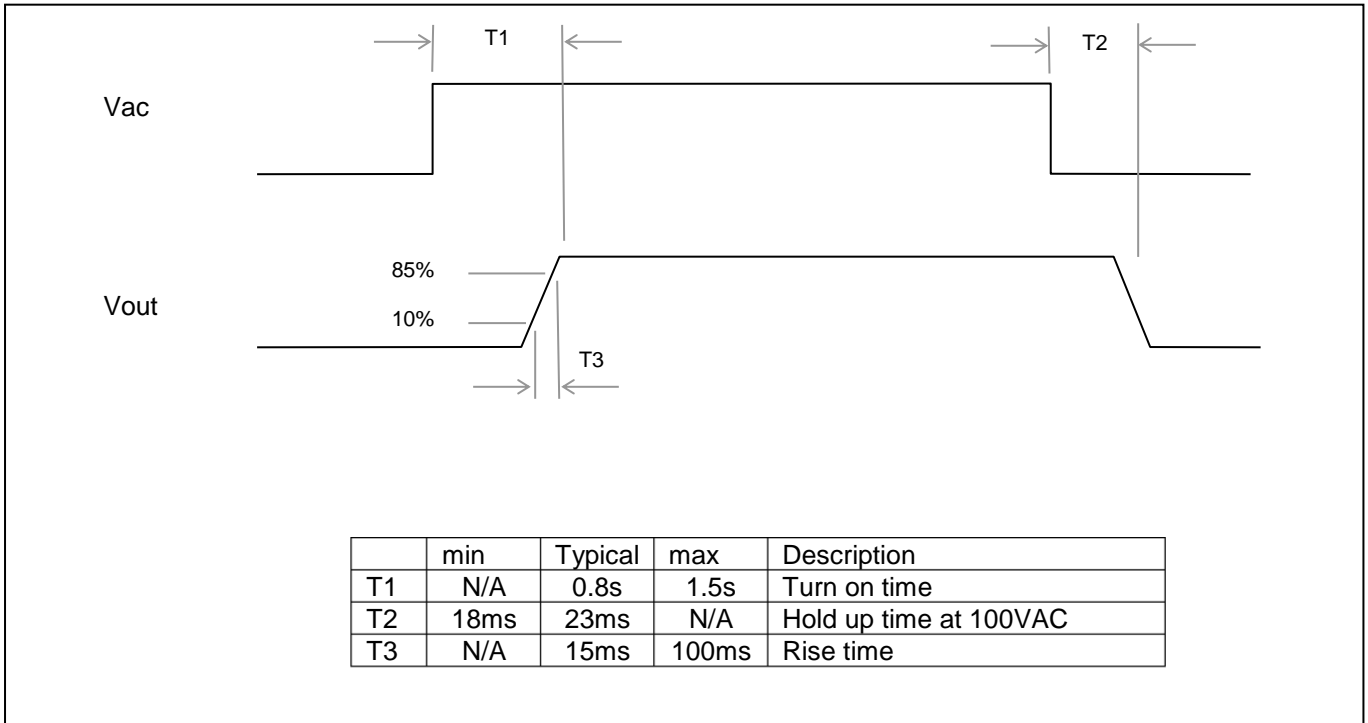

## OVERSHOOT AT TURN-ON AND TURN-OFF

The output voltage overshoot upon the application or removal of the input mains voltage shall be less than 8% (typically 4%) above the nominal voltage. No opposite polarity voltage is present at any time.

The turn on/off characteristics for the CUS150M-xx unit are shown below:

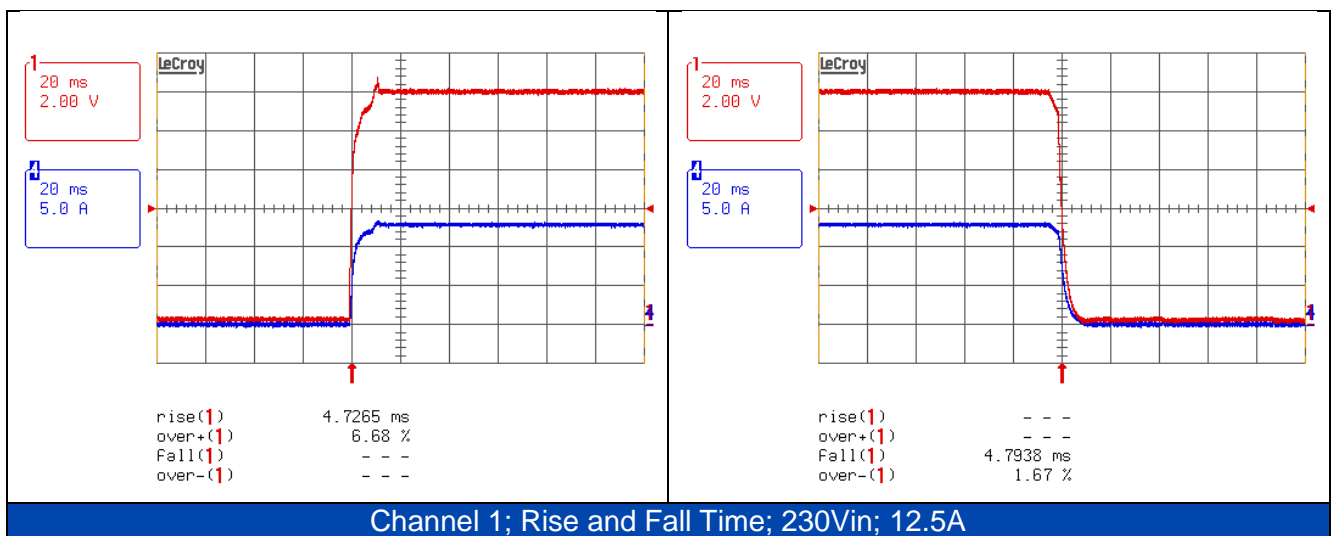

## **OUTPUT PROTECTION**

### **No Load Operation**

The power supply will operate with no load on the output with no damage, hazardous condition or reduction in performance.

### **Over current protection**

If a load is applied which puts the power supply into over current then the power supply will enter a hiccup state. This will turn the output off for typically 200-800ms, then on for typically 35-100ms. This state will continue until the over load is removed.

### **Short-Circuit Protection**

A short circuit is defined as an impedance of  $<0.1$  Ohms placed between the DC return and any output. A short circuit on the output will cause no damage to the power supply and will enter a hiccup state. Note the power supply is not designed to operate continuously in short circuit condition and components may be overheated. The power supply will attempt to restart until the short circuit is removed. After removal of the short circuit, the power supply will maintain normal operation.

### **Over temperature protection**

No specified over temperature protection is provided. As a note, some internal component(s) have internal over temperature protection built in, but this is not to be relied upon to ensure safe, reliable operation.

### **Over voltage protection**

An overvoltage on the output will cause the power supply to shut-down. To restart, remove the ac supply for at least 0.4 seconds and then reapply.

The threshold is 115-140% of standard output voltage for each model and does not alter when output voltage is adjusted. Note that 48V model has maximum threshold 60V.

### 5. COOLING REQUIREMENTS

The maximum continuous rating and power derating for high ambient temperatures of the power supply is specified on the datasheet (model dependant).

Refer to the CUS150M handbook for the test method and components to be monitored to ensure safe, reliable operation.

#### CONVECTION AND CONDUCTION COOLING

On the pictures below are indicated orientations and thermocouple position. It applies to open frame unit and chassis options. Unit under Test (UUT) was positioned 50mm above and in the centre of bottom surface of a test box. Wall of a fixture for vertical orientations was 50 mm away from UUT. Ambient temperature is an average of 4 measurement points positioned 25mm from PCB corners of UUT.

Conduction cooling for chassis options was simulated with UUT attached to a heatsink / cold plate. The size of the heatsink / cold plate was such that chassis temperature rise (temperature measured at U chassis temperature measurement point minus ambient temperature) was below 6°C. No airflow was provided for top side components (they were convection cooled).

Orientation B is the most preferred orientation for the open frame unit (the best cooling and the highest electrolytic capacitor life). The least preferred orientation is the orientation D. Note that the preferences are only informative and may vary in end user application due to surrounding objects and convection airflow around the unit.

⊕ THERMOCOUPLE POSITIONS (USE TYPE K)

A

HORIZONTAL ORIENTATION A

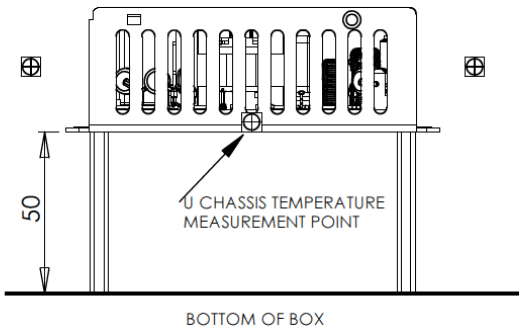

**SIDE VIEW**

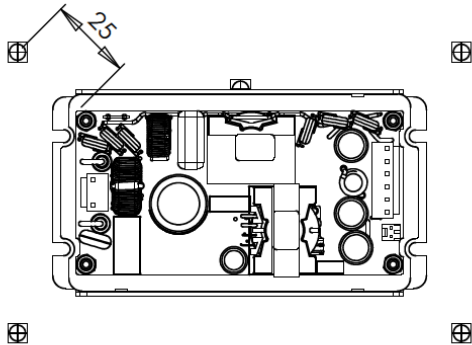

**TOP VIEW**

B VERTICAL ORIENTATION B

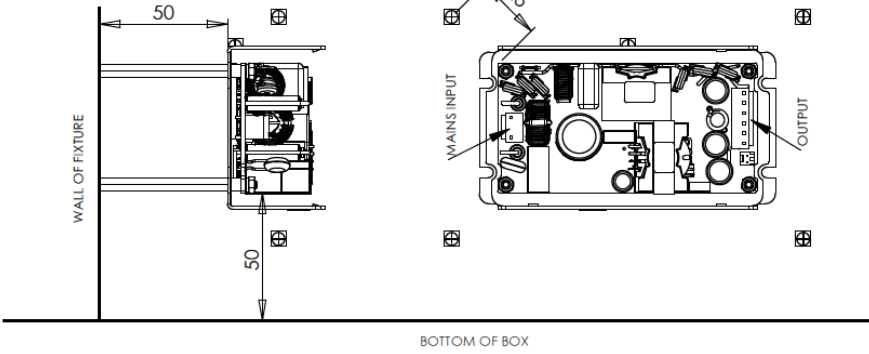

C VERTICAL ORIENTATION C

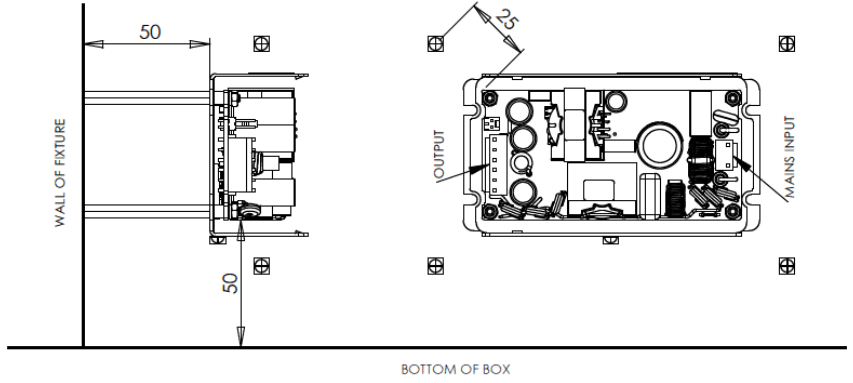

D VERTICAL ORIENTATION D

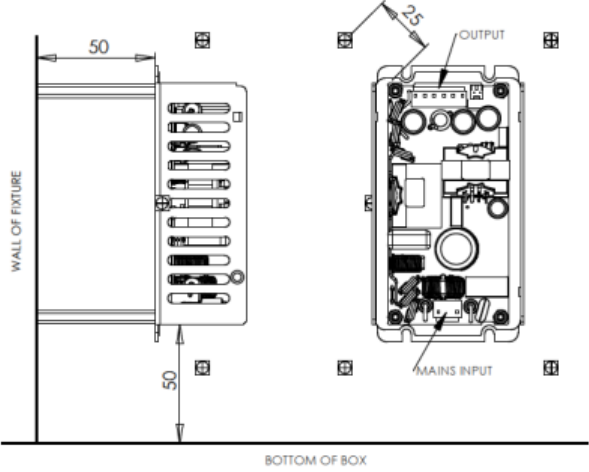

E VERTICAL ORIENTATION E

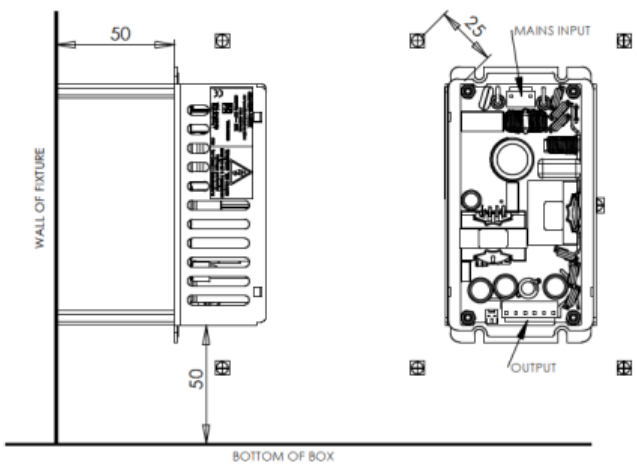

## FORCED AIR COOLING

The amount of airflow required depends upon the applied input voltage, airflow direction and position in end application.

Below are indicated preferred airflow directions for best performance and longest capacitor life.

If the fan output is loaded the PPTC (Polymeric Positive Temperature Coefficient fuse) XTH100 has to be kept below 85°C to prevent false triggering. 85°C is maximum guaranteed temperature for the fuse not to trip.

## APPLIES TO OPEN FRAME ONLY

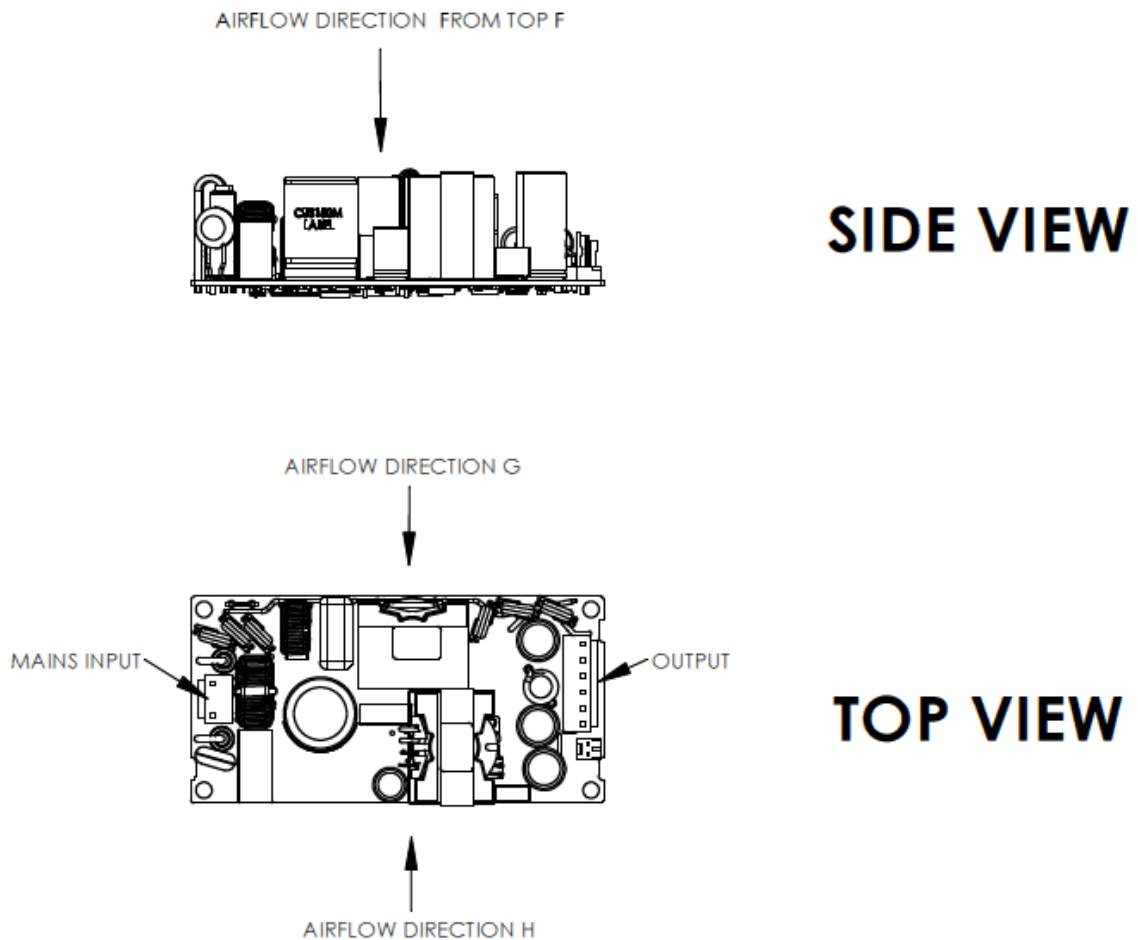

**6. RELIABILITY**

Calculated according to Telcordia SR332 Issue 3, Method I (parts count), Case 3, Ground Benign Controlled, at 30°C.

**MTBF Prediction, Telcordia SR332 Iss 3.  
CUS150M**

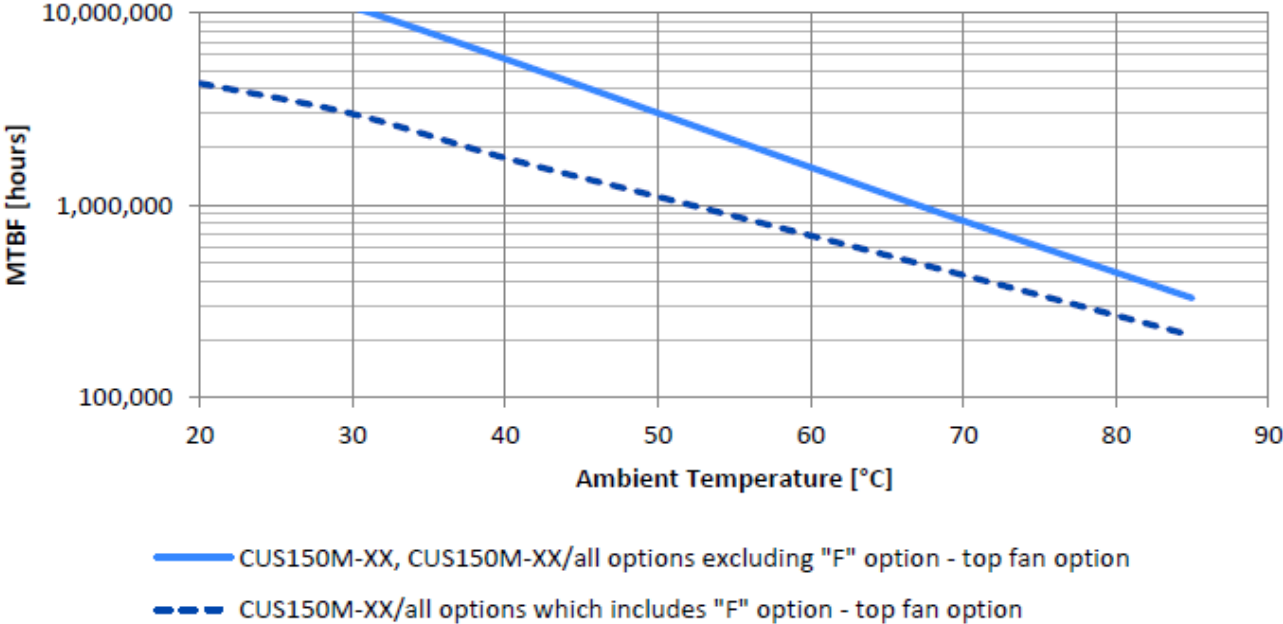

**ELECTROLYTIC CAPACITOR LIFETIMES**

This set of curves will determine capacitor life based on continuous (24/7) operation. Actual temperature values must be measured in the end application and will depend upon the mounting orientation, ambient temperature and airflow speed.

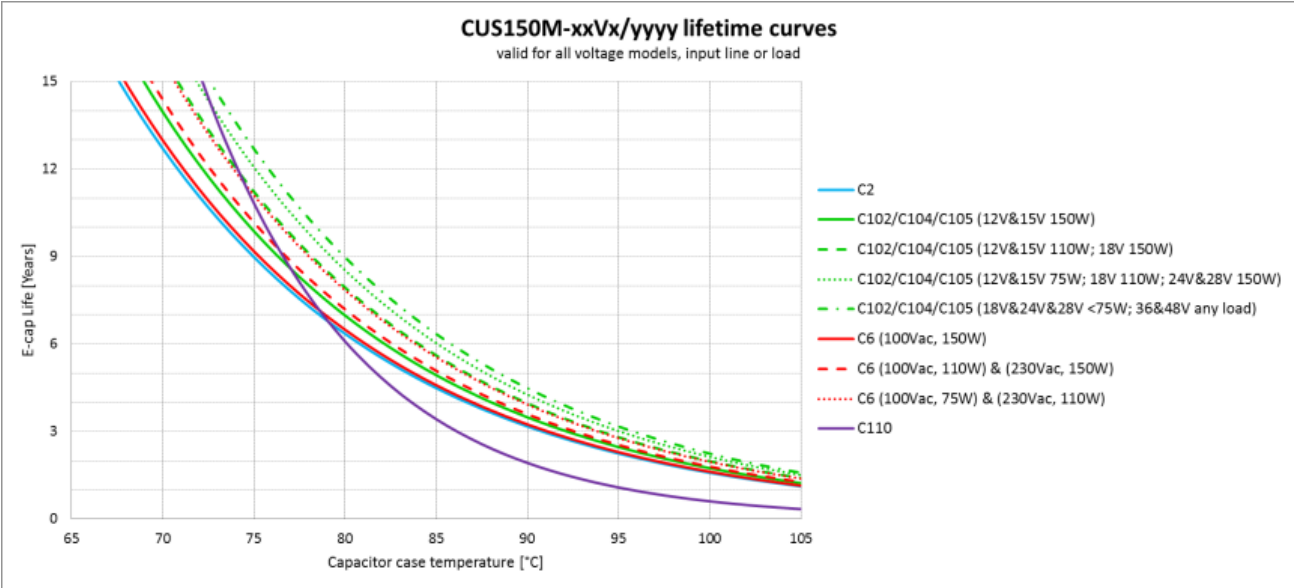

This set of curves determines capacitor life based on continuous (24/7) operation for convection/conduction cooling with respect to ambient temperature

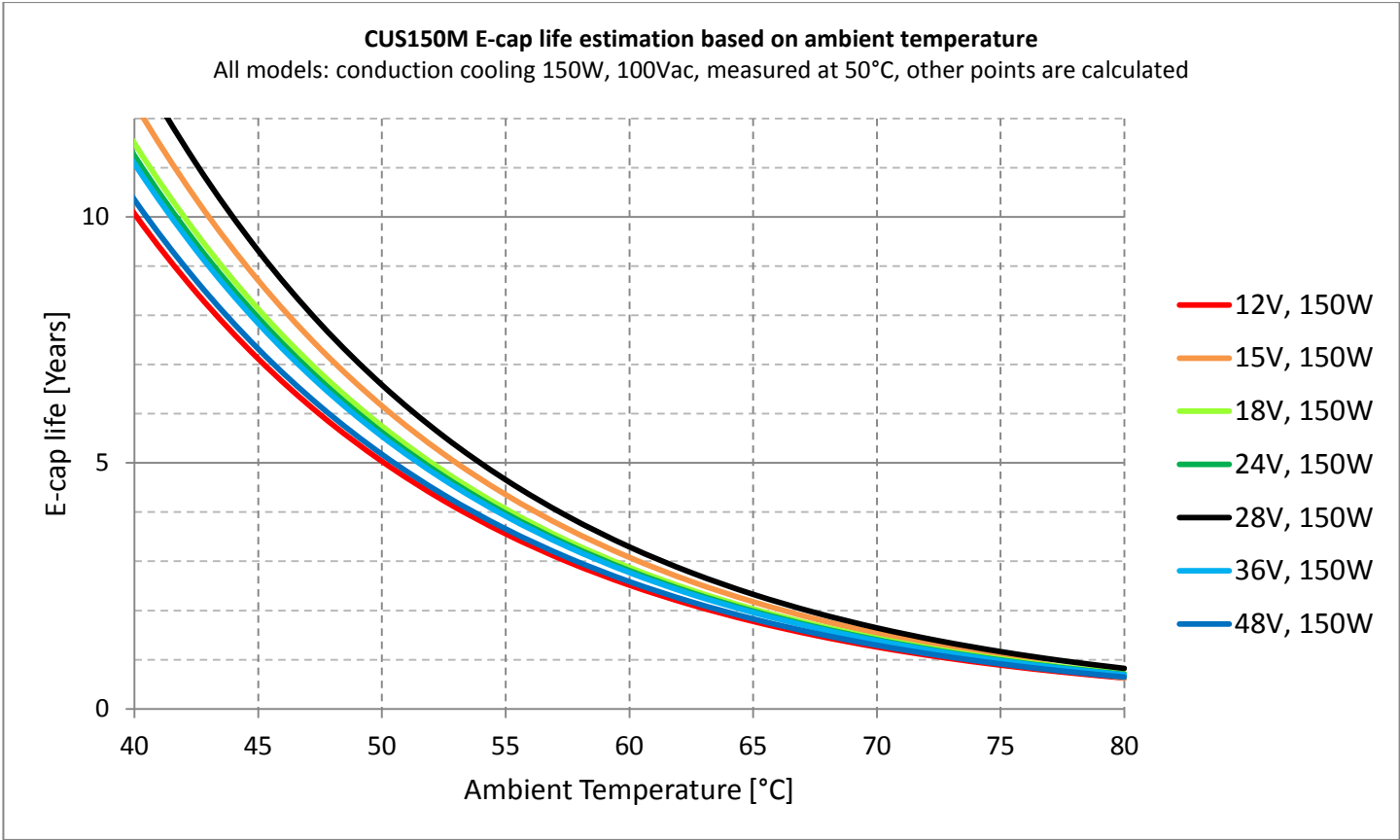
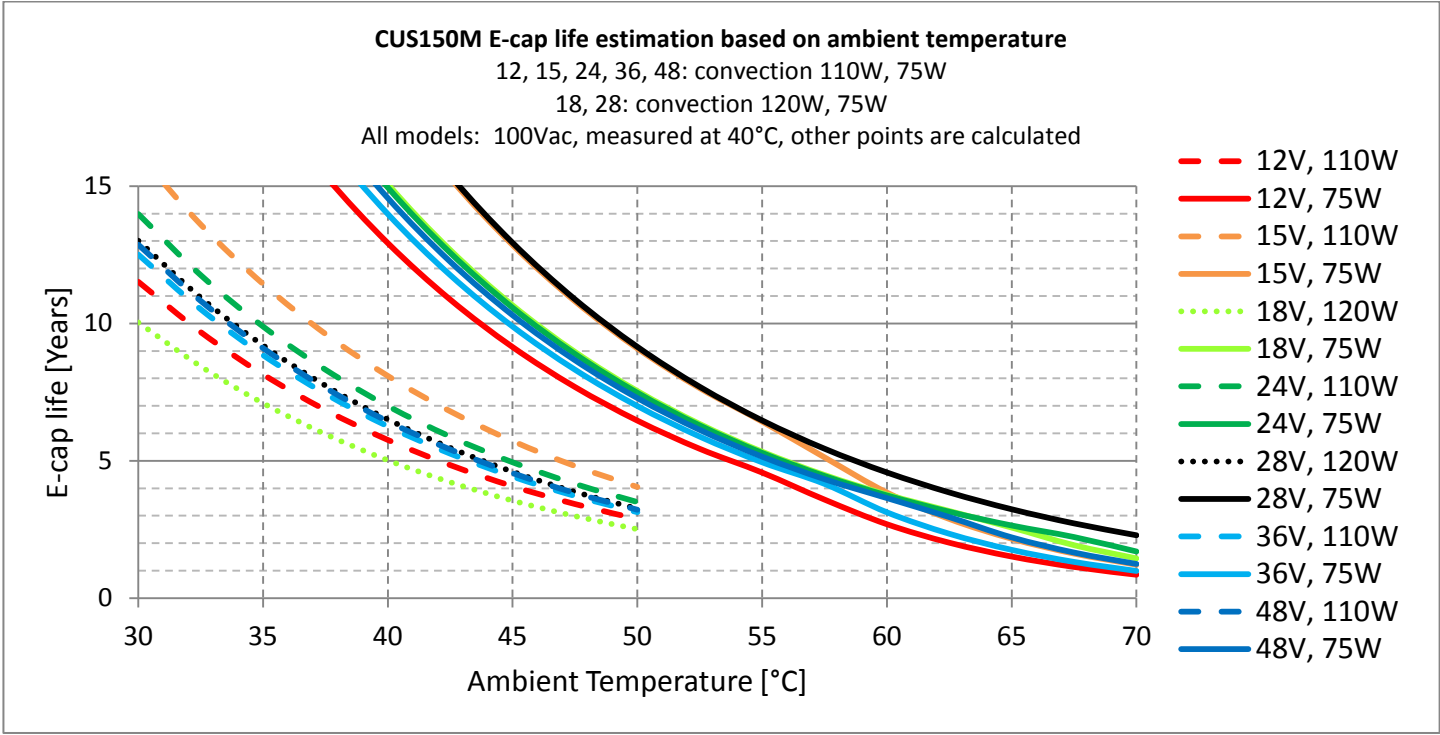



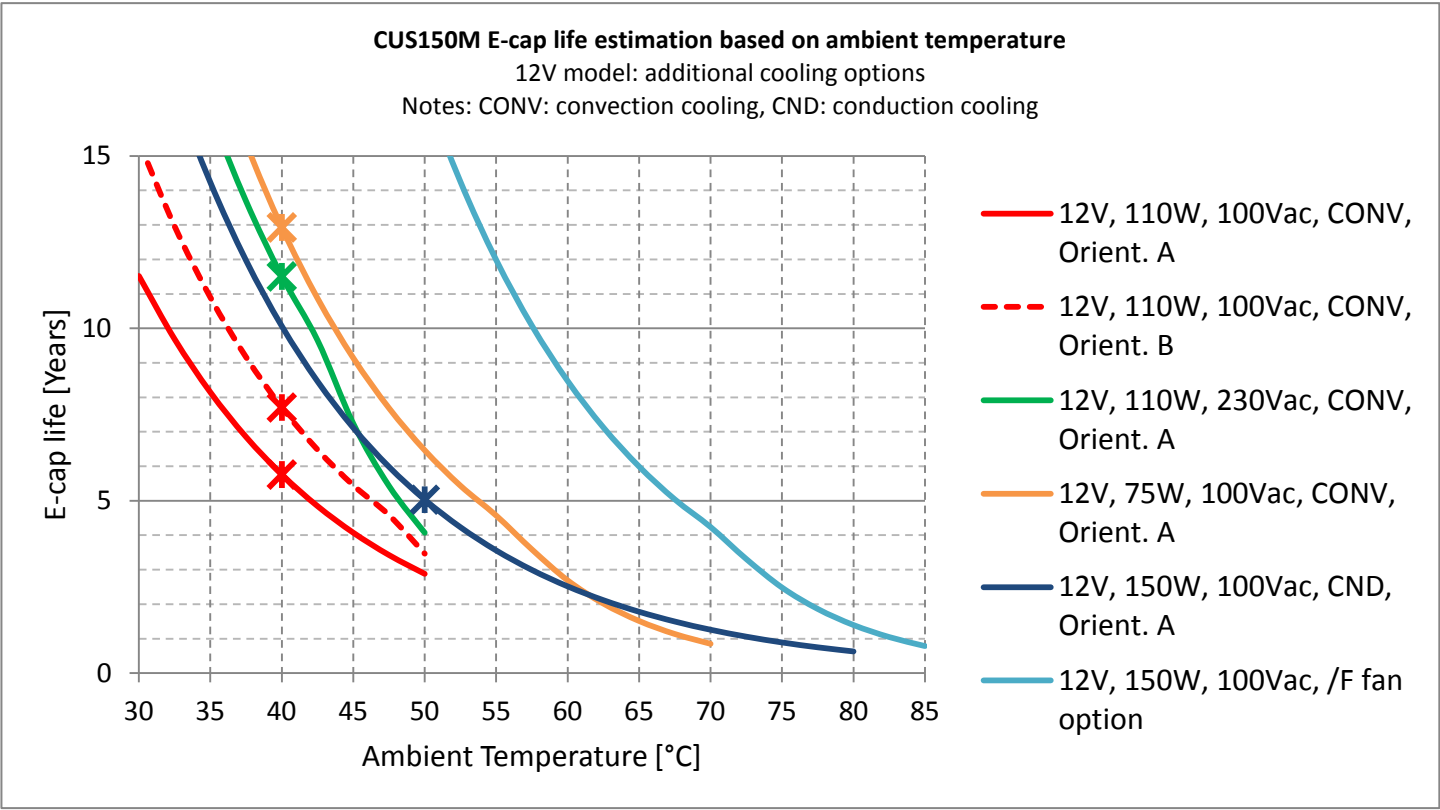

**7. ELECTROMAGNETIC COMPATIBILITY**

Typical Conducted Emissions result for the CUS150M at 230Vac, 150W, Class I

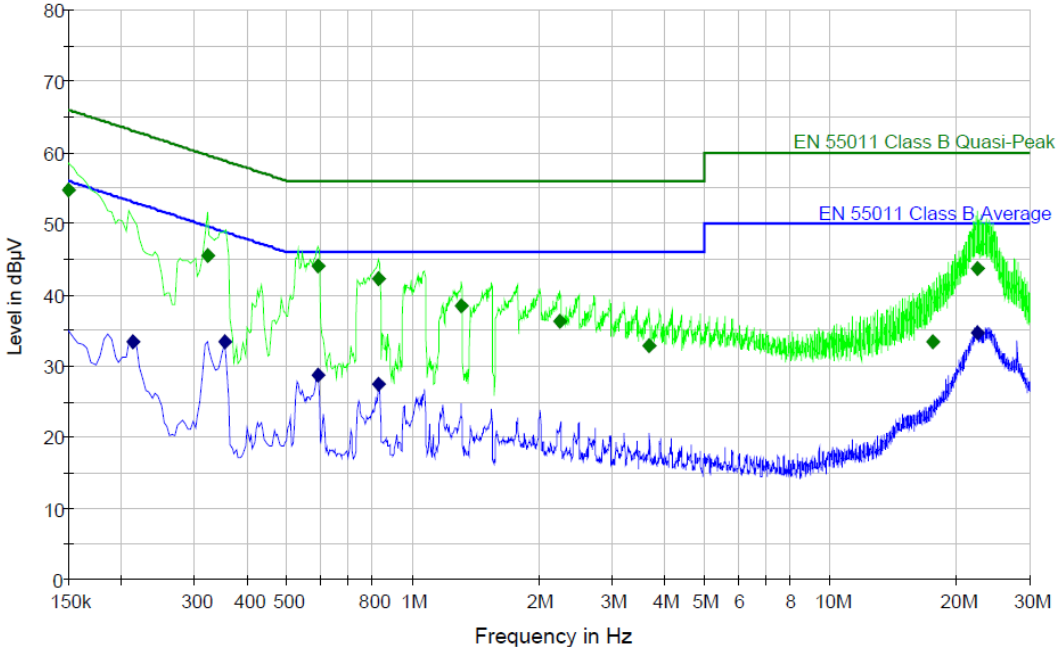

**INSTALLATION FOR OPTIMUM EMC PERFORMANCE**

## **Mounting**

All equipment should ideally be mounted inside an earthed, shielded metal box. Alternatively an earthed metal plate can be used to mount the power supply and load. All four mounting holes (one in each corner) on the CUS150M should be utilised for best electrical and mechanical performance.

The CUS150M can be operated as a Class II power supply (without a ground connection).

The radiated and conducted emissions of CUS150M were tested with a baseplate under the power supply to achieve Class B limits. The baseplate simulates a metal chassis in a Class I configuration.

The following instructions can help to achieve Class B limits also with an open frame unit (however it is dependent on the actual application and installation);

- Add ferrite clamp on to fan output leads if used.
- Add ferrite clamp such as TDK ZCAT1325-0530A or ZCAT2235-1030A on to input cable, output cable or both.
- Add external mains input filter such as EPCOS filter B84771M0003A000 or if medical leakage is not required EPCOS filter B84771A0003A000
- Run the power supply below its full load capacity
- A combination of any of the above.

Please refer to handbook for allowable orientations.

To maintain safe creepage and clearance distances, the maximum diameter of the mounting standoff is 5.4mm and the maximum diameter of the top side washer under the mounting screw is 6mm.

## **Cables**

All cables (both AC input and DC output) should be run as close as possible to the earthed metal box/plane. AC input cable should be a twisted group laid as flat to the earthed metal box/plane as possible.

All output cables should be routed as far away from the input cables as possible. If the input and output cables must be run close to each other screen one (or ideally both).

The positive and negative supply cables should be twisted together.

All cable run loops should be kept as small as possible (this should be implemented in the system PCB design also).

## **Earth star point**

Where the AC supply enters the equipment, this should be taken to a 'star point' chassis mounted earth point (Note for compliance with EN60950-1 requires the main protective earth to have its own dedicated spring washer and nut) as close as possible to the mains inlet. All other earth points should be taken back to this point only.

## **Switching frequency**

The CUS150M has a variable switching frequency ranging from 20kHz to 220kHz, depending upon the input voltage, output voltage and output load.

## **8. WEIGHT**

The CUS150M weighs (open frame / U-option / A-option / F-option / B-option): 185g / 245g / 260g / 270g / 225g